

	Nordjysk mesterskab 2019	Aalborg Skyttekreds																																		
Prøve 	<table style="width:100%; border-collapse: collapse;"> <tr><td>1:</td><td>9.6</td><td style="text-align: right;">↗</td></tr> <tr><td>2:</td><td>9.7</td><td style="text-align: right;">↗</td></tr> <tr><td>3:</td><td>10.0</td><td style="text-align: right;">↑</td></tr> <tr><td>4:</td><td>9.9</td><td style="text-align: right;">↘</td></tr> <tr><td>5:</td><td>10.3</td><td style="text-align: right;">↘</td></tr> <tr><td>6:</td><td>9.9</td><td style="text-align: right;">↖</td></tr> <tr><td>7:</td><td>10.7x</td><td style="text-align: right;">↗</td></tr> <tr><td>8:</td><td>10.8x</td><td style="text-align: right;">↘</td></tr> <tr><td>9:</td><td>10.8x</td><td style="text-align: right;">↘</td></tr> <tr><td>10:</td><td>10.5</td><td style="text-align: right;">↗</td></tr> </table>	1:	9.6	↗	2:	9.7	↗	3:	10.0	↑	4:	9.9	↘	5:	10.3	↘	6:	9.9	↖	7:	10.7x	↗	8:	10.8x	↘	9:	10.8x	↘	10:	10.5	↗	<table style="width:100%; border-collapse: collapse;"> <tr><td style="text-align: right;">Serie</td><td style="text-align: right;">96 (3x)</td></tr> <tr><td style="text-align: right;">Total</td><td style="text-align: right;">0 (0x)</td></tr> </table>	Serie	96 (3x)	Total	0 (0x)
1:	9.6	↗																																		
2:	9.7	↗																																		
3:	10.0	↑																																		
4:	9.9	↘																																		
5:	10.3	↘																																		
6:	9.9	↖																																		
7:	10.7x	↗																																		
8:	10.8x	↘																																		
9:	10.8x	↘																																		
10:	10.5	↗																																		
Serie	96 (3x)																																			
Total	0 (0x)																																			
20 Skud 	<table style="width:100%; border-collapse: collapse;"> <tr><td>1:</td><td>10.3</td><td style="text-align: right;">↗</td></tr> <tr><td>2:</td><td>10.6x</td><td style="text-align: right;">↘</td></tr> <tr><td>3:</td><td>10.2</td><td style="text-align: right;">↗</td></tr> <tr><td>4:</td><td>10.7x</td><td style="text-align: right;">↘</td></tr> <tr><td>5:</td><td>10.2</td><td style="text-align: right;">↘</td></tr> <tr><td>6:</td><td>10.1</td><td style="text-align: right;">↖</td></tr> <tr><td>7:</td><td>10.7x</td><td style="text-align: right;">→</td></tr> <tr><td>8:</td><td>10.5</td><td style="text-align: right;">↘</td></tr> <tr><td>9:</td><td>10.6x</td><td style="text-align: right;">→</td></tr> <tr><td>10:</td><td>10.2</td><td style="text-align: right;">↗</td></tr> </table>	1:	10.3	↗	2:	10.6x	↘	3:	10.2	↗	4:	10.7x	↘	5:	10.2	↘	6:	10.1	↖	7:	10.7x	→	8:	10.5	↘	9:	10.6x	→	10:	10.2	↗	<table style="width:100%; border-collapse: collapse;"> <tr><td style="text-align: right;">Serie</td><td style="text-align: right;">100 (4x)</td></tr> <tr><td style="text-align: right;">Total</td><td style="text-align: right;">100 (4x)</td></tr> </table>	Serie	100 (4x)	Total	100 (4x)
1:	10.3	↗																																		
2:	10.6x	↘																																		
3:	10.2	↗																																		
4:	10.7x	↘																																		
5:	10.2	↘																																		
6:	10.1	↖																																		
7:	10.7x	→																																		
8:	10.5	↘																																		
9:	10.6x	→																																		
10:	10.2	↗																																		
Serie	100 (4x)																																			
Total	100 (4x)																																			
20 Skud 	<table style="width:100%; border-collapse: collapse;"> <tr><td>11:</td><td>10.5</td><td style="text-align: right;">↗</td></tr> <tr><td>12:</td><td>10.7x</td><td style="text-align: right;">↖</td></tr> <tr><td>13:</td><td>10.4</td><td style="text-align: right;">←</td></tr> <tr><td>14:</td><td>10.0</td><td style="text-align: right;">←</td></tr> <tr><td>15:</td><td>10.4</td><td style="text-align: right;">↘</td></tr> <tr><td>16:</td><td>10.9x</td><td style="text-align: right;">↑</td></tr> <tr><td>17:</td><td>10.3</td><td style="text-align: right;">↘</td></tr> <tr><td>18:</td><td>10.7x</td><td style="text-align: right;">↑</td></tr> <tr><td>19:</td><td>9.9</td><td style="text-align: right;">↑</td></tr> <tr><td>20:</td><td>10.5</td><td style="text-align: right;">↘</td></tr> </table>	11:	10.5	↗	12:	10.7x	↖	13:	10.4	←	14:	10.0	←	15:	10.4	↘	16:	10.9x	↑	17:	10.3	↘	18:	10.7x	↑	19:	9.9	↑	20:	10.5	↘	<table style="width:100%; border-collapse: collapse;"> <tr><td style="text-align: right;">Serie</td><td style="text-align: right;">99 (3x)</td></tr> <tr><td style="text-align: right;">Total</td><td style="text-align: right;">199 (7x)</td></tr> </table>	Serie	99 (3x)	Total	199 (7x)
11:	10.5	↗																																		
12:	10.7x	↖																																		
13:	10.4	←																																		
14:	10.0	←																																		
15:	10.4	↘																																		
16:	10.9x	↑																																		
17:	10.3	↘																																		
18:	10.7x	↑																																		
19:	9.9	↑																																		
20:	10.5	↘																																		
Serie	99 (3x)																																			
Total	199 (7x)																																			

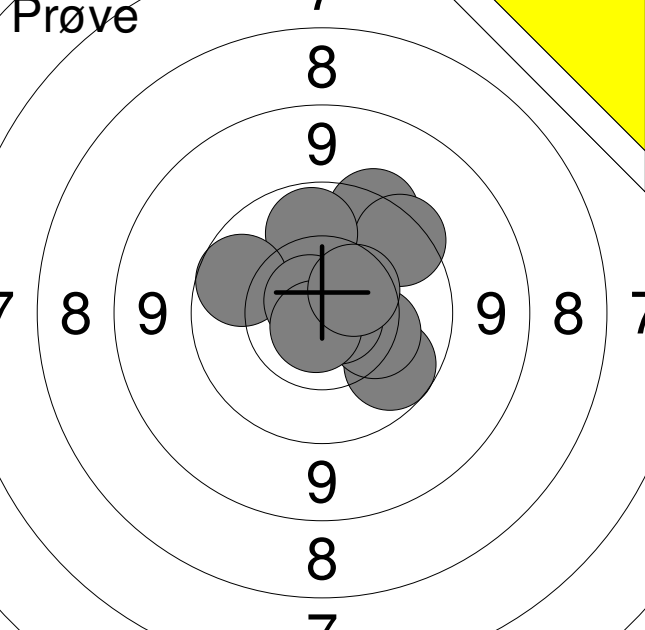

1: 10.1 ↗	6: 10.2 ↗	Serie 100 (2x)
2: 10.2 ↑	7: 10.2 →	
3: 10.7x →	8: 10.4 ↗	Total 0 (0x)
4: 10.5 ↗	9: 10.7x ↖	
5: 10.4 ↗	10: 10.2 ↓	

11: 10.3 ↓	16: 10.8x ↘	Serie 70 (3x)
12: 10.6 ↙	17: 10.9x ↗	
13: 10.5 ↓		Total 0 (0x)
14: 10.3 →		
15: 10.8x ↙		

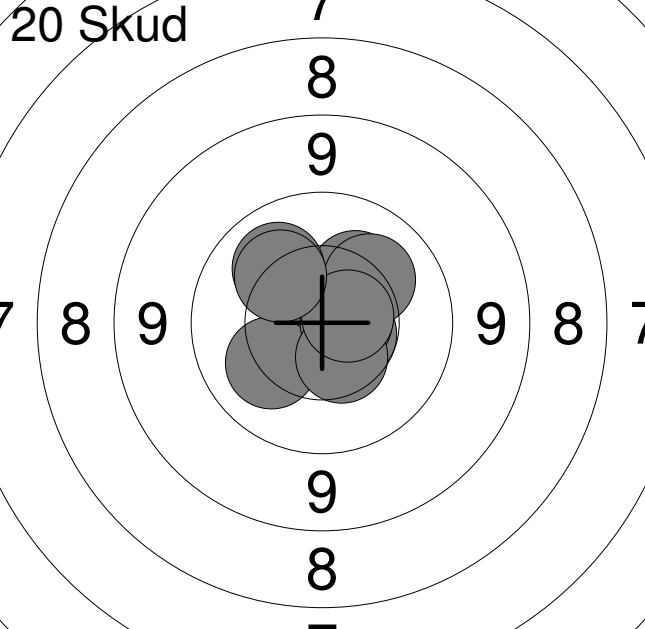
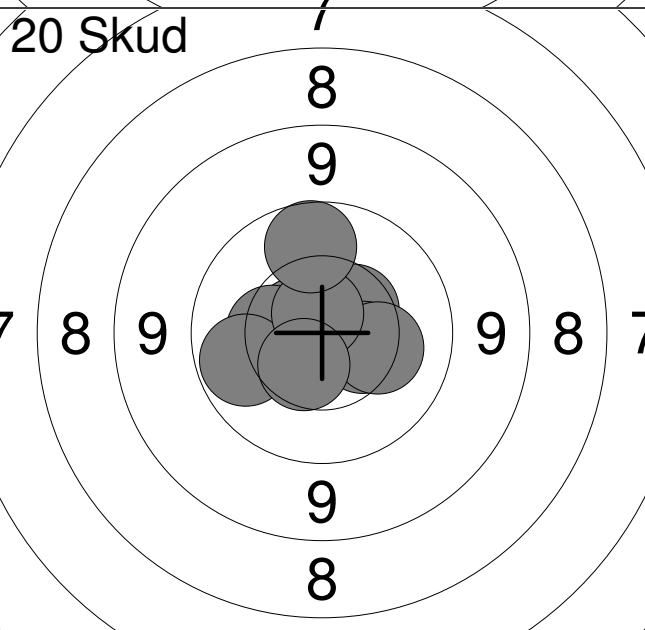
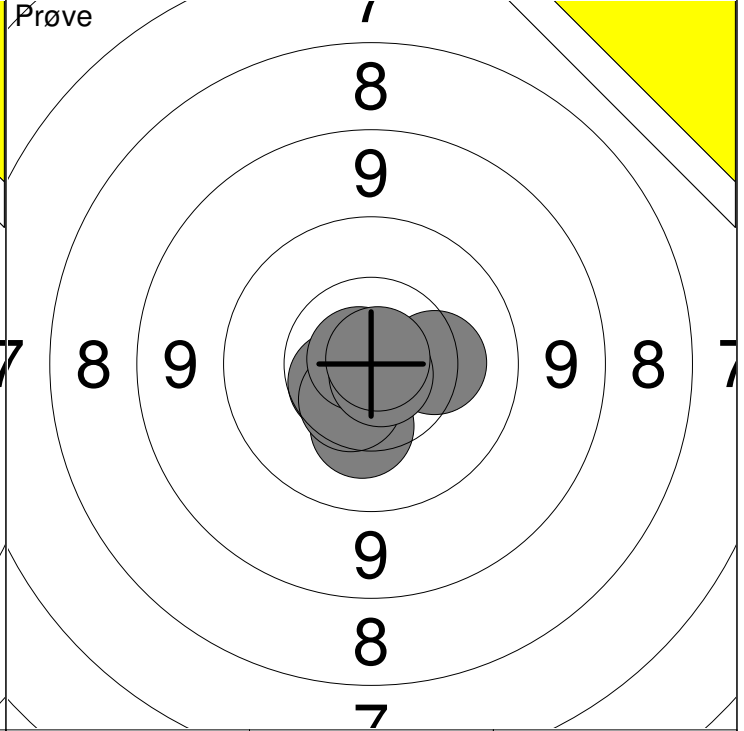
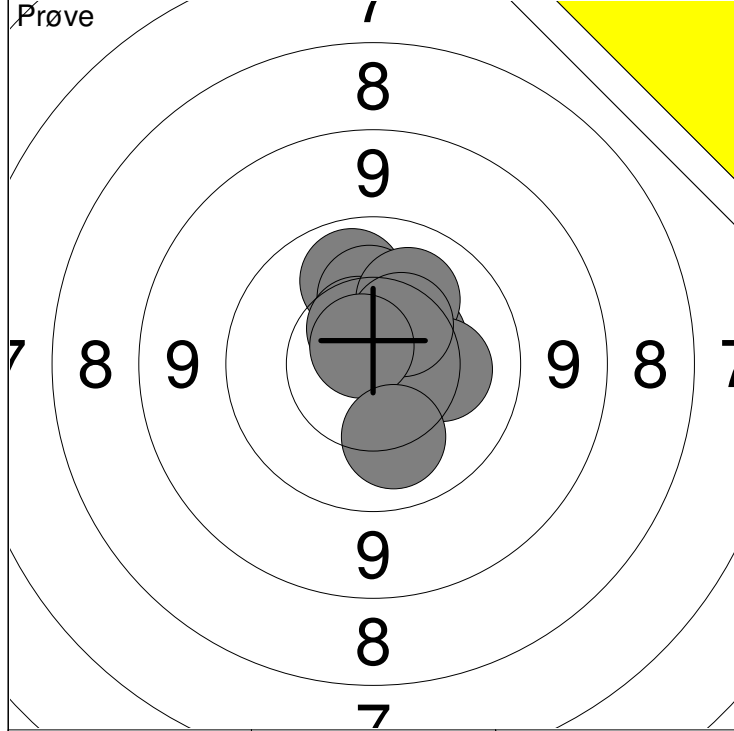
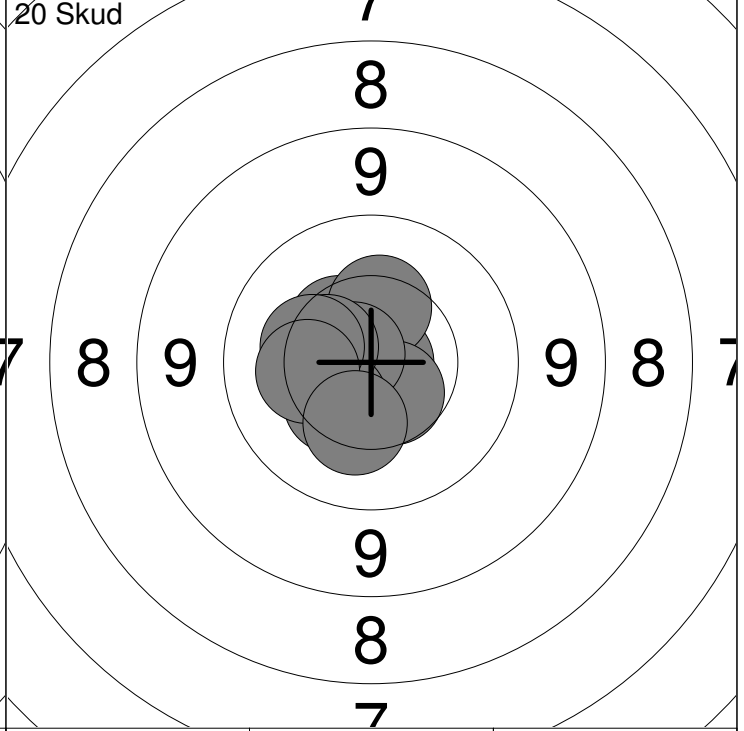
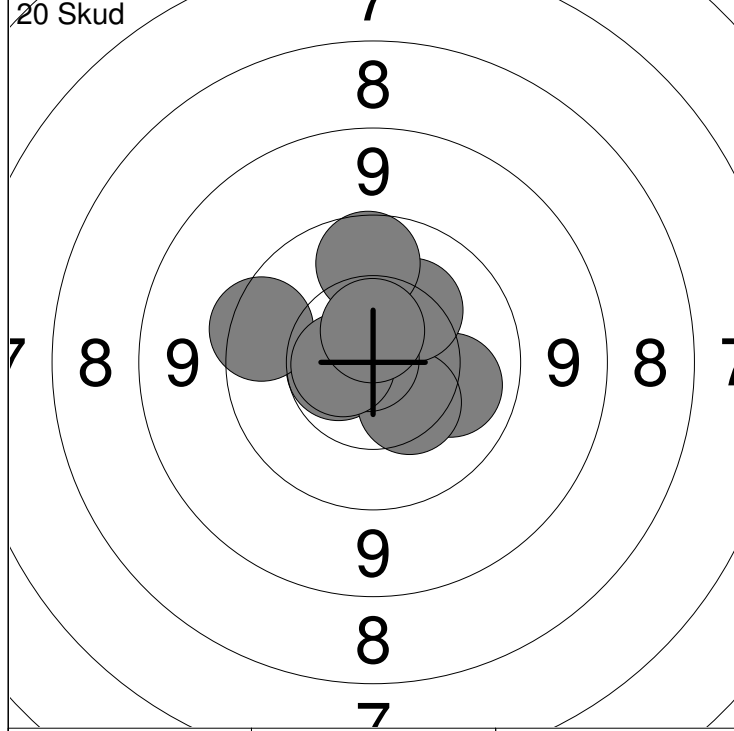

1: 10.7x →	6: 10.9x ↙	Serie 98 (4x)
2: 10.1 →	7: 9.9 ↑	
3: 10.6 ←	8: 9.7 ←	Total 98 (4x)
4: 10.4 ↘	9: 10.6x ←	
5: 10.3 ↗	10: 10.6x ↑	

11: 10.8x →	16: 10.4 ↙	Serie 100 (2x)
12: 10.5 ↗	17: 10.5 ↙	
13: 10.4 ↑	18: 10.3 ←	Total 198 (6x)
14: 10.6 ↘	19: 10.3 ←	
15: 10.7x ↙	20: 10.3 ↓	

Hold 21	Skive 3	Johanne Axelsen	
15 meter		Vester Hassing Skytteforening	BK1
		Nordjysk mesterskab 2019	Aalborg Skyttekreds
Prøve 	1	10.2	→
	8	10.4	↘
	9	10.4	↓
	7 8 9 9 8 7	10.7x	↑
	9	10.7x	→
	8	10.2	→
	9	10.8x	←
	8	10.6	↑
	9	10.1	↘
	8	10.9x	↓
	Serie		100 (4x)
Total		0 (0x)	
20 Skud 	1	10.5	↓
	8	10.1	↓
	9	10.4	↓
	7 8 9 9 8 7	10.5	↘
	9	10.3	↑
	8	10.8x	↘
	9	10.7x	↗
	8	10.5	→
	9	10.8x	↑
	8	10.3	↙
	Serie		100 (3x)
Total		100 (3x)	
20 Skud 	11	10.7x	←
	8	10.8x	↑
	9	10.4	↑
	7 8 9 9 8 7	10.8x	↑
	9	10.2	↖
	8	10.2	←
	9	10.5	←
	8	10.6x	↑
	9	10.3	↑
	8	10.7x	↑
	Serie		100 (5x)
Total		200 (8x)	

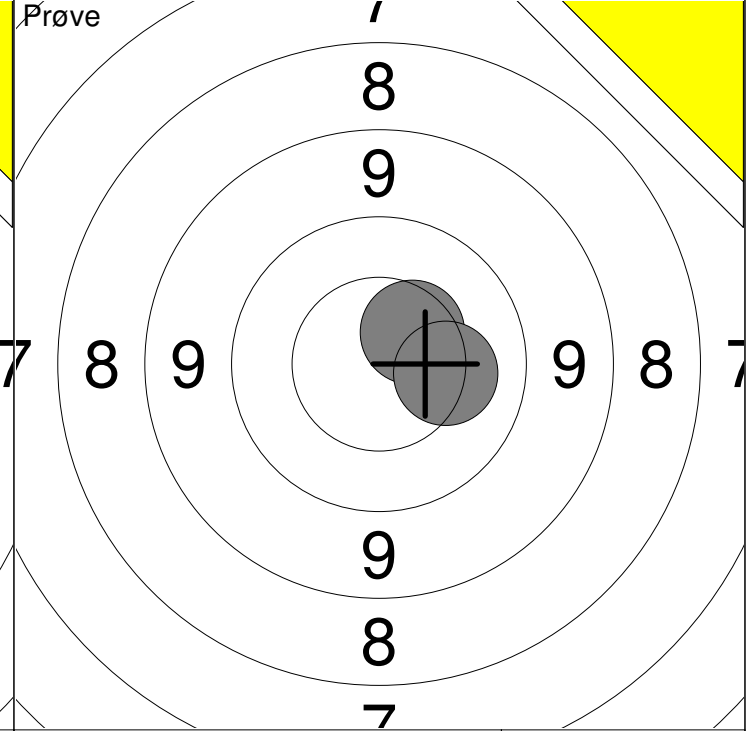
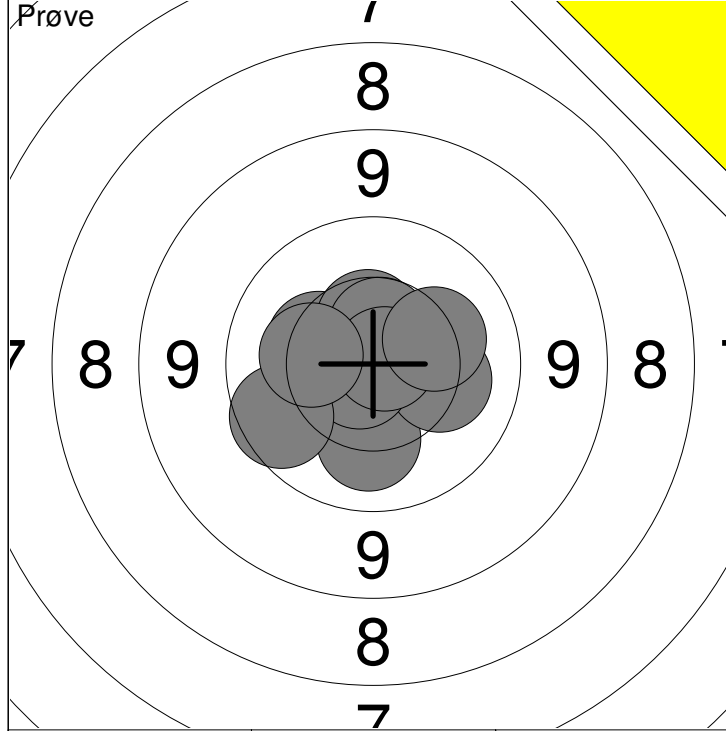

1: 10.2 ↓	6: 10.6 ↑	Serie 99 (2x)
2: 10.2 →	7: 9.8 ←	
3: 10.3 ←	8: 10.8x →	Total 0 (0x)
4: 10.5 ↑	9: 10.3 →	
5: 10.8x ↙	10: 10.3 ←	

11: 10.5 ↗	Serie 20 (0x)
12: 10.2 →	
Total 0 (0x)	

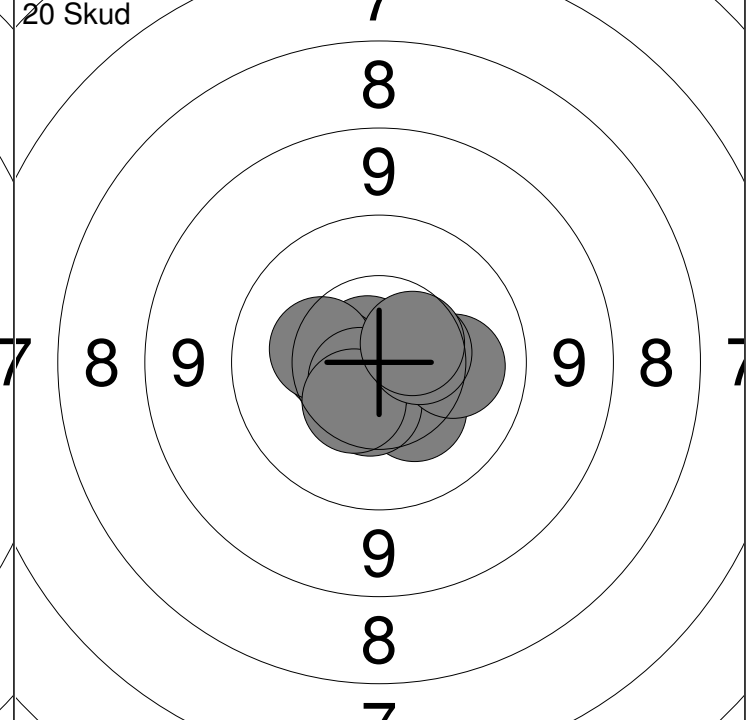
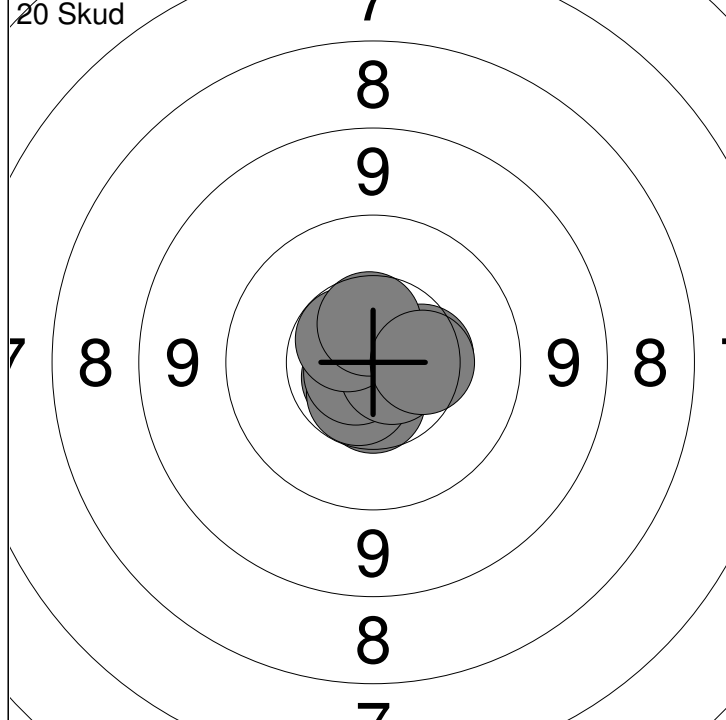

1: 10.7x ↙	6: 10.7x →	Serie 100 (6x)
2: 10.8x ↑	7: 10.4 →	
3: 10.5 ↓	8: 10.6x ↗	Total 100 (6x)
4: 10.6x ↘	9: 10.5 ↑	
5: 10.7x ↙	10: 10.4 →	

11: 10.8x ↗	16: 10.7x ↙	Serie 100 (2x)
12: 10.3 ↓	17: 10.2 →	
13: 10.5 ↓	18: 10.5 ↘	Total 200 (8x)
14: 10.5 ←	19: 10.5 →	
15: 10.3 ←	20: 10.5 ↗	

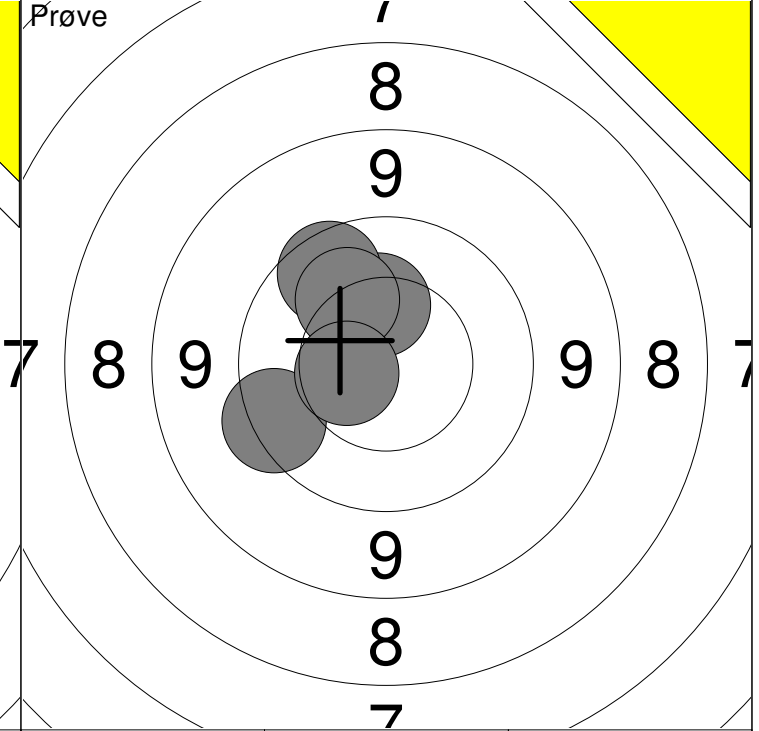
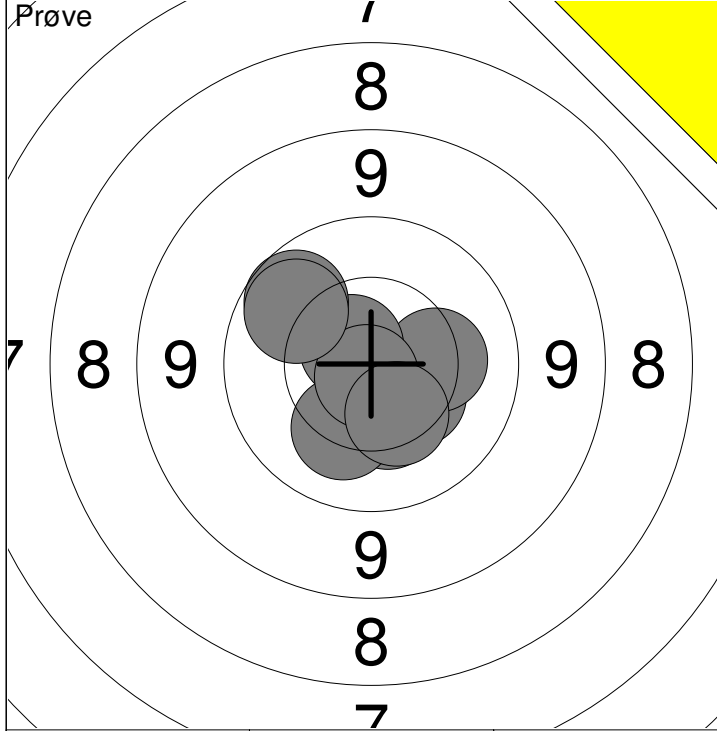

1: 10.4 ↘	6: 9.9 ↖	Serie 99 (2x)
2: 10.3 →	7: 10.2 ↓	
3: 10.4 ↓	8: 10.8x ↓	Total 0 (0x)
4: 10.4 ↓	9: 10.4 ↓	
5: 10.7x ↗	10: 10.0 ↖	

11: 10.3 ↗	16: 10.5 ←	Serie 58 (0x)
12: 10.3 ↑	13: 9.6 ←	
14: 9.8 ↗	15: 10.2 ↗	Total 0 (0x)

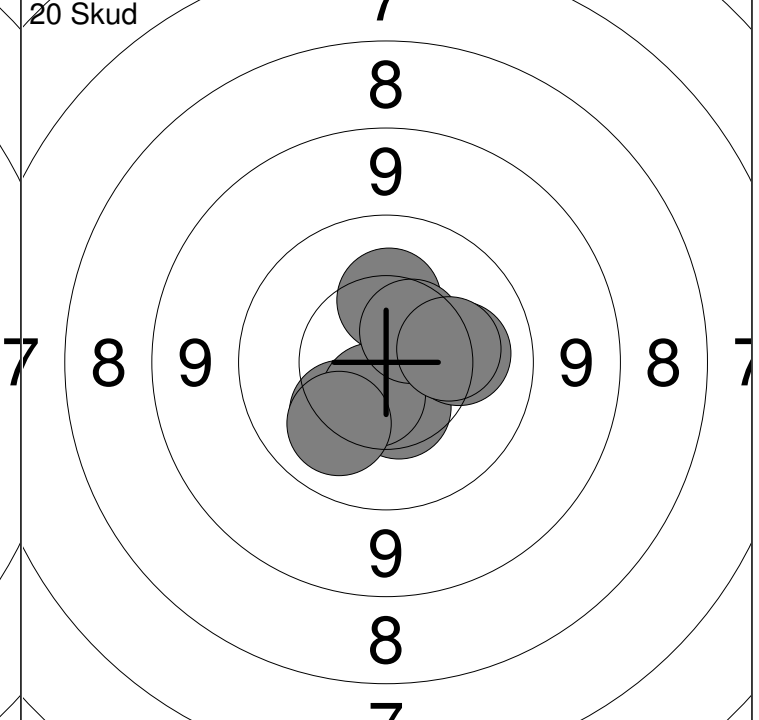
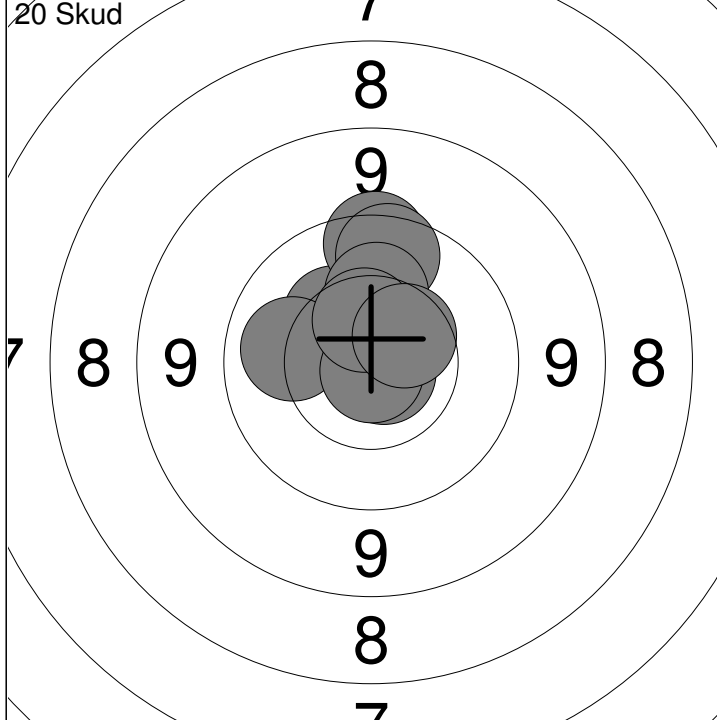

1: 10.4 ↗	6: 9.8 ↑	Serie 98 (2x)
2: 10.8x ↓	7: 10.9x ↓	
3: 10.3 ↗	8: 10.2 ↑	Total 98 (2x)
4: 10.1 ←	9: 10.5 ↑	
5: 9.7 ↑	10: 10.5 ↗	

11: 10.3 ↑	16: 10.6 ↓	Serie 100 (1x)
12: 10.7x ↓	17: 10.1 ↓	
13: 10.5 ↓	18: 10.5 ↗	Total 198 (3x)
14: 10.5 ↓	19: 10.2 →	
15: 10.2 ↘	20: 10.3 →	

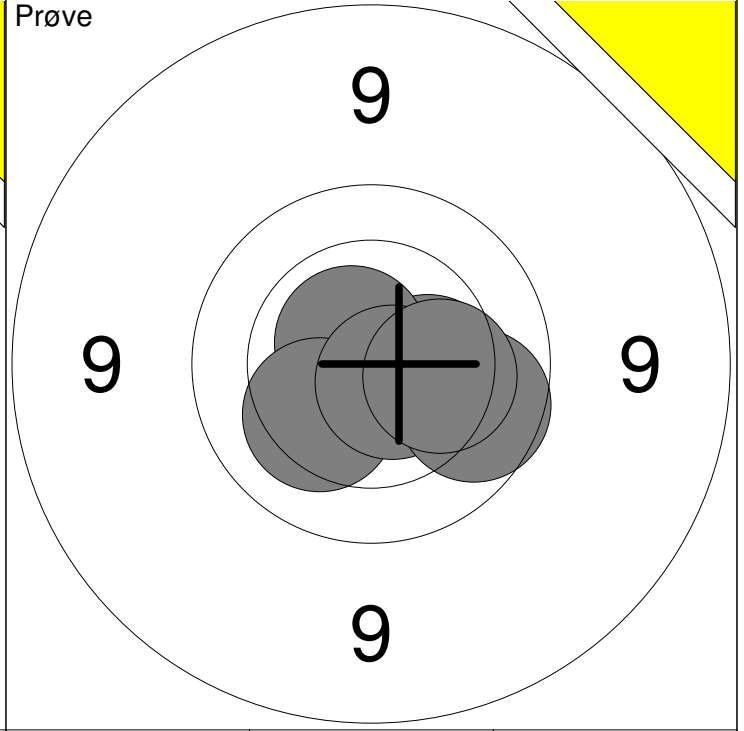
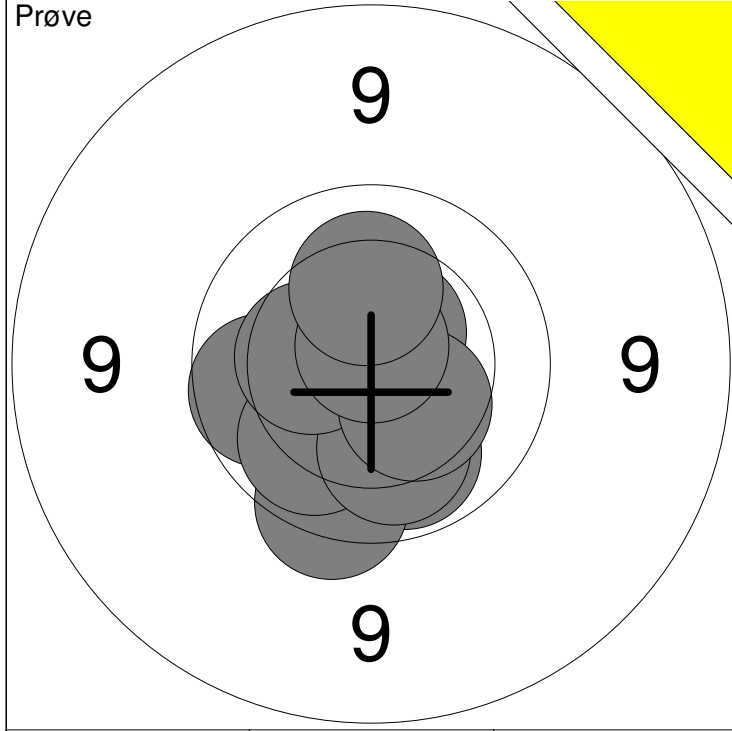

1: 9.9 ←	6: 10.4 ←	Serie 98 (2x)
2: 10.0 ↓	7: 10.6x ↗	
3: 9.7 ↓	8: 10.4 ↘	Total 0 (0x)
4: 10.0 ↙	9: 10.8x ↑	
5: 10.1 ↓	10: 10.2 ↑	

11: 10.4 →	17: 10.3 →	Serie 59 (2x)
12: 10.7x ↗		
13: 10.2 ↙		Total 0 (0x)
14: 10.7x ↘		
16: 9.9 ↘		

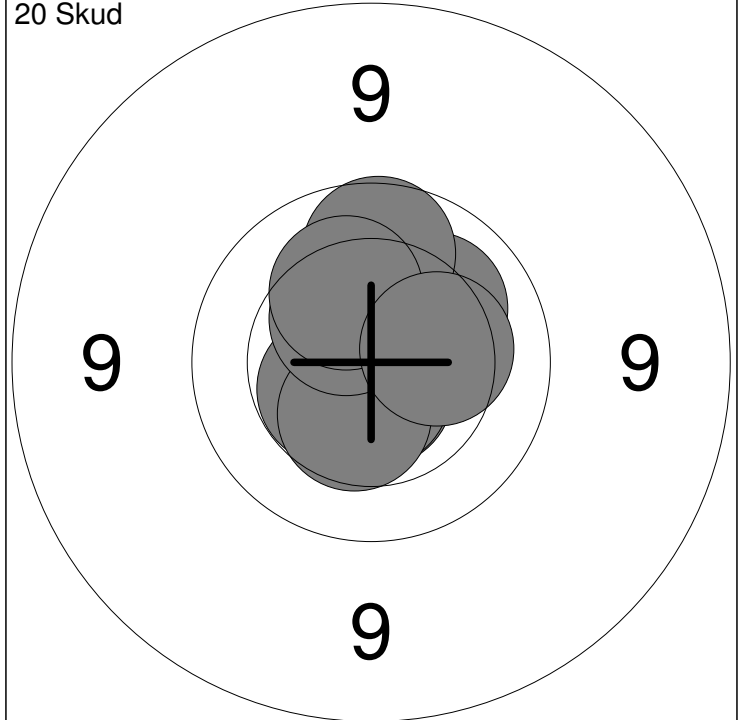
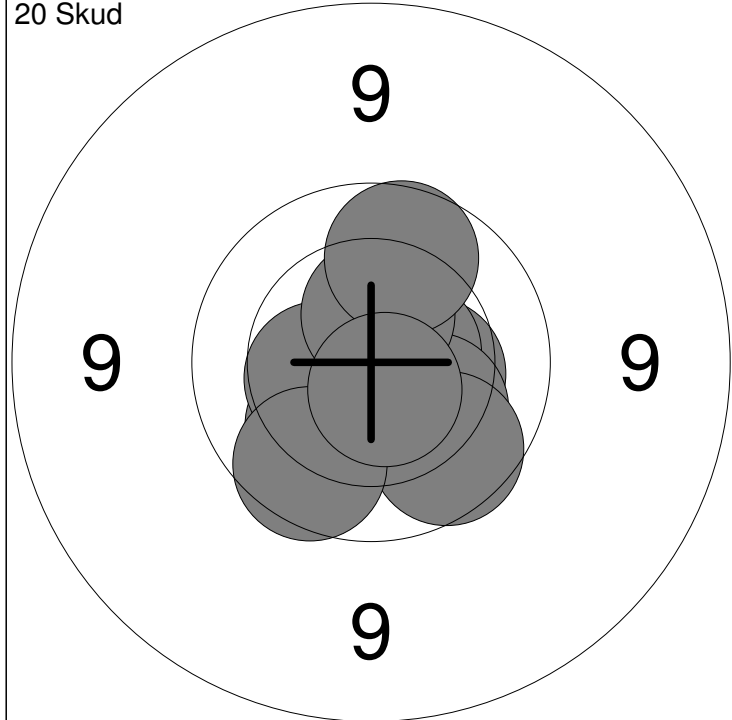

1: 10.2 ↙	6: 9.9 ↘	Serie 97 (2x)
2: 10.4 ←	7: 9.9 ↘	
3: 10.4 →	8: 10.5 ↑	Total 97 (2x)
4: 10.6x →	9: 9.9 ↑	
5: 10.2 ↘	10: 10.7x ↘	

11: 10.7x ↓	16: 10.4 ↓	Serie 99 (4x)
12: 10.7x ↓	17: 9.9 ↑	
13: 10.5x ↙	18: 10.5 ↗	Total 196 (6x)
14: 10.9x ↘	19: 10.2 ↑	
15: 10.2 ↗	20: 10.3 →	

Hold 21	Skive 7	Andreas_Myrup
-------------------	-------------------	----------------------

15 meter	Vilsted Skytteforening	BK1
----------	------------------------	-----

Nordjysk mesterskab 2019	Aalborg Skyttekreds
--------------------------	---------------------

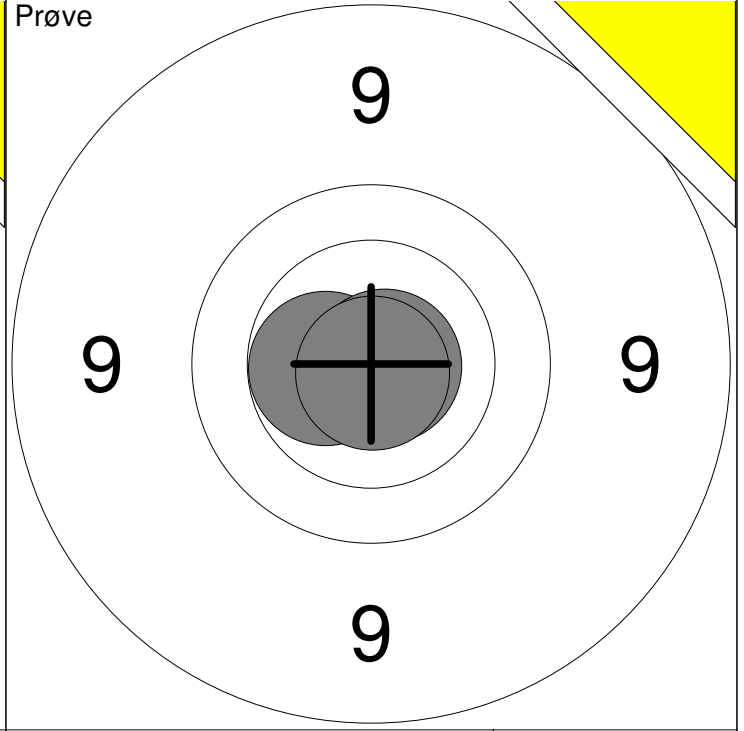
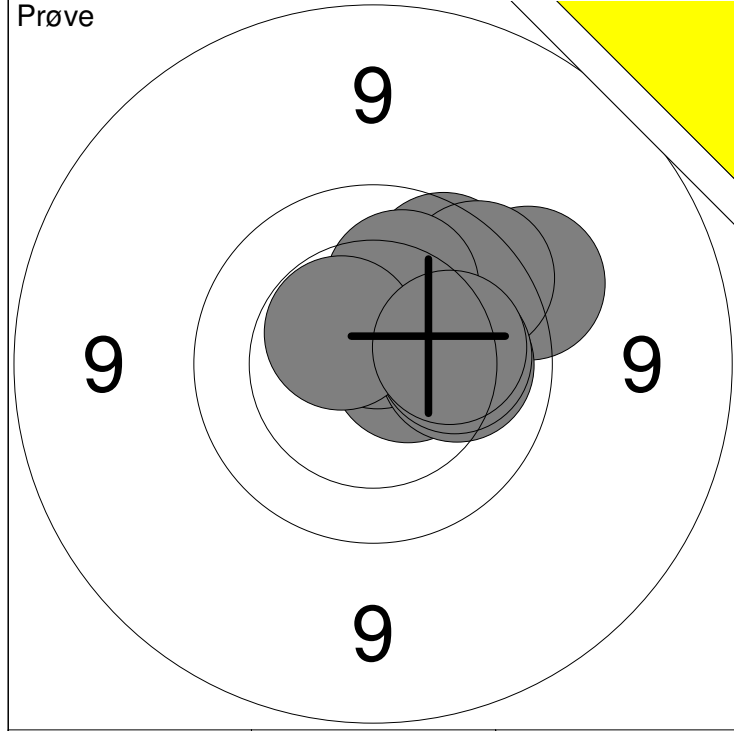

1: 10.6x →	6: 10.1 →	Serie	97 (3x)
2: 9.5 ↗	7: 10.1 →		
3: 9.9 ↗	8: 10.1 ↗	Total	0 (0x)
4: 9.8 ↗	9: 10.5x ↖		
5: 10.6x ↑	10: 10.2 →		

11: 10.5x ←	Serie	30 (3x)
12: 10.8x →		
13: 10.9x ↓	Total	0 (0x)

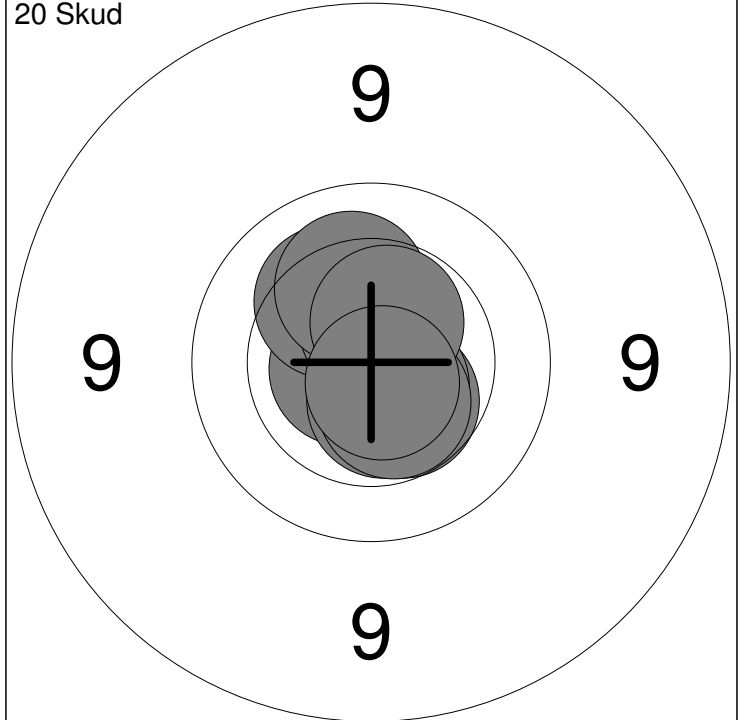
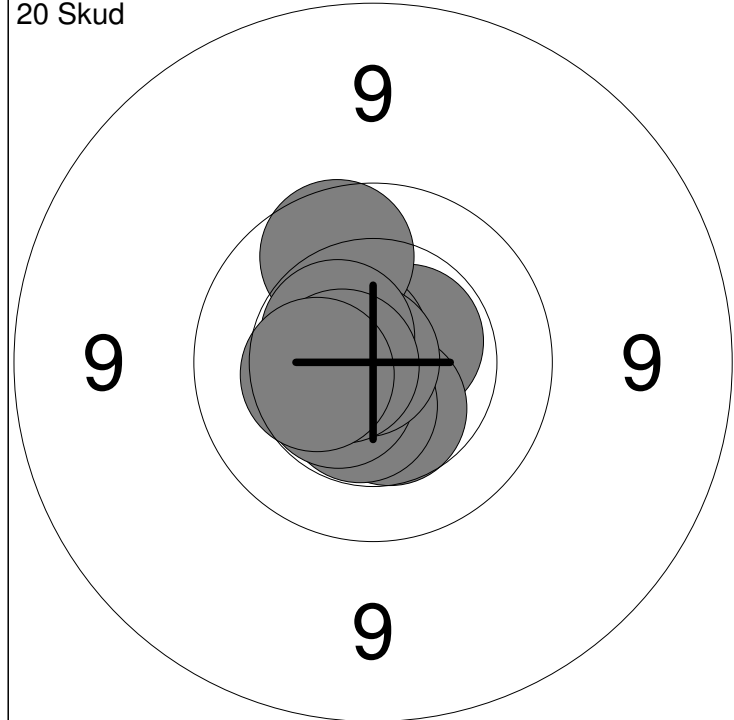

1: 10.6x ↗	6: 10.5x ←	Serie	99 (7x)
2: 10.5 ↓	7: 10.8x ←		
3: 10.5x ↓	8: 10.5x ↖	Total	99 (7x)
4: 10.7x ↖	9: 10.6x ←		
5: 9.9 ↑	10: 10.4 ←		

11: 10.7x ←	16: 10.6x ↑	Serie	100 (7x)
12: 10.2 ↗	17: 10.2 ↑		
13: 10.5 ↓	18: 10.5x ↓	Total	199 (14x)
14: 10.6x ↓	19: 10.5x ↗		
15: 10.5x ↓	20: 10.7x ↓		

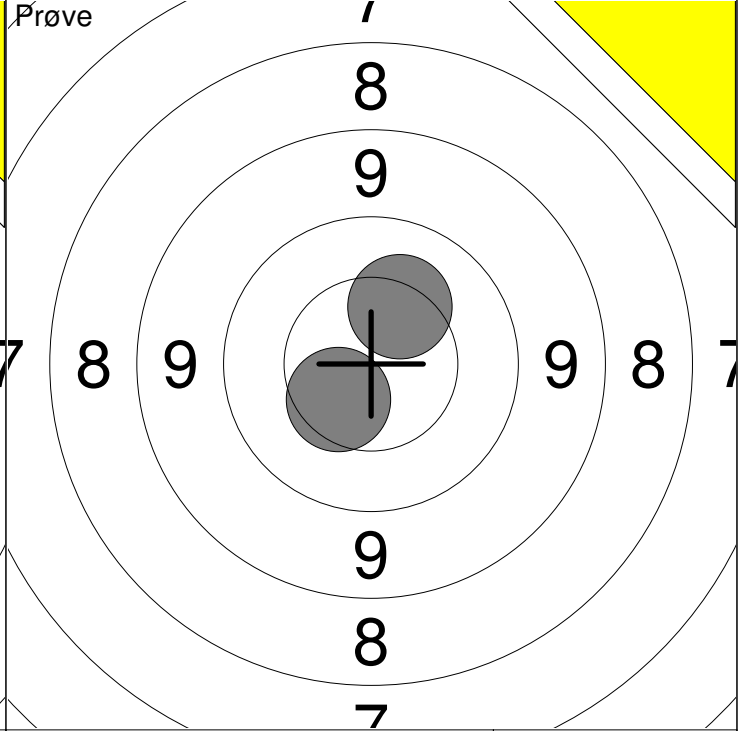
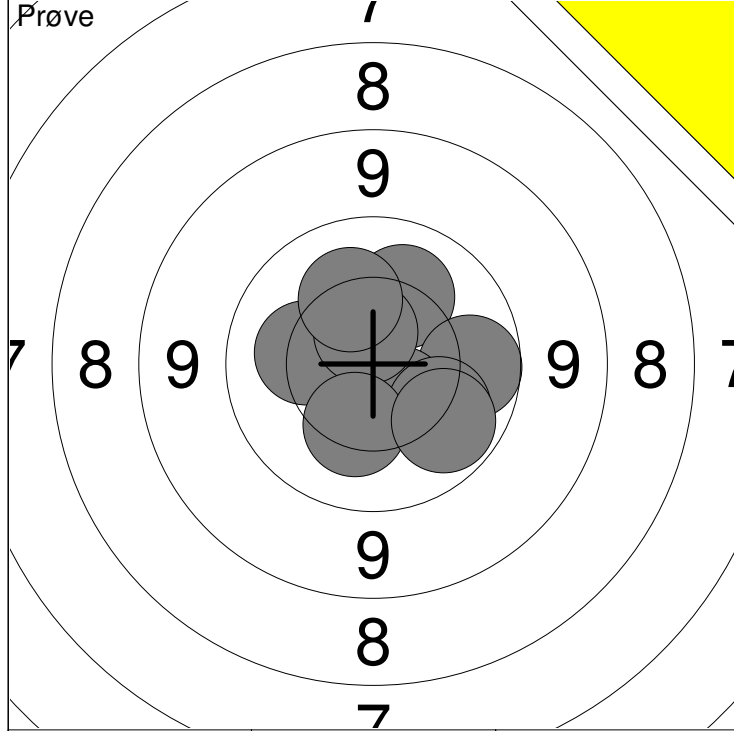

1: 10.6 ↗	6: 10.6x ↗	Serie 99 (1x)
2: 10.2 ←	7: 10.1 ↘	
3: 10.2 ↗	8: 10.2 ↗	Total 0 (0x)
4: 9.9 →	9: 10.3 ↓	
5: 10.5 ↘	10: 10.0 ↘	

11: 10.3 ↗	Serie 20 (0x)
12: 10.4 ↘	
Total 0 (0x)	

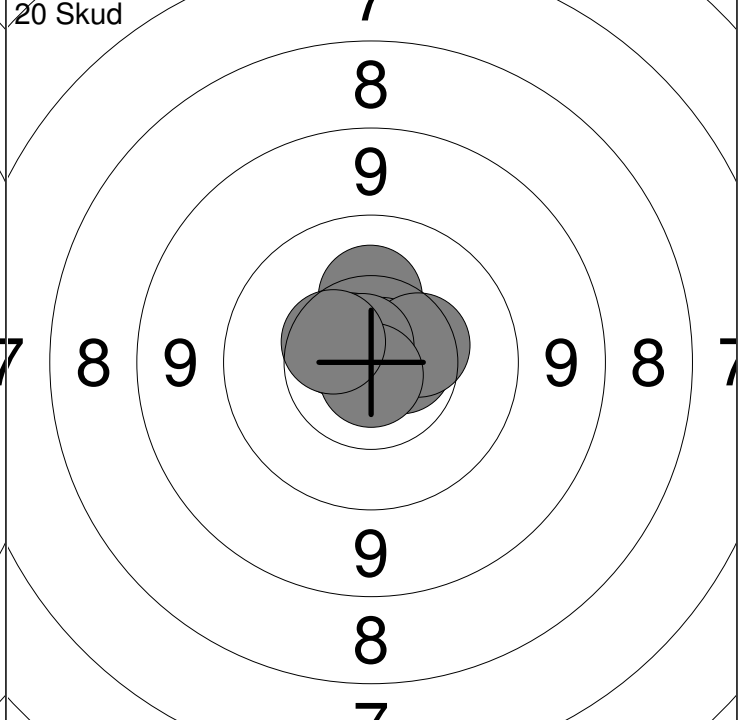
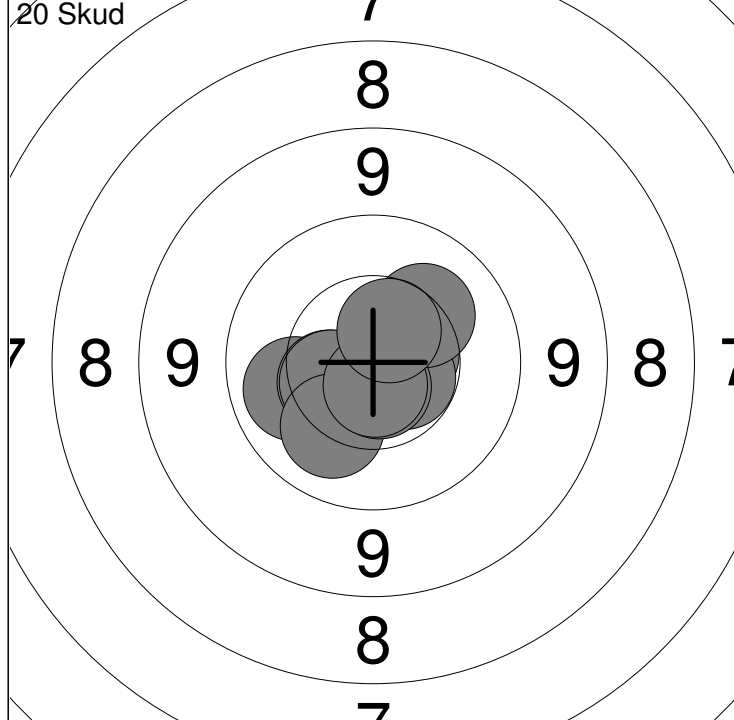

1: 10.1 ←	6: 10.6x →	Serie 100 (3x)
2: 10.4 ←	7: 10.2 ↗	
3: 10.5 ←	8: 10.7x ↓	Total 100 (3x)
4: 10.2 ↘	9: 10.7x ↓	
5: 10.6 →	10: 10.6 ↗	

11: 10.6x →	16: 10.8x ↗	Serie 100 (7x)
12: 10.6x ←	17: 10.4 →	
13: 10.7x ↗	18: 10.8x ↗	Total 200 (10x)
14: 10.3 ↗	19: 10.8x ↓	
15: 10.7x ←	20: 10.5 ←	

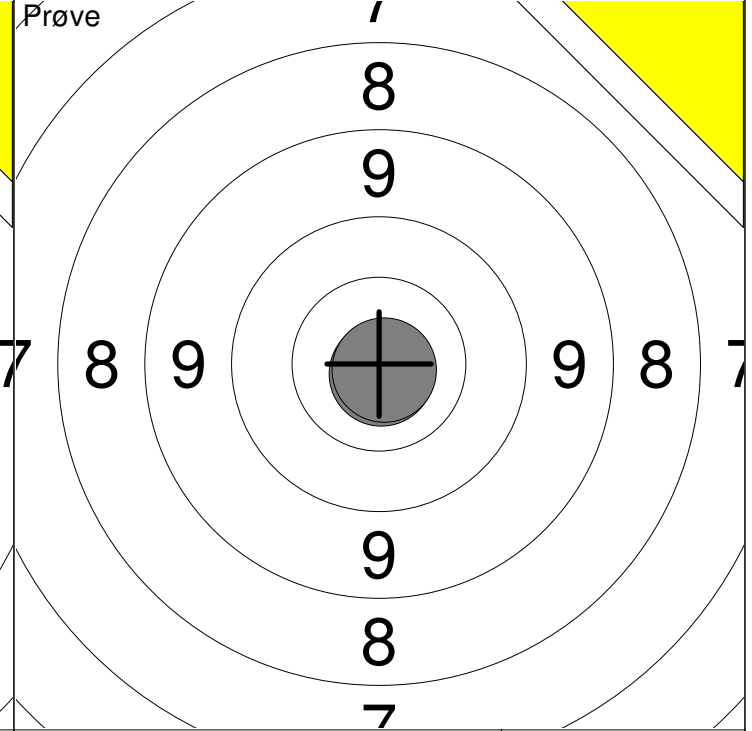
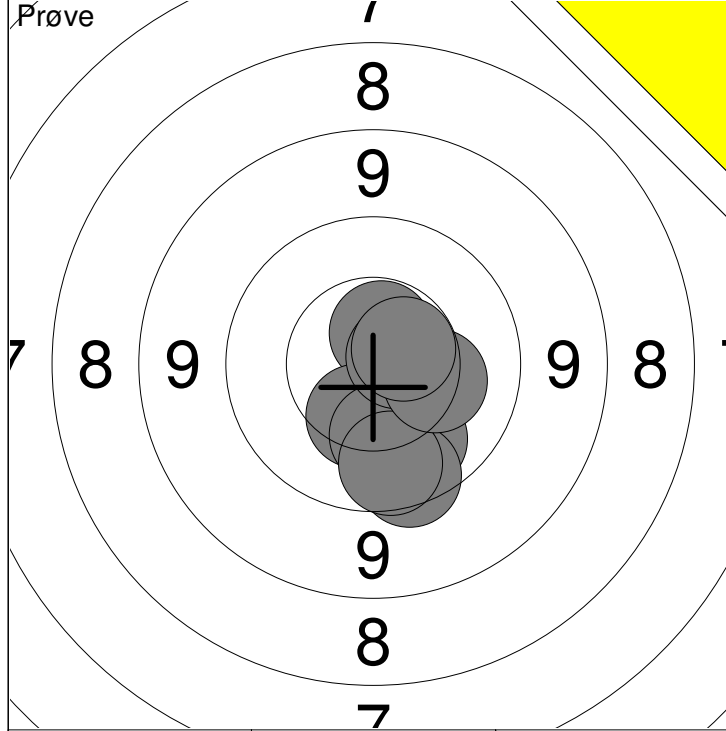

1: 10.6x ↗	6: 10.2 ↓	Serie 98 (3x)
2: 10.3 ↓	7: 9.9 ↓	
3: 10.1 ↓	8: 10.7x →	Total 0 (0x)
4: 9.7 ↓	9: 10.3 →	
5: 10.4 ↓	10: 10.6x ↗	

11: 10.8x ↓	Serie 20 (2x)
12: 10.9x ↘	
	Total 0 (0x)

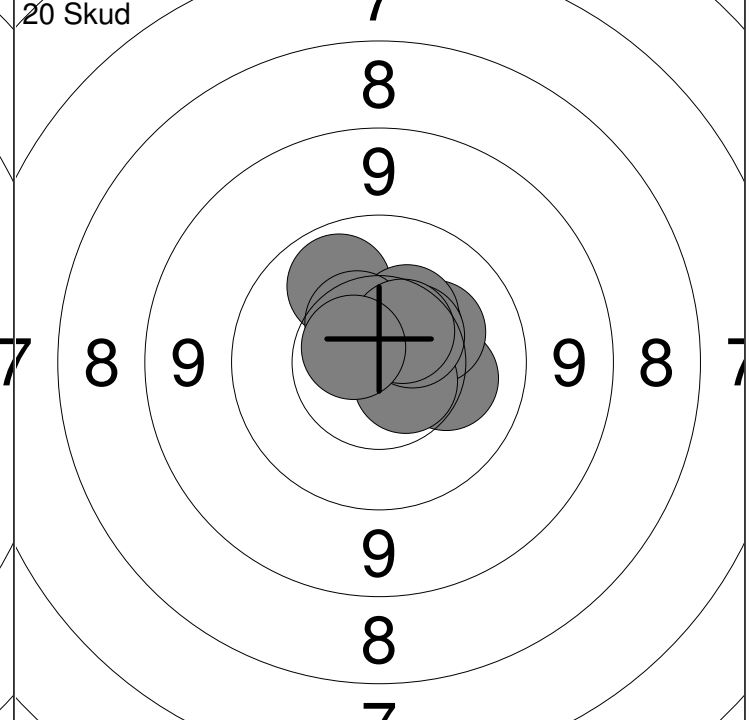
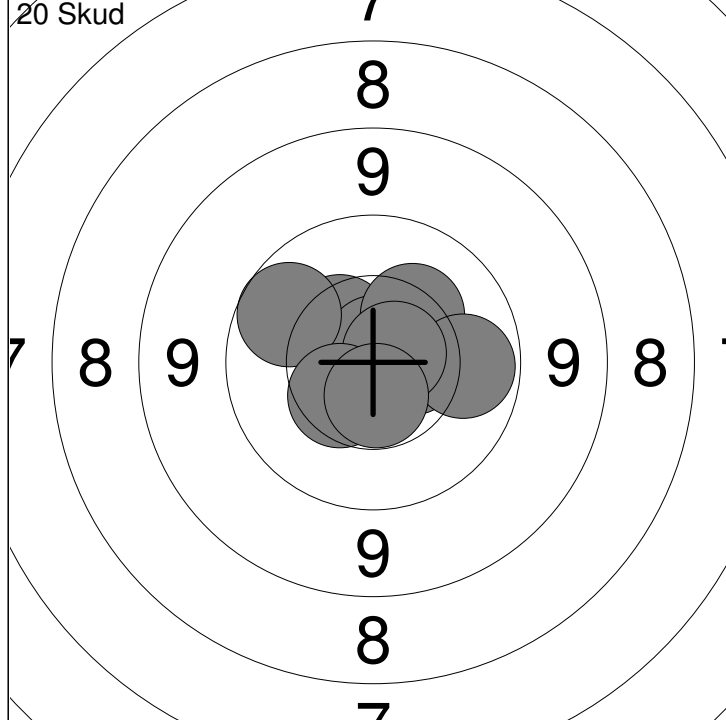

1: 10.6 →	6: 10.3 ↗	Serie 99 (4x)
2: 10.4 ↗	7: 10.0 →	
3: 10.8x ←	8: 10.7x →	Total 99 (4x)
4: 10.8x ↑	9: 10.5 ↘	
5: 9.9 ↖	10: 10.6x ↓	

11: 10.2 →	16: 10.4 ↗	Serie 100 (2x)
12: 10.3 ↗	17: 10.5 ↗	
13: 10.5 ↗	18: 10.5 ↖	Total 199 (6x)
14: 10.6x ↘	19: 10.5 ↗	
15: 10.0 ↖	20: 10.6x ↖	

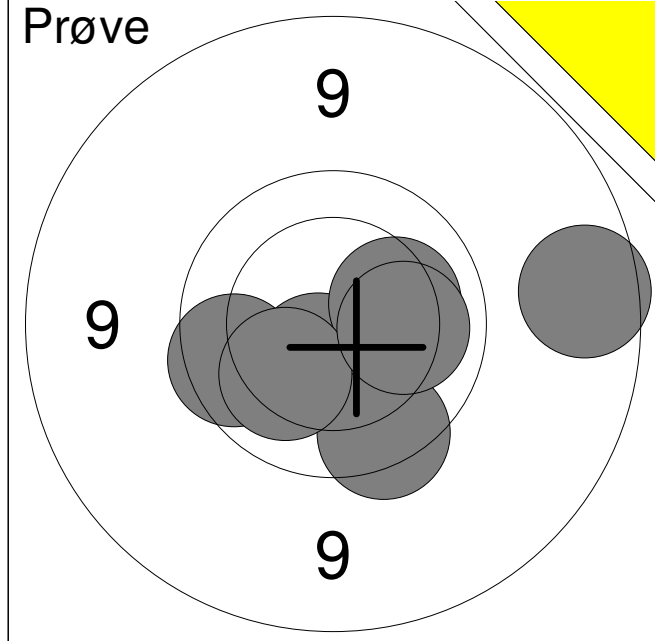

1:	9.8	←
2:	8.9	→
3:	10.5x	↓
4:	10.2	→
5:	9.7	↓
6:	10.2	↓
7:	10.1	→
Serie		66 (1x)
Total		0 (0x)

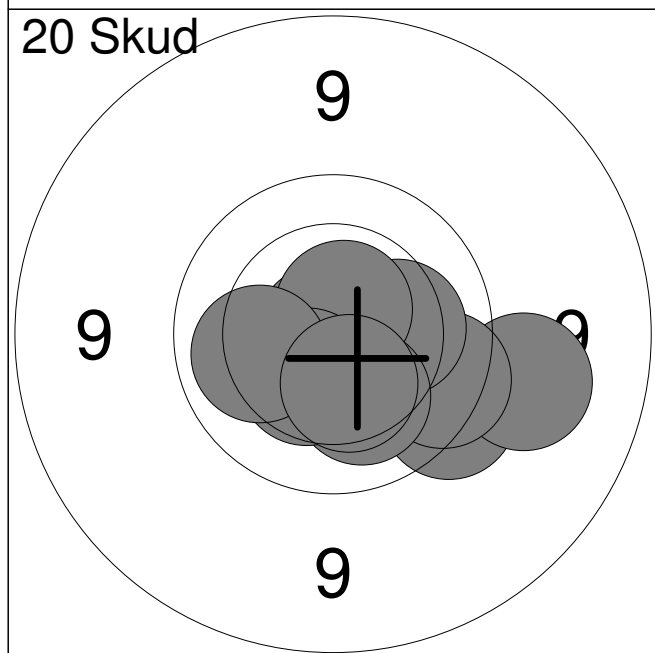

1:	9.6	↘
2:	9.3	→
3:	9.8	↘
4:	10.2	→
5:	10.2	↓
6:	10.9x	←
7:	10.7x	↗
8:	10.4	↓
9:	10.1	←
10:	10.4	↓
Serie		97 (2x)
Total		97 (2x)

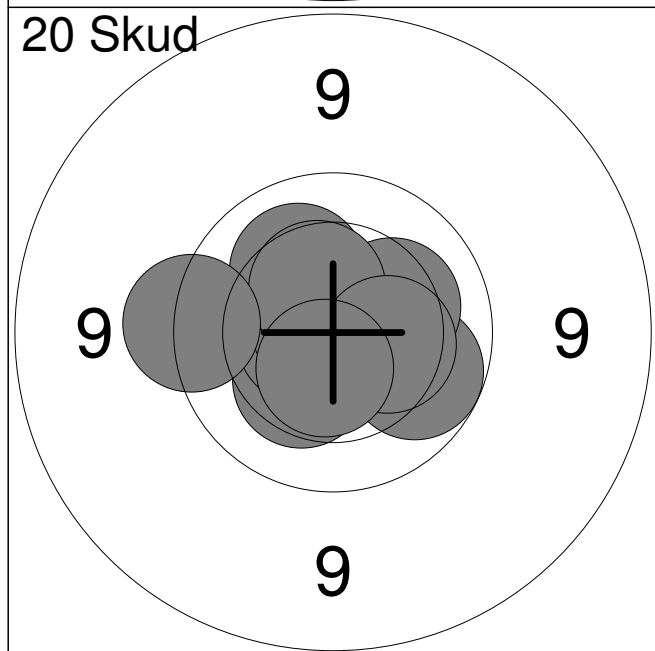

11:	10.0	↘
12:	10.3	↓
13:	10.6x	←
14:	10.8x	↗
15:	10.2	↗
16:	10.2	→
17:	10.4	↗
18:	10.3	→
19:	9.6	←
20:	10.5x	↓
Serie		99 (3x)
Total		196 (5x)

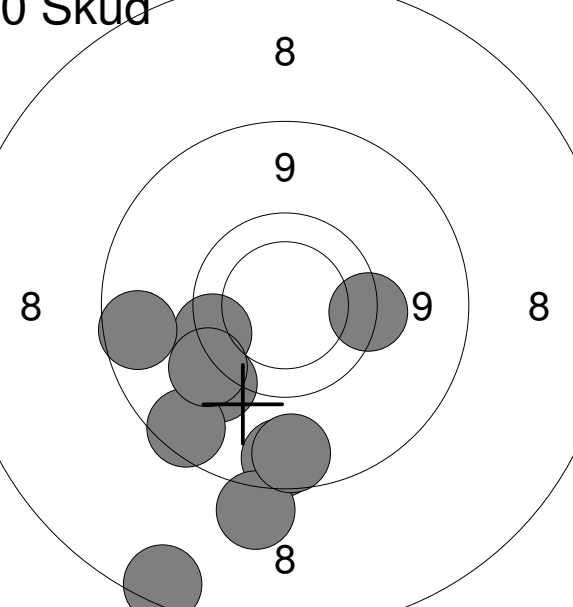
Hold 21	Skive 11	Steffen Wulff Soerensen		
15 meter		Hjallerup Skytteforening		BK4
		Nordjysk mesterskab 2019	Aalborg Skyttekreds	
Prøve 		1: 9.2 ↘ 2: 9.0 ↙ 3: 8.7 ↓ 4: 9.2 ↙ 5: 8.8 ↓ 6: 9.4 ↙ 7: 9.9 ↙ 8: 9.6 ↘		
		Serie		70 (0x)
		Total		0 (0x)
20 Skud 		1: 8.9 ↓ 2: 9.6 → 3: 9.7 ↙ 4: 9.4 ↙ 5: 8.9 ↙ 6: 8.5 ↓ 7: 7.8 ↓ 8: 8.9 ↓ 9: 8.9 ↙ 10: 9.4 ↙		
		Serie		83 (0x)
		Total		83 (0x)
20 Skud 		11: 9.5 ↙ 12: 9.6 ↓ 13: 9.6 ↘ 14: 9.7 ↑ 15: 10.5x ↙ 16: 9.8 ↘ 17: 9.9 ↙ 18: 10.3 ↙ 19: 9.3 ↓ 20: 9.0 ↘		
		Serie		92 (1x)
		Total		175 (1x)

	Nordjysk mesterskab 2019	Aalborg Skyttekreds																																		
Prøve 	<table style="width:100%; border-collapse: collapse;"> <tr><td style="width:5%;">1:</td><td style="width:15%;">9.3</td><td style="width:10%; text-align: right;">←</td></tr> <tr><td>2:</td><td>9.9</td><td style="text-align: right;">↓</td></tr> <tr><td>3:</td><td>9.8</td><td style="text-align: right;">←</td></tr> <tr><td>4:</td><td>10.5x</td><td style="text-align: right;">↓</td></tr> <tr><td>5:</td><td>9.9</td><td style="text-align: right;">→</td></tr> <tr><td>6:</td><td>9.7</td><td style="text-align: right;">↓</td></tr> <tr><td>7:</td><td>10.7x</td><td style="text-align: right;">↓</td></tr> <tr><td>8:</td><td>10.2</td><td style="text-align: right;">←</td></tr> <tr><td>9:</td><td>9.7</td><td style="text-align: right;">←</td></tr> <tr><td>10:</td><td>10.6x</td><td style="text-align: right;">↗</td></tr> </table>	1:	9.3	←	2:	9.9	↓	3:	9.8	←	4:	10.5x	↓	5:	9.9	→	6:	9.7	↓	7:	10.7x	↓	8:	10.2	←	9:	9.7	←	10:	10.6x	↗	<table style="width:100%; border-collapse: collapse;"> <tr> <td style="width:80%;">Serie</td> <td style="text-align: right;">94 (3x)</td> </tr> <tr> <td>Total</td> <td style="text-align: right;">0 (0x)</td> </tr> </table>	Serie	94 (3x)	Total	0 (0x)
1:	9.3	←																																		
2:	9.9	↓																																		
3:	9.8	←																																		
4:	10.5x	↓																																		
5:	9.9	→																																		
6:	9.7	↓																																		
7:	10.7x	↓																																		
8:	10.2	←																																		
9:	9.7	←																																		
10:	10.6x	↗																																		
Serie	94 (3x)																																			
Total	0 (0x)																																			

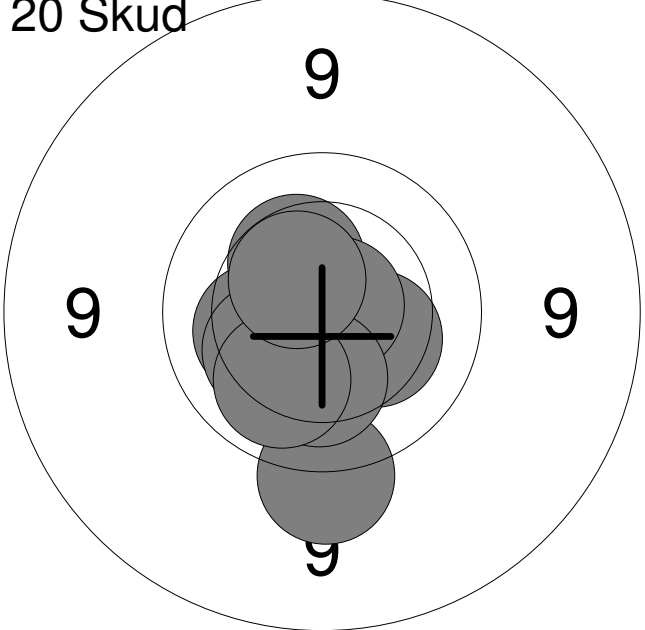
20 Skud 	<table style="width:100%; border-collapse: collapse;"> <tr><td style="width:5%;">1:</td><td style="width:15%;">10.9x</td><td style="width:10%; text-align: right;">→</td></tr> <tr><td>2:</td><td>10.2</td><td style="text-align: right;">←</td></tr> <tr><td>3:</td><td>10.3</td><td style="text-align: right;">↘</td></tr> <tr><td>4:</td><td>9.5</td><td style="text-align: right;">↓</td></tr> <tr><td>5:</td><td>10.2</td><td style="text-align: right;">←</td></tr> <tr><td>6:</td><td>10.3</td><td style="text-align: right;">↑</td></tr> <tr><td>7:</td><td>10.8x</td><td style="text-align: right;">↗</td></tr> <tr><td>8:</td><td>10.2</td><td style="text-align: right;">↓</td></tr> <tr><td>9:</td><td>10.1</td><td style="text-align: right;">↓</td></tr> <tr><td>10:</td><td>10.5x</td><td style="text-align: right;">↗</td></tr> </table>	1:	10.9x	→	2:	10.2	←	3:	10.3	↘	4:	9.5	↓	5:	10.2	←	6:	10.3	↑	7:	10.8x	↗	8:	10.2	↓	9:	10.1	↓	10:	10.5x	↗	<table style="width:100%; border-collapse: collapse;"> <tr> <td style="width:80%;">Serie</td> <td style="text-align: right;">99 (3x)</td> </tr> <tr> <td>Total</td> <td style="text-align: right;">99 (3x)</td> </tr> </table>	Serie	99 (3x)	Total	99 (3x)
1:	10.9x	→																																		
2:	10.2	←																																		
3:	10.3	↘																																		
4:	9.5	↓																																		
5:	10.2	←																																		
6:	10.3	↑																																		
7:	10.8x	↗																																		
8:	10.2	↓																																		
9:	10.1	↓																																		
10:	10.5x	↗																																		
Serie	99 (3x)																																			
Total	99 (3x)																																			

20 Skud 	<table style="width:100%; border-collapse: collapse;"> <tr><td style="width:5%;">11:</td><td style="width:15%;">10.1</td><td style="width:10%; text-align: right;">↗</td></tr> <tr><td>12:</td><td>10.8x</td><td style="text-align: right;">↑</td></tr> <tr><td>13:</td><td>10.3</td><td style="text-align: right;">↓</td></tr> <tr><td>14:</td><td>9.8</td><td style="text-align: right;">↗</td></tr> <tr><td>15:</td><td>8.9</td><td style="text-align: right;">←</td></tr> <tr><td>16:</td><td>9.9</td><td style="text-align: right;">↗</td></tr> <tr><td>17:</td><td>9.8</td><td style="text-align: right;">←</td></tr> <tr><td>18:</td><td>10.5</td><td style="text-align: right;">↗</td></tr> <tr><td>19:</td><td>10.2</td><td style="text-align: right;">←</td></tr> <tr><td>20:</td><td>9.8</td><td style="text-align: right;">↑</td></tr> </table>	11:	10.1	↗	12:	10.8x	↑	13:	10.3	↓	14:	9.8	↗	15:	8.9	←	16:	9.9	↗	17:	9.8	←	18:	10.5	↗	19:	10.2	←	20:	9.8	↑	<table style="width:100%; border-collapse: collapse;"> <tr> <td style="width:80%;">Serie</td> <td style="text-align: right;">94 (1x)</td> </tr> <tr> <td>Total</td> <td style="text-align: right;">193 (4x)</td> </tr> </table>	Serie	94 (1x)	Total	193 (4x)
11:	10.1	↗																																		
12:	10.8x	↑																																		
13:	10.3	↓																																		
14:	9.8	↗																																		
15:	8.9	←																																		
16:	9.9	↗																																		
17:	9.8	←																																		
18:	10.5	↗																																		
19:	10.2	←																																		
20:	9.8	↑																																		
Serie	94 (1x)																																			
Total	193 (4x)																																			

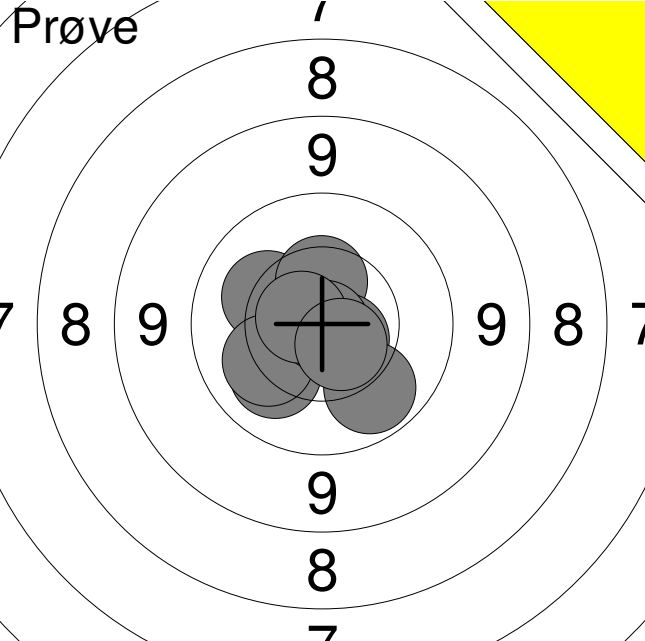
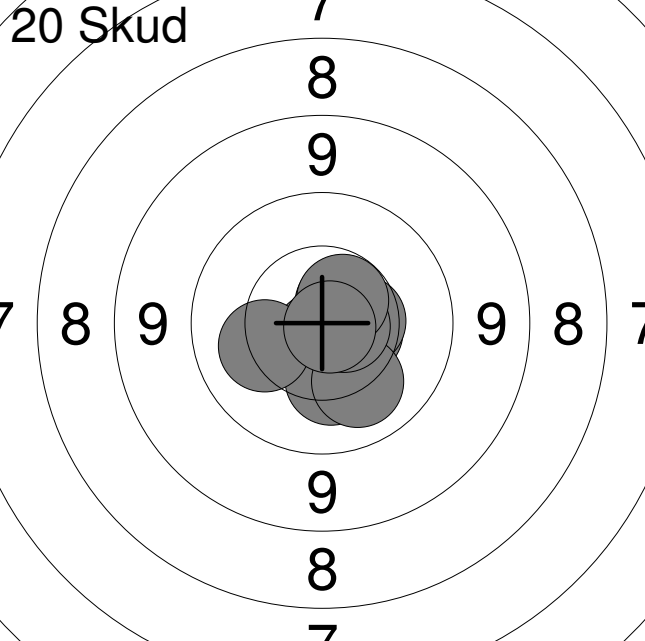
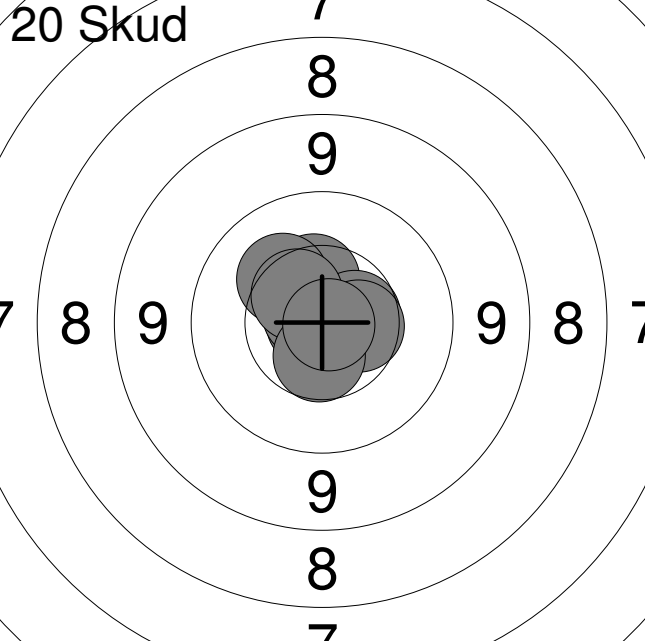
Hold 22	Skive 1	Trine Weinreich Klit Andersen	
15 meter		Vester Hassing Skytteforening	J1
		Nordjysk mesterskab 2019	Aalborg Skyttekreds
Prøve 	1:	10.2	↖
	2:	10.8x	↓
	3:	10.4	↑
	4:	10.2	↙
	5:	10.2	↙
	6:	10.6x	↘
	7:	10.0	↘
	8:	10.9x	↘
	9:	10.7x	↖
	10:	10.6x	↓
	Serie		100 (5x)
Total		0 (0x)	
20 Skud 	1:	10.6x	↗
	2:	10.8x	↓
	3:	10.3	↓
	4:	10.5	→
	5:	10.5	→
	6:	10.2	↙
	7:	10.1	↘
	8:	10.7x	→
	9:	10.6x	↗
	10:	10.8x	↘
	Serie		100 (5x)
Total		100 (5x)	
20 Skud 	11:	10.4	↑
	12:	10.3	↗
	13:	10.6	→
	14:	10.8x	↙
	15:	10.8x	↗
	16:	10.6	→
	17:	10.5	→
	18:	10.5	↗
	19:	10.6	↓
	20:	10.9x	↘
	Serie		100 (3x)
Total		200 (8x)	

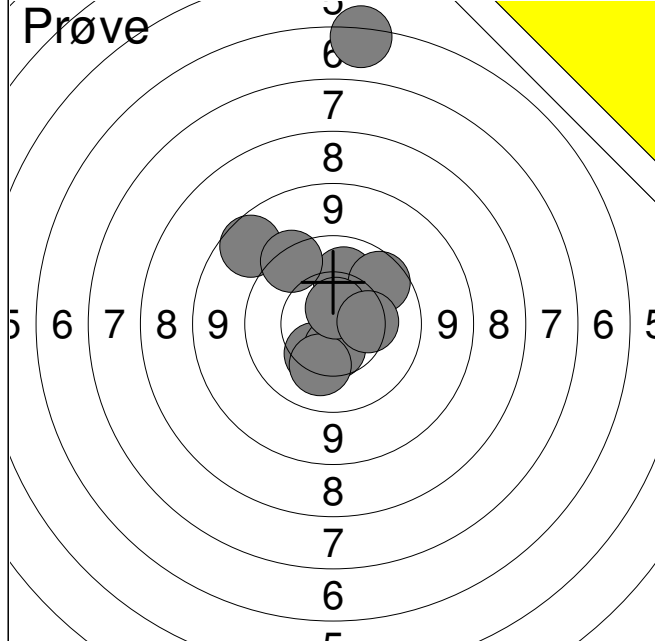

1:	5.5	↑
2:	10.1	↑
3:	8.9	↖
4:	9.6	↖
5:	9.9	↗
6:	10.3	↘
7:	10.5	↓
8:	10.2	↘
9:	10.7x	↑
10:	10.3	→
Serie		91 (1x)
Total		0 (0x)

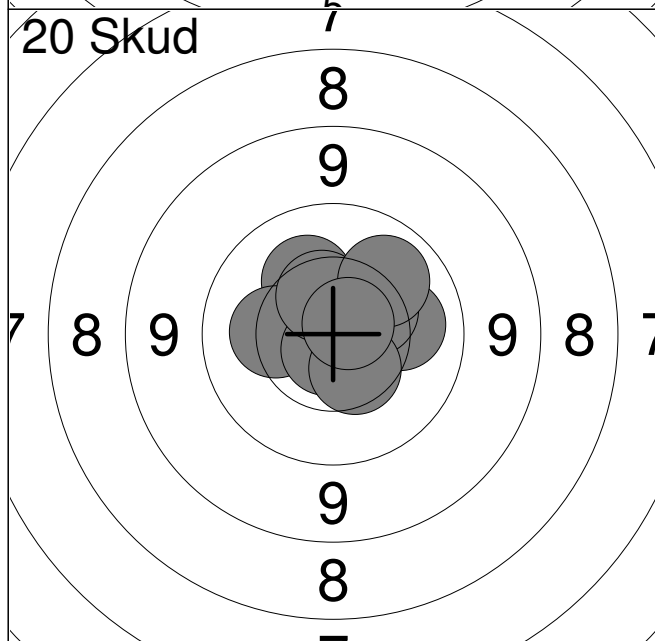

1:	10.8x	↗
2:	10.3	↖
3:	10.3	←
4:	10.2	→
5:	10.8x	↘
6:	10.5	↑
7:	10.4	↗
8:	10.1	↗
9:	10.5	↘
10:	10.7x	↗
Serie		100 (3x)
Total		100 (3x)

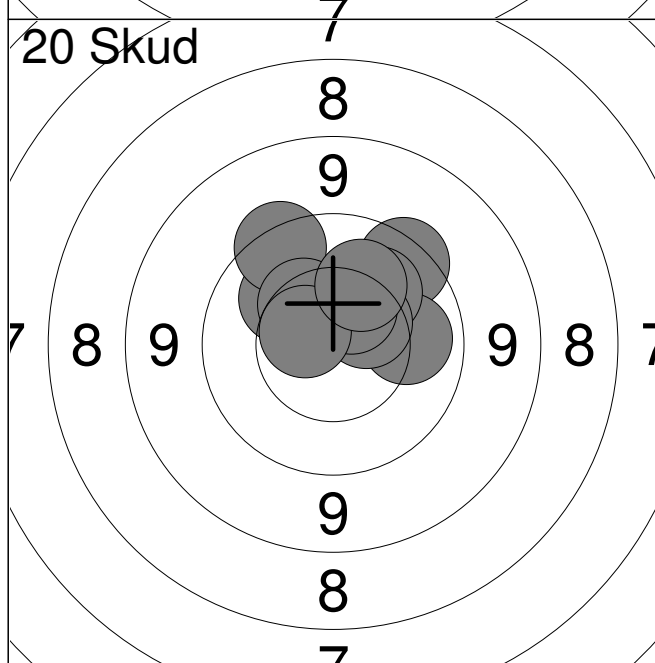

11:	10.2	↖
12:	9.7	↗
13:	10.1	→
14:	10.2	↗
15:	10.5	↗
16:	9.6	↖
17:	10.5	↗
18:	10.4	↖
19:	10.6	↖
20:	10.2	↑
Serie		98 (0x)
Total		198 (3x)

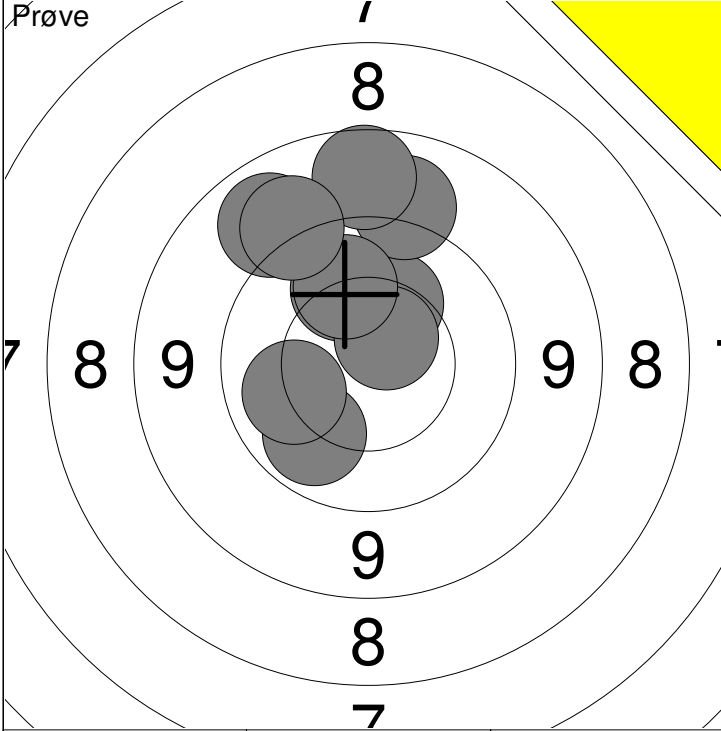

1: 10.3 ↗	6: 10.0 ↘
2: 10.1 ↗	7: 10.1 ←
3: 9.1 ↖	8: 8.9 ↑
4: 9.2 ↗	9: 10.1 ↗
5: 10.6x ↗	10: 9.3 ↖

Serie	95 (1x)
Total	0 (0x)

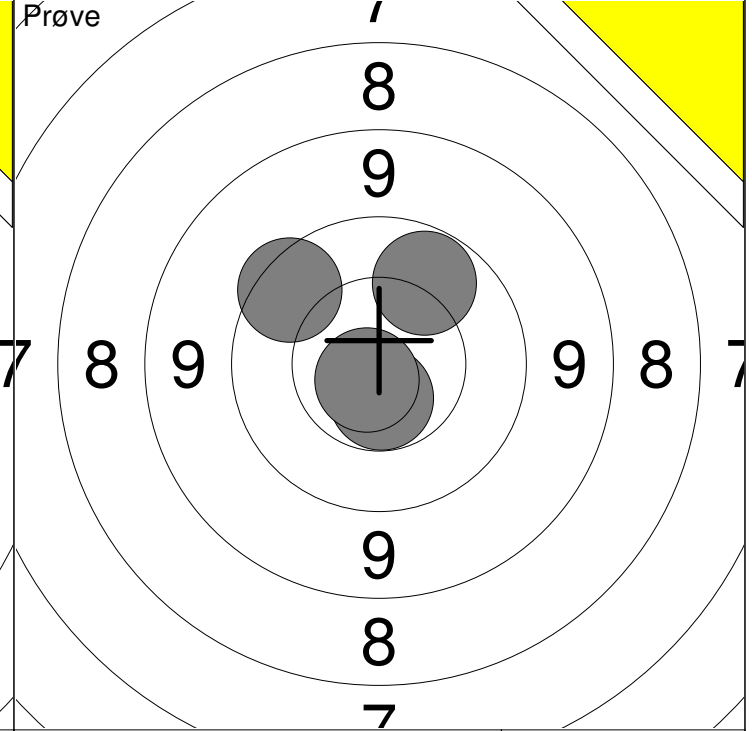

11: 10.6x ↓	12: 9.7 ↖
13: 10.0 ↗	14: 10.7x ↘

Serie	39 (2x)
Total	0 (0x)

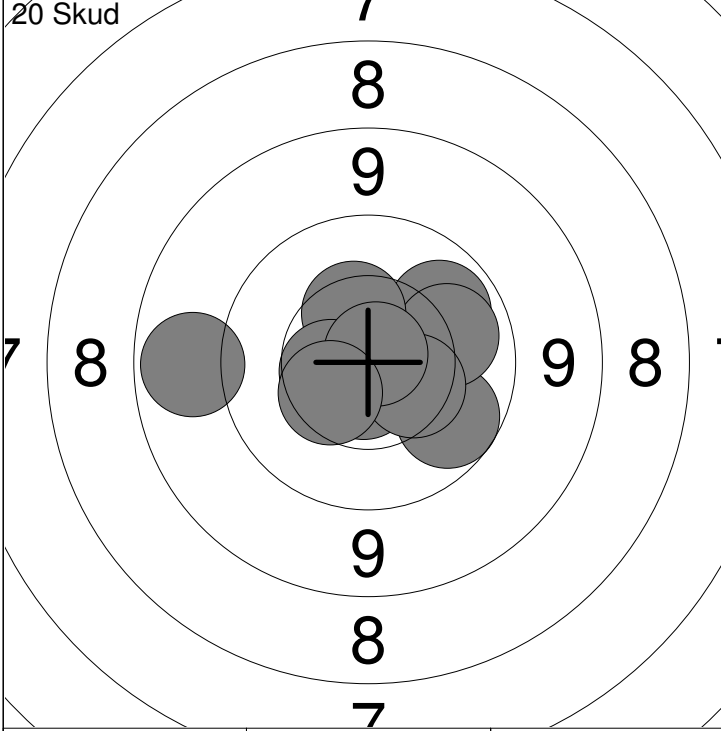

1: 10.0 ↗	6: 10.4 ↑
2: 10.7x ↓	7: 10.5 ←
3: 9.9 ↘	8: 10.4 ↘
4: 10.1 ↗	9: 10.8x ↗
5: 9.0 ←	10: 10.4 ↘

Serie	98 (2x)
Total	98 (2x)

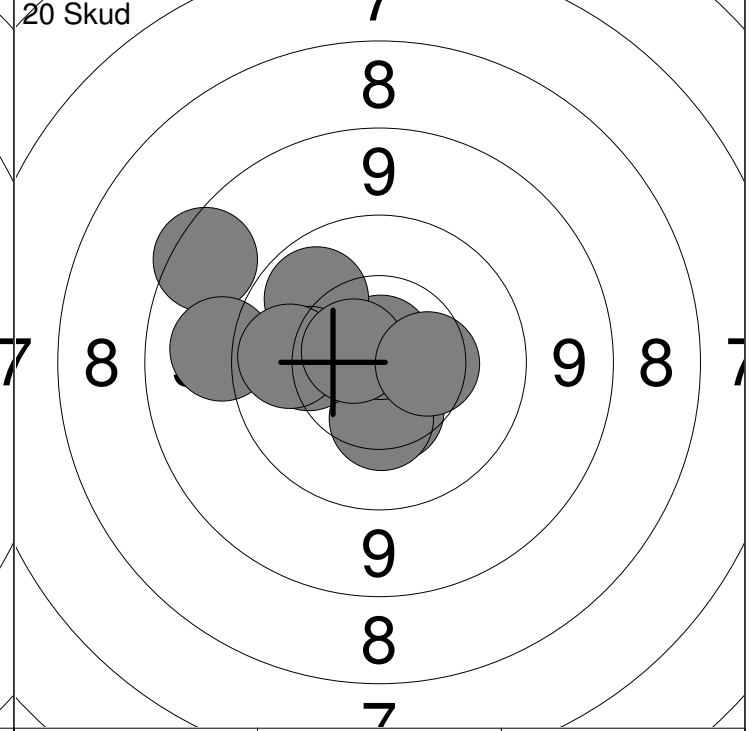

11: 10.4 ↓	16: 9.2 ←
12: 10.4 ↓	17: 10.2 ←
13: 8.7 ↖	18: 10.0 ←
14: 10.8x ↑	19: 10.7x ↖
15: 10.0 ↖	20: 10.4 →

Serie	97 (2x)
Total	195 (4x)

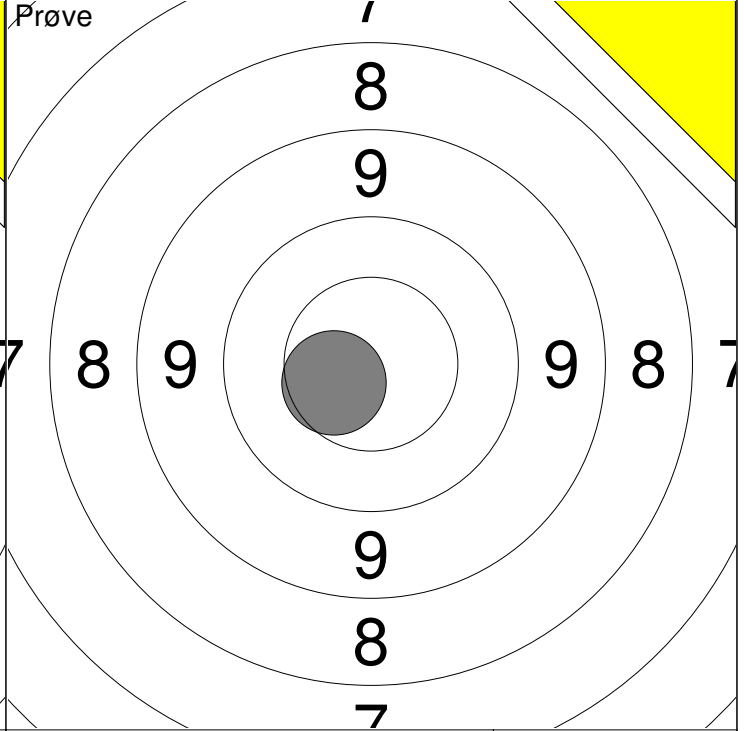
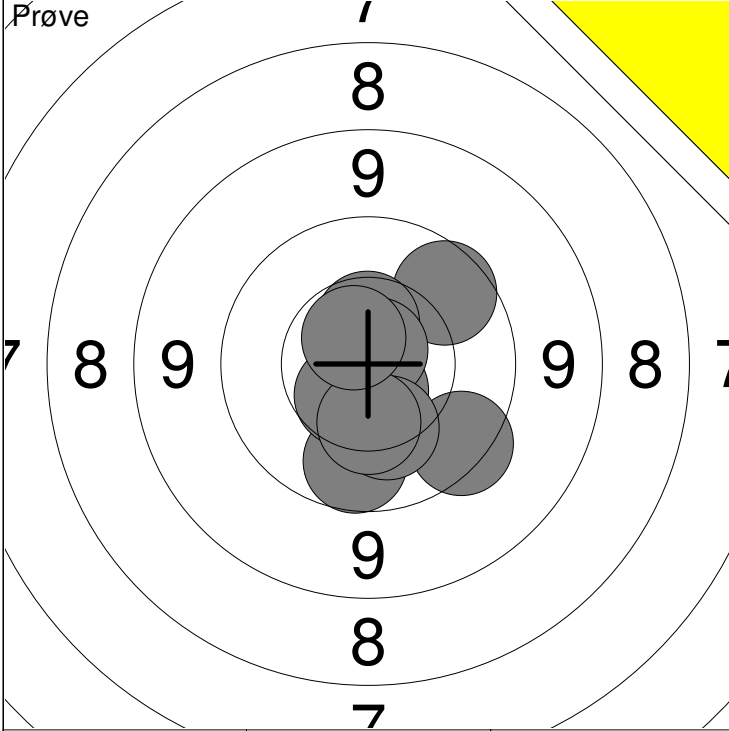

1: 9.6 ↘	6: 10.5 ↑	Serie 97 (3x)
2: 10.7x ↓	7: 10.8x ↗	
3: 9.8 ↗	8: 10.3 ↓	Total 0 (0x)
4: 9.9 ↓	9: 10.3 ↓	
5: 10.6 ↙	10: 10.6x ↗	

11: 10.5 ↙	Serie 10 (0x)
	Total 0 (0x)

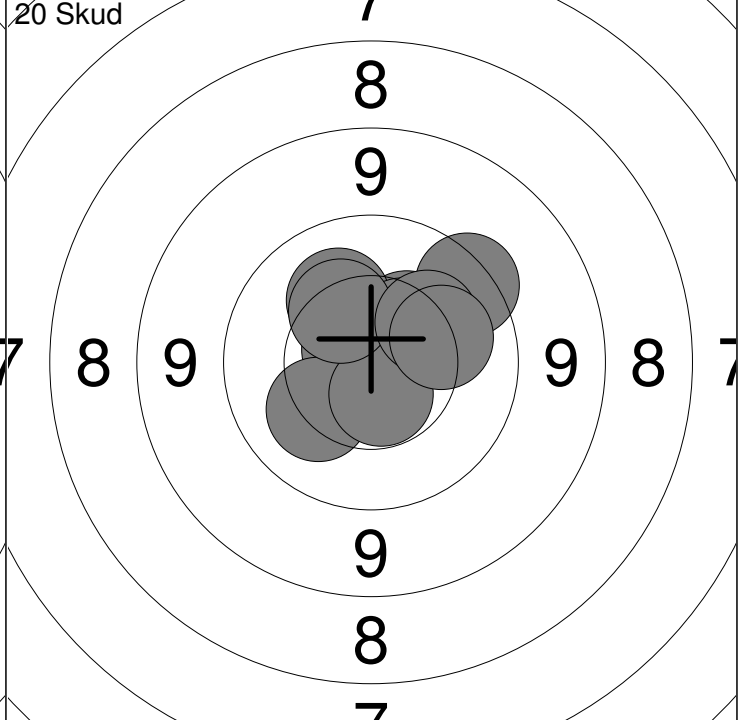
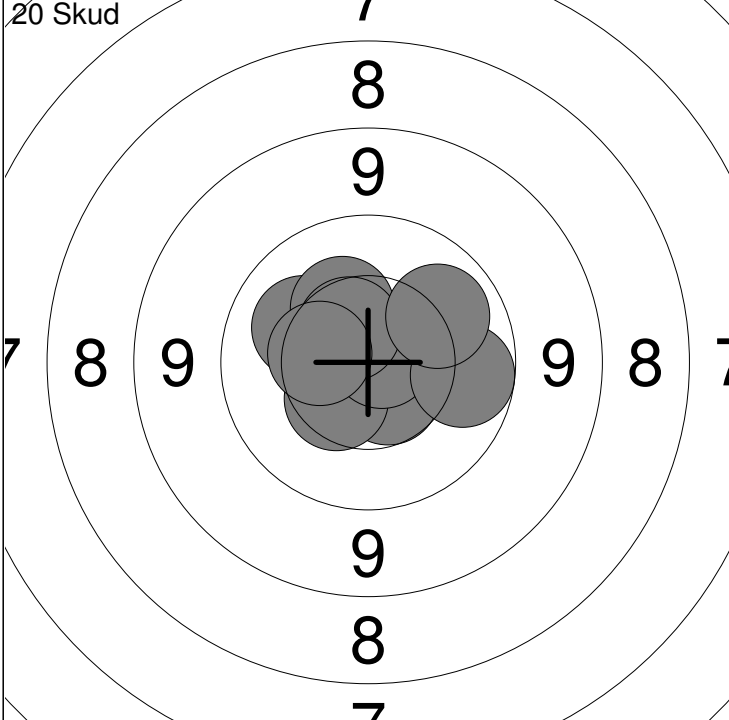

1: 10.4 ↗	6: 10.8x ↗	Serie 100 (1x)
2: 10.6 ↓	7: 10.5 ↗	
3: 10.2 ↗	8: 10.4 ←	Total 100 (1x)
4: 10.3 ↗	9: 10.0 →	
5: 10.4 ↙	10: 10.1 ↗	

11: 10.7x ↙	16: 10.5 ↗	Serie 99 (2x)
12: 10.4 ↗	17: 10.6x ↓	
13: 10.2 ↗	18: 10.3 ↗	Total 199 (3x)
14: 9.6 ↗	19: 10.2 ↗	
15: 10.2 ↙	20: 10.2 →	

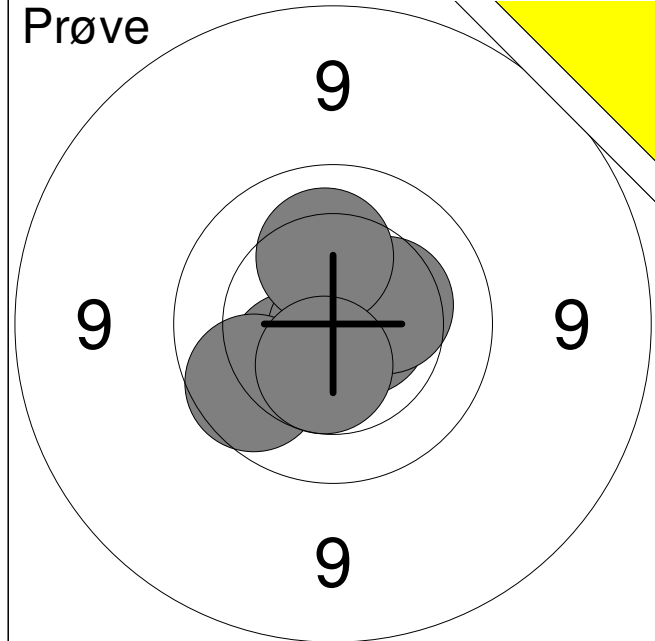

1:	10.4	↙
2:	10.9x	↓
3:	10.6x	→
4:	10.3	↗
5:	9.9	↙
6:	10.2	↑
7:	10.5	↓
Serie		69 (2x)
Total		0 (0x)

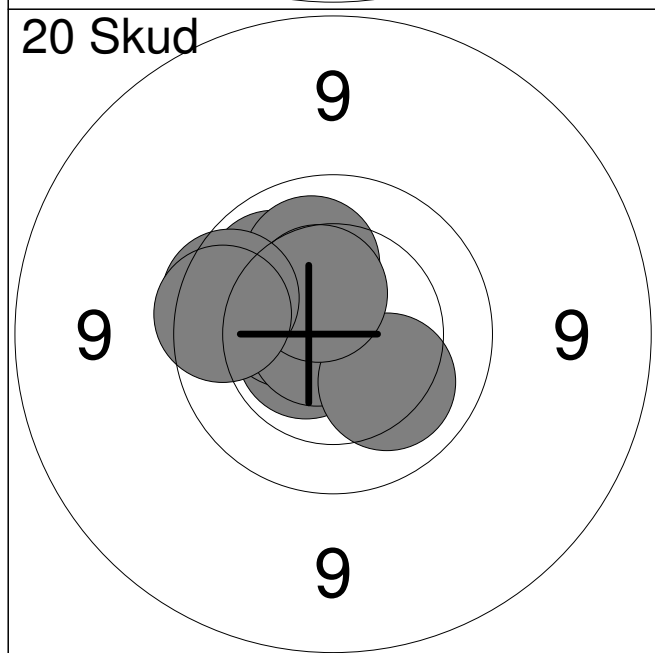

1:	10.6x	↙
2:	10.4	↙
3:	10.2	↗
4:	10.1	↗
5:	10.8x	↙
6:	10.2	↓
7:	10.1	↗
8:	10.5	↗
9:	9.8	↙
10:	9.8	↙
Serie		98 (2x)
Total		98 (2x)

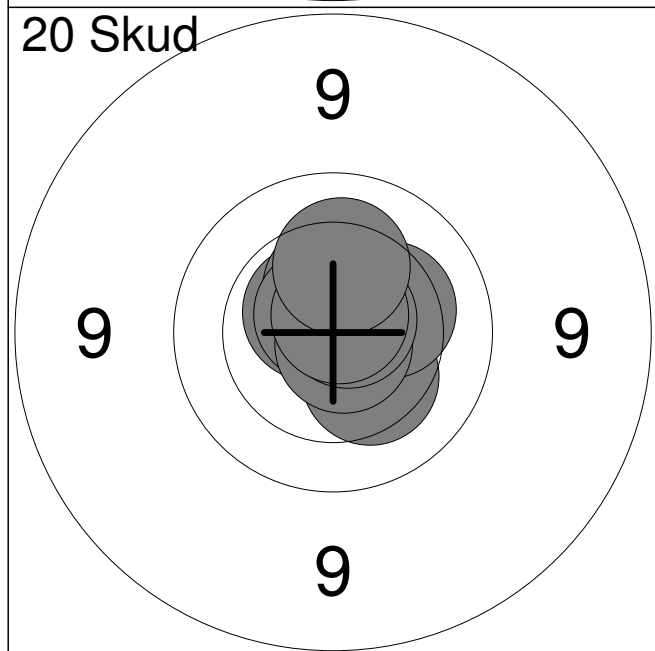

11:	10.6x	↗
12:	10.3	↓
13:	10.3	↗
14:	10.8x	↑
15:	10.5	↑
16:	10.7x	↗
17:	10.8x	↓
18:	10.7x	↗
19:	10.7x	↗
20:	10.2	↑
Serie		100 (6x)
Total		198 (8x)

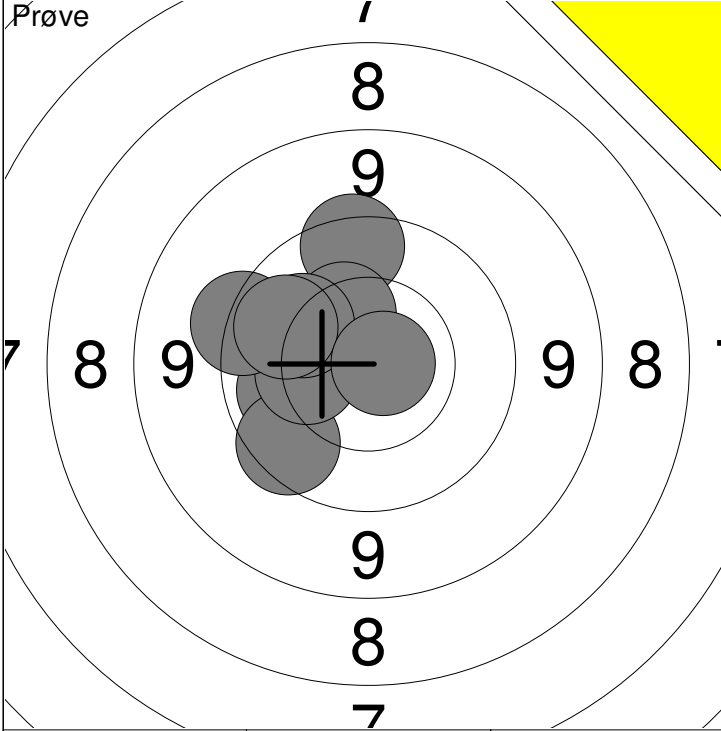

1: 10.1 ←	7: 9.5 ←	Serie	87 (1x)
2: 9.7 ↑	8: 10.2 ↖		
4: 10.4 ↗	9: 10.0 ↖	Total	0 (0x)
5: 9.8 ↙	10: 10.8x →		
6: 10.3 ←			

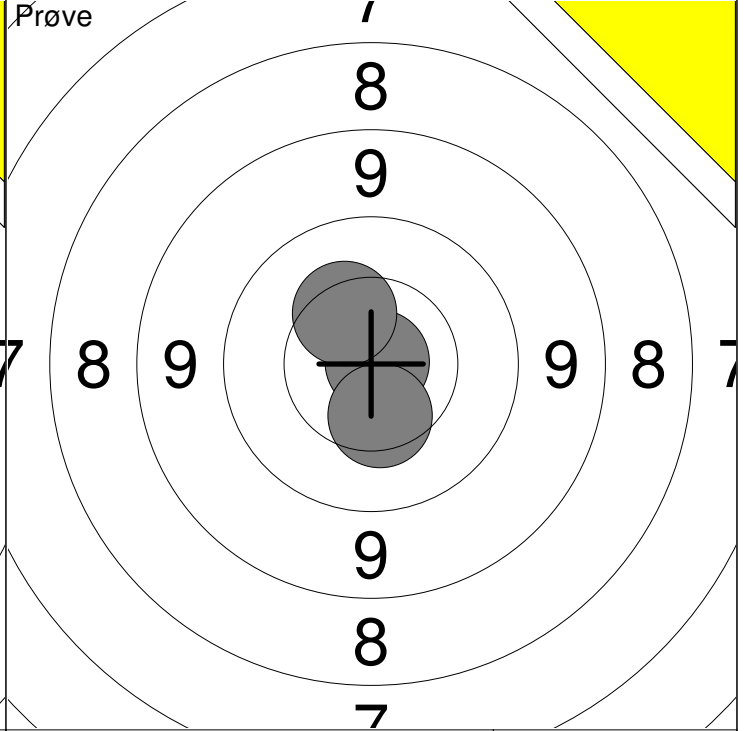

12: 10.9x →	Serie	30 (1x)
13: 10.4 ↓		
14: 10.4 ↗	Total	0 (0x)

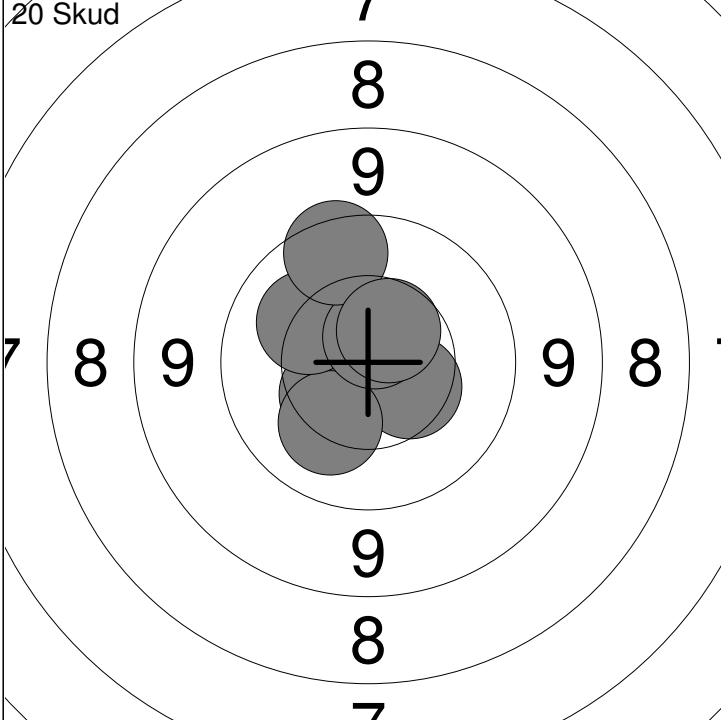

1: 10.6x ↖	6: 10.2 ↙	Serie	99 (4x)
2: 10.7x ↖	7: 10.2 ↖		
3: 10.4 ↙	8: 10.7x ↑	Total	99 (4x)
4: 10.9x ↘	9: 9.7 ↑		
5: 10.4 ↘	10: 10.6 ↗		

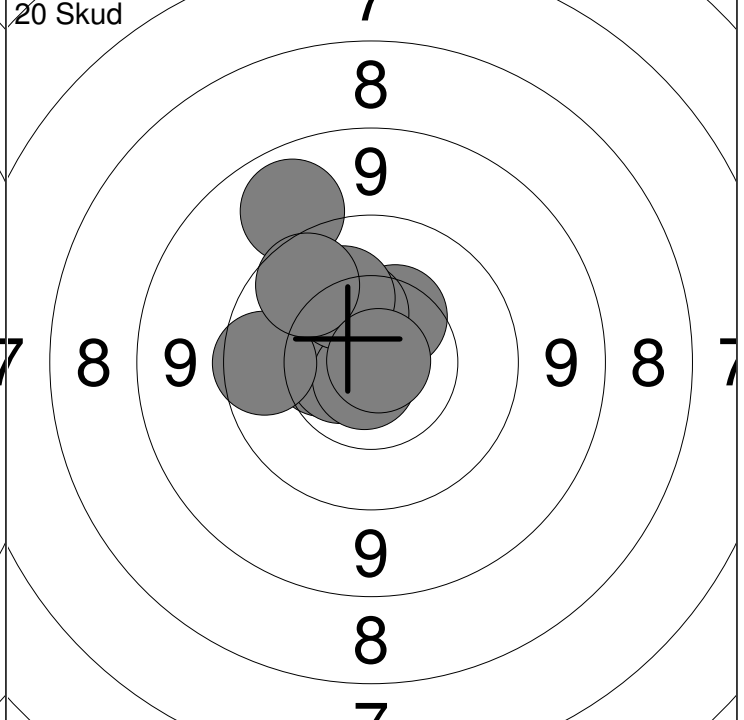

11: 10.4 ↗	16: 10.8x ↓	Serie	97 (3x)
12: 9.1 ↖	17: 10.2 ↖		
13: 10.4 ↗	18: 9.8 ←	Total	196 (7x)
14: 10.4 ←	19: 9.9 ↖		
15: 10.6x ←	20: 10.9x →		

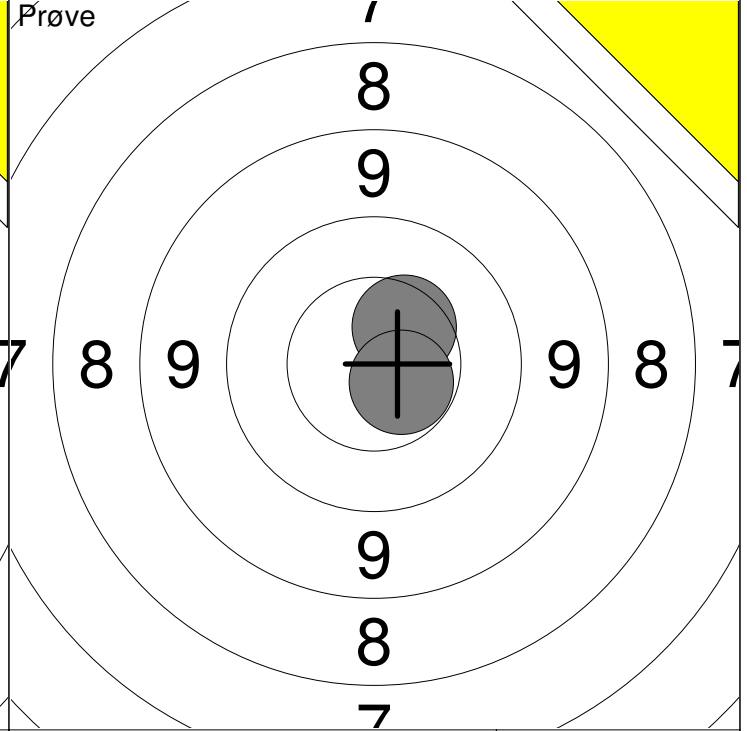
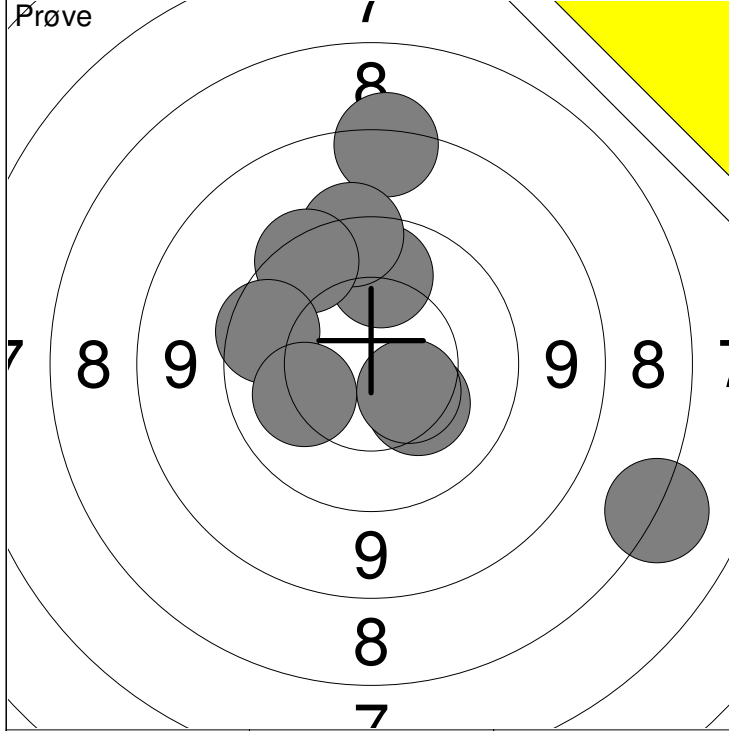

1: 8.5 ↑	7: 10.2 ←	Serie 82 (0x)
2: 10.0 ↑	8: 10.3 ↘	
4: 9.5 ↑	9: 7.3 ↘	Total 0 (0x)
5: 9.7 ↗	10: 10.5 ↘	
6: 9.8 ←		

11: 10.4 ↗	Serie 20 (1x)
12: 10.6x ↘	
	Total 0 (0x)

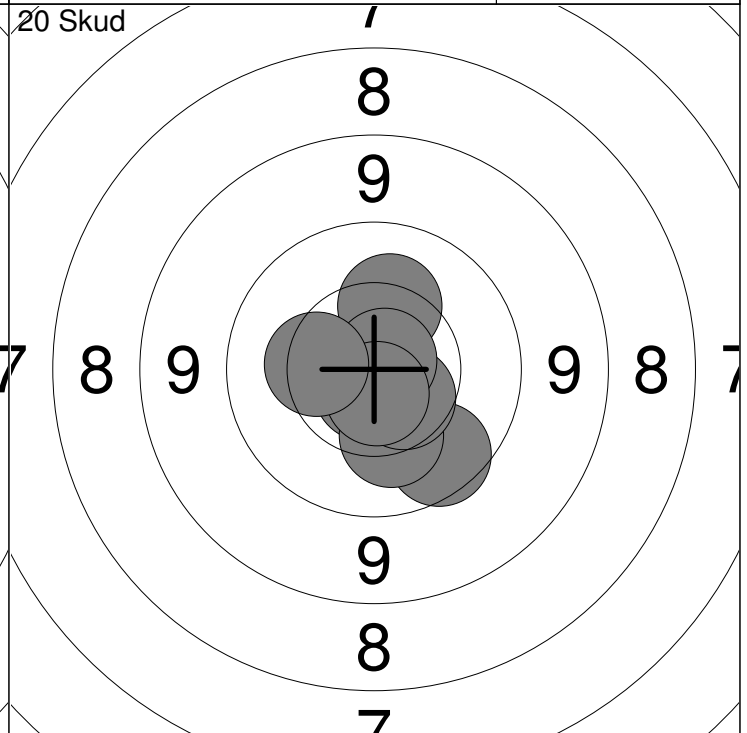
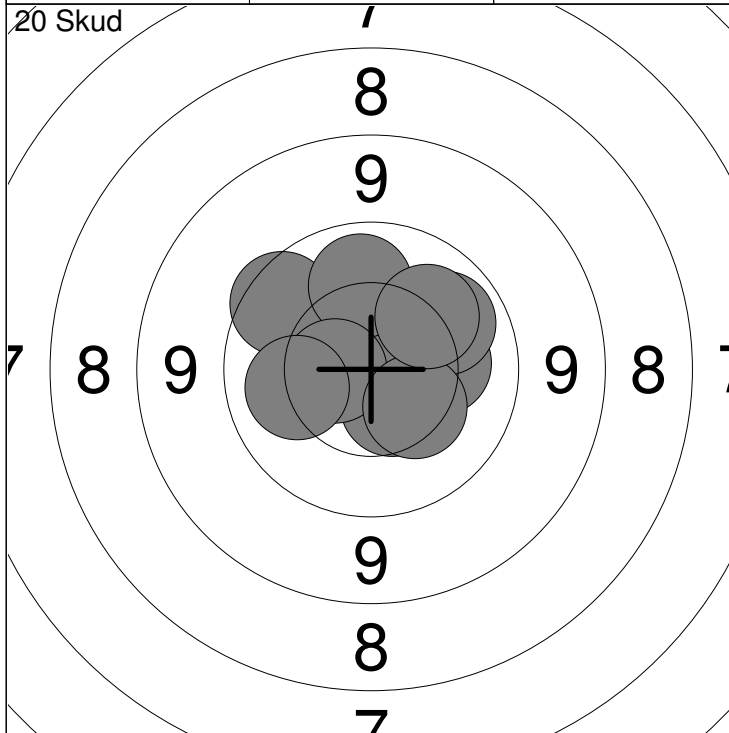

1: 10.2 →	6: 10.1 ↑	Serie 99 (0x)
2: 10.5 ↘	7: 10.6 ←	
3: 10.0 ↗	8: 10.2 ←	Total 99 (0x)
4: 9.8 ↖	9: 10.3 ↘	
5: 10.4 ↗	10: 10.1 ↗	

11: 10.7x ↘	16: 10.8x ↘	Serie 99 (4x)
12: 10.3 ↑	17: 10.5 ↘	
13: 9.8 ↘	18: 10.8x ↗	Total 198 (4x)
14: 10.6 ↘	19: 10.7x ↘	
15: 10.2 ↘	20: 10.3 ←	

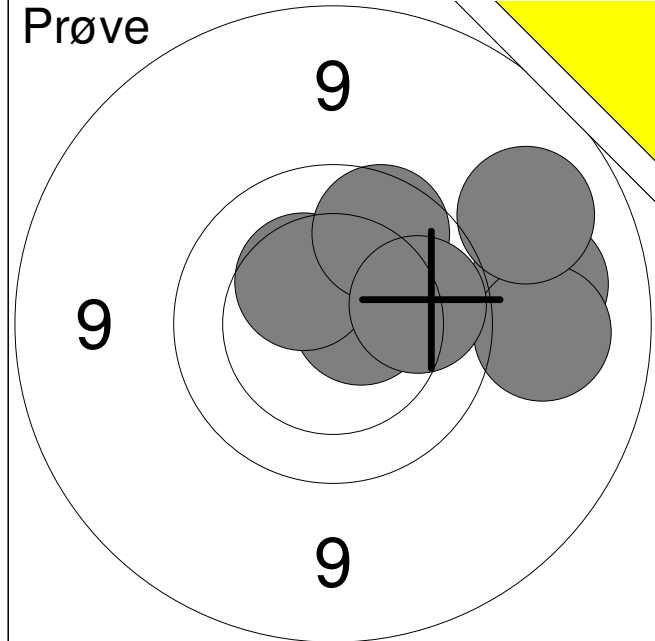

1:	9.2	→
2:	9.2	→
3:	10.6x	→
4:	10.4	↗
5:	9.9	↗
6:	10.0	→
7:	9.1	↘
Serie	66 (1x)	
Total	0 (0x)	

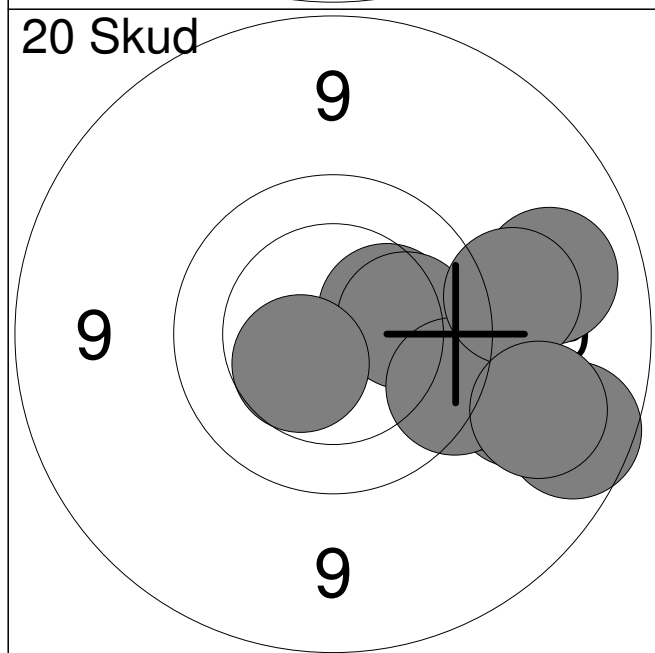

1:	10.3	↗
2:	10.1	→
3:	9.3	↘
4:	9.5	↘
5:	9.1	→
6:	9.7	↘
7:	10.5	↙
8:	8.9	↘
9:	9.4	→
10:	9.1	↘
Serie	92 (0x)	
Total	92 (0x)	

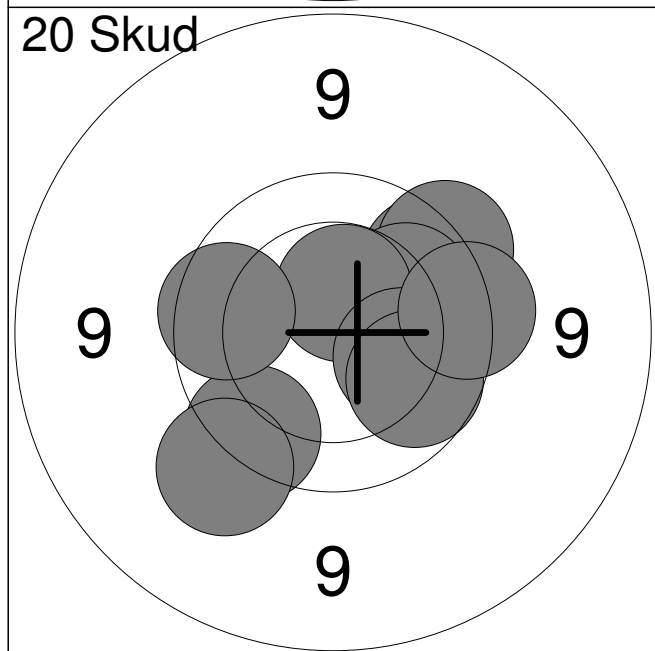

11:	9.7	↙
12:	9.8	↗
13:	9.6	↗
14:	10.0	↗
15:	10.5x	↗
16:	10.1	→
17:	9.4	↙
18:	9.8	←
19:	9.9	↘
20:	9.7	→
Serie	93 (1x)	
Total	185 (1x)	

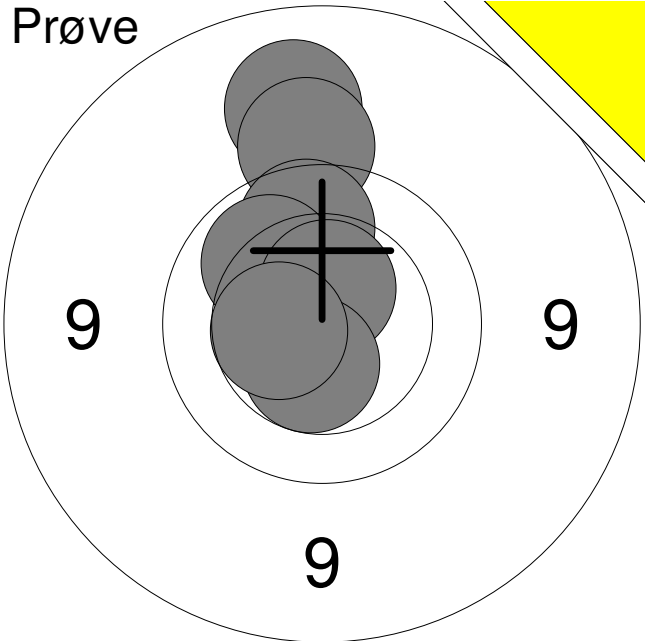
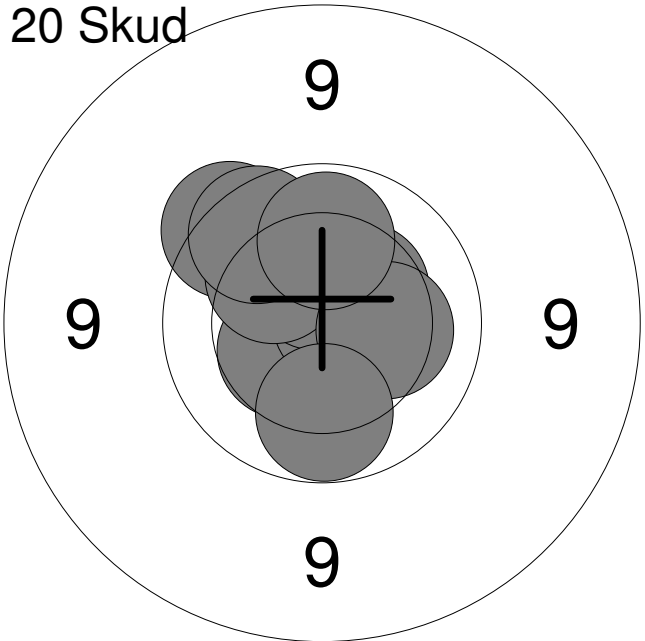
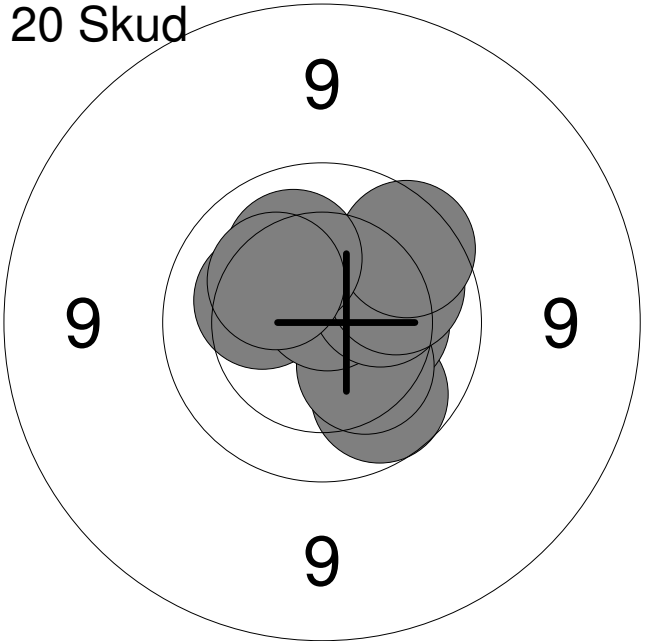
Hold 22	Skive 9	Rasmus Mikkelsen		
15 meter		Vilsted Skytteforening		BK1
		Nordjysk mesterskab 2019	Aalborg Skyttekreds	
Prøve 	1:	9.2	↑	
	2:	9.4	↑	
	3:	9.9	↑	
	4:	10.1	↗	
	5:	10.5x	↑	
	6:	10.5x	↓	
	7:	10.5	←	
Serie		67 (2x)		
Total		0 (0x)		
20 Skud 	1:	10.4	↙	
	2:	9.7	↗	
	3:	10.4	↗	
	4:	10.7x	→	
	5:	10.5	↑	
	6:	10.2	↗	
	7:	9.8	↗	
	8:	10.2	→	
	9:	10.0	↑	
	10:	10.0	↓	
Serie		98 (1x)		
Total		98 (1x)		
20 Skud 	11:	9.9	↘	
	12:	10.2	←	
	13:	10.3	→	
	14:	10.3	↘	
	15:	10.7x	↑	
	16:	10.3	→	
	17:	10.0	↗	
	18:	9.8	↗	
	19:	10.2	↑	
	20:	10.3	↖	
Serie		98 (1x)		
Total		196 (2x)		

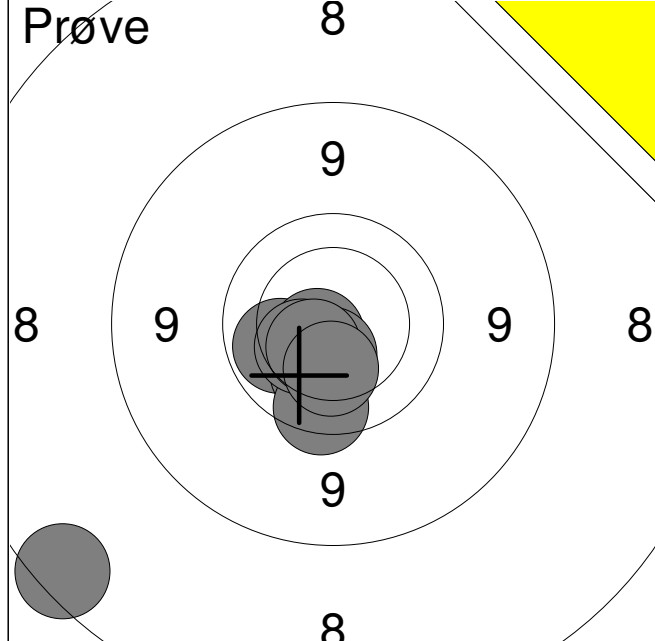

1:	7.8	↙
2:	10.0	←
3:	10.3	↙
4:	10.2	↙
5:	9.8	↙
6:	10.6x	←
7:	10.5	↙
8:	10.3	←
9:	10.5	↙
10:	10.2	↙

Serie 96 (1x)

Total 0 (0x)

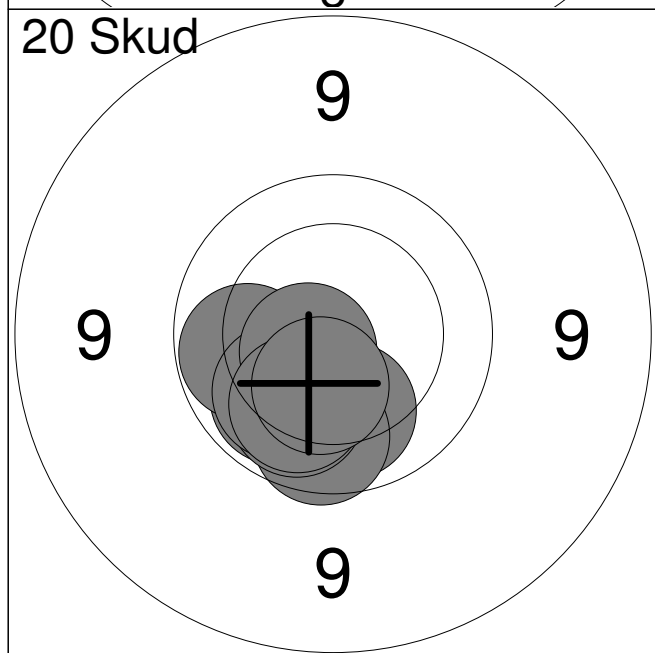

1:	10.1	↙
2:	9.9	↙
3:	10.1	↙
4:	10.0	↙
5:	10.0	←
6:	10.0	↙
7:	10.1	↙
8:	10.6x	←
9:	10.1	↙
10:	10.4	↙

Serie 99 (1x)

Total 99 (1x)

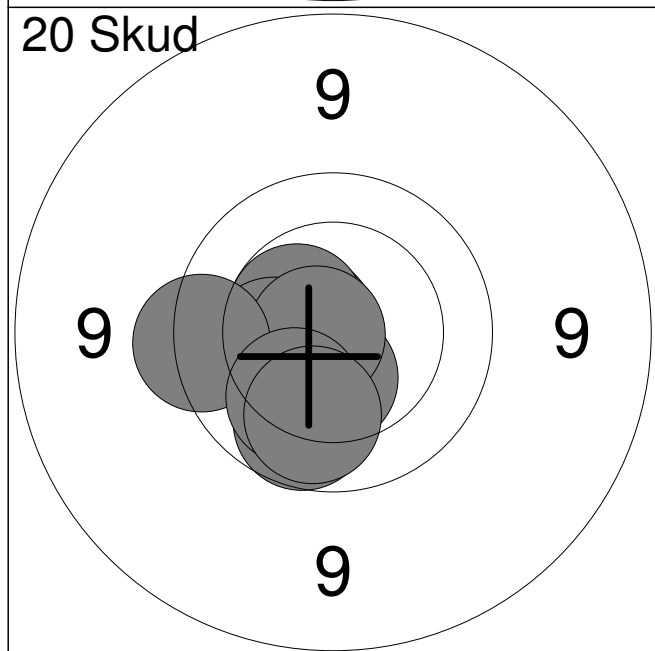

11:	10.3	←
12:	10.6x	←
13:	10.5x	↙
14:	10.3	←
15:	10.4	↙
16:	9.9	↙
17:	10.8x	←
18:	9.7	←
19:	10.1	↙
20:	10.0	↙

Serie 98 (3x)

Total 197 (4x)

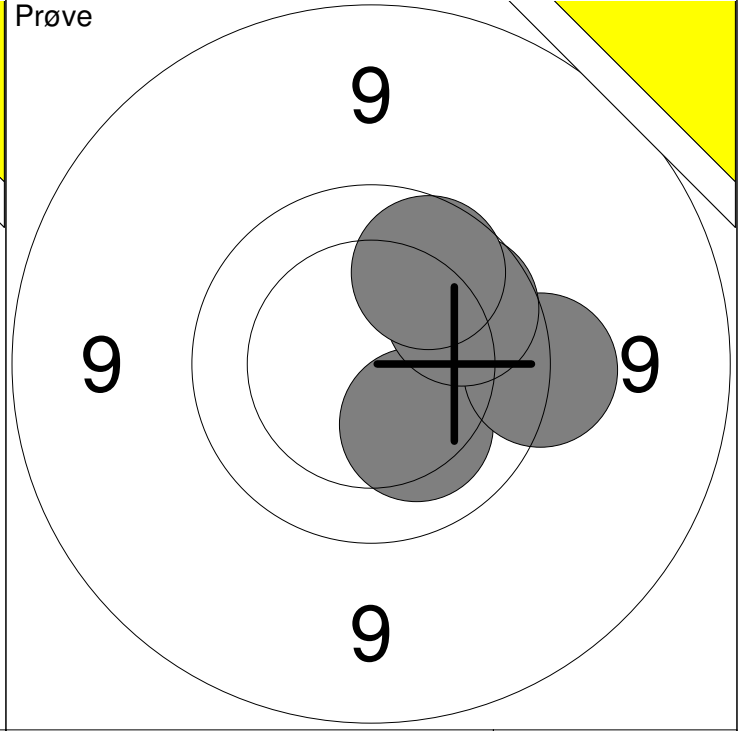
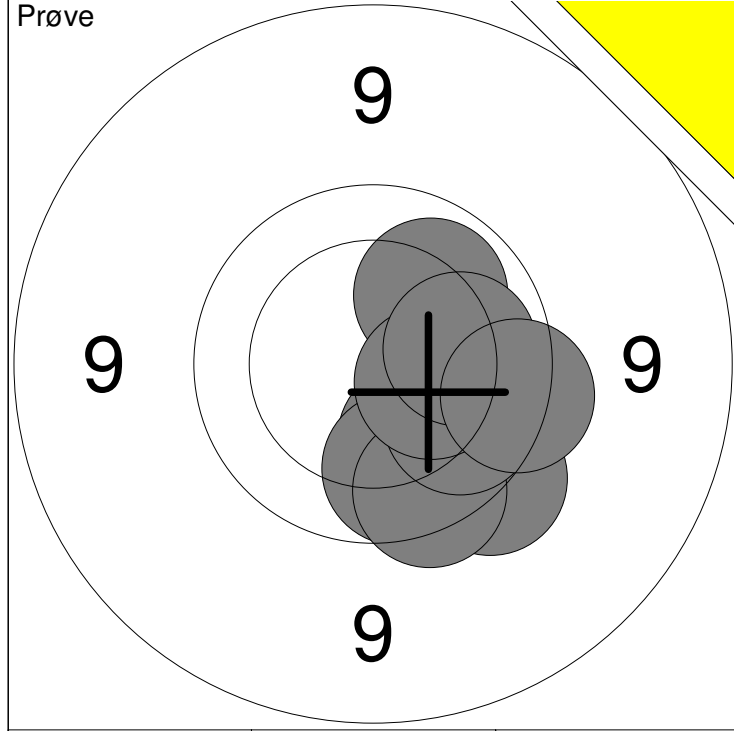

1: 10.1 ↘	6: 9.7 ↘	Serie	95 (0x)
2: 10.1 ↗	7: 9.9 ↘		
3: 10.0 ↘	8: 10.3 ↘	Total	0 (0x)
4: 9.6 ↘	9: 10.1 →		
5: 9.9 ↘	10: 9.7 →		

11: 10.2 ↘	Serie	37 (0x)
12: 9.6 →		
13: 9.9 ↗	Total	0 (0x)
14: 9.9 ↗		

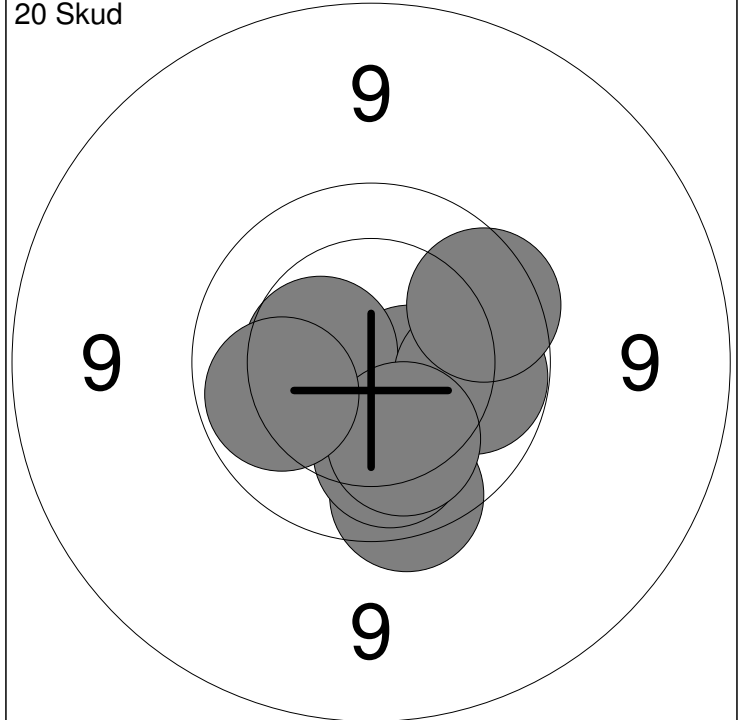
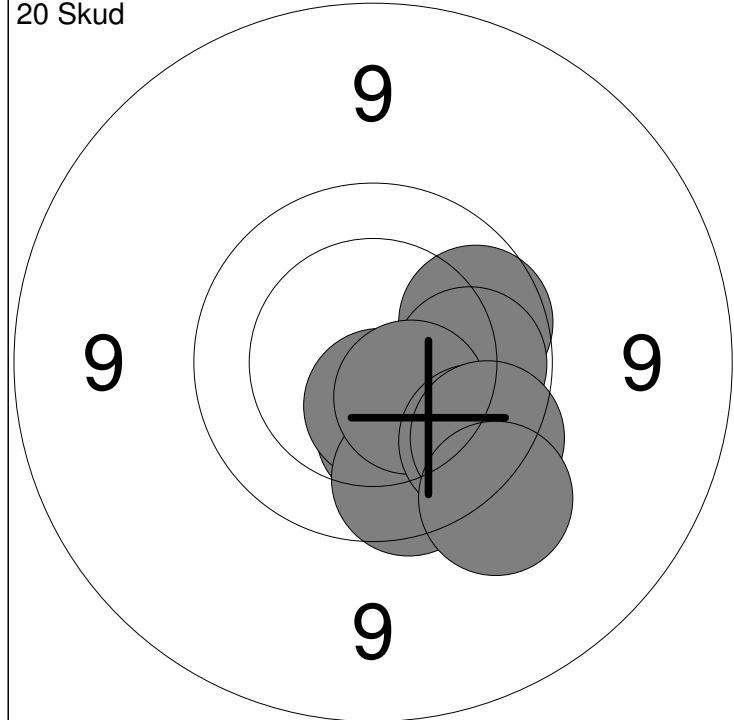

1: 9.9 ↗	6: 10.0 →	Serie	94 (1x)
2: 10.3 ↘	7: 10.5 ↘		
3: 9.9 ↘	8: 9.8 ↘	Total	94 (1x)
4: 10.5x ↘	9: 9.8 ↘		
5: 9.8 ↘	10: 9.5 ↘		

11: 10.3 ↘	16: 10.1 ↘	Serie	98 (1x)
12: 9.8 ↘	17: 10.0 →		
13: 10.5 ←	18: 10.1 ↘	Total	192 (2x)
14: 10.5x ↘	19: 9.8 ↗		
15: 10.4 ←	20: 10.0 ←		

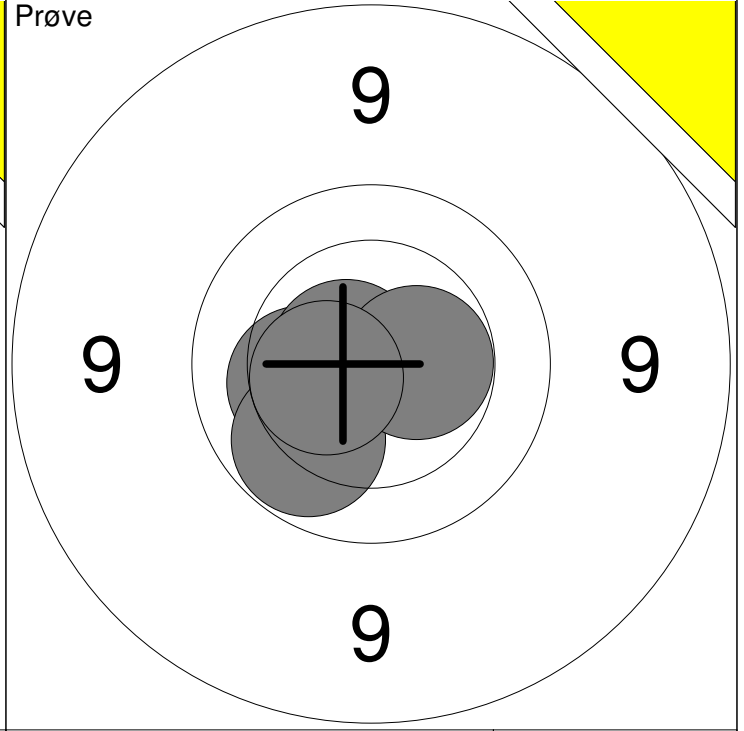
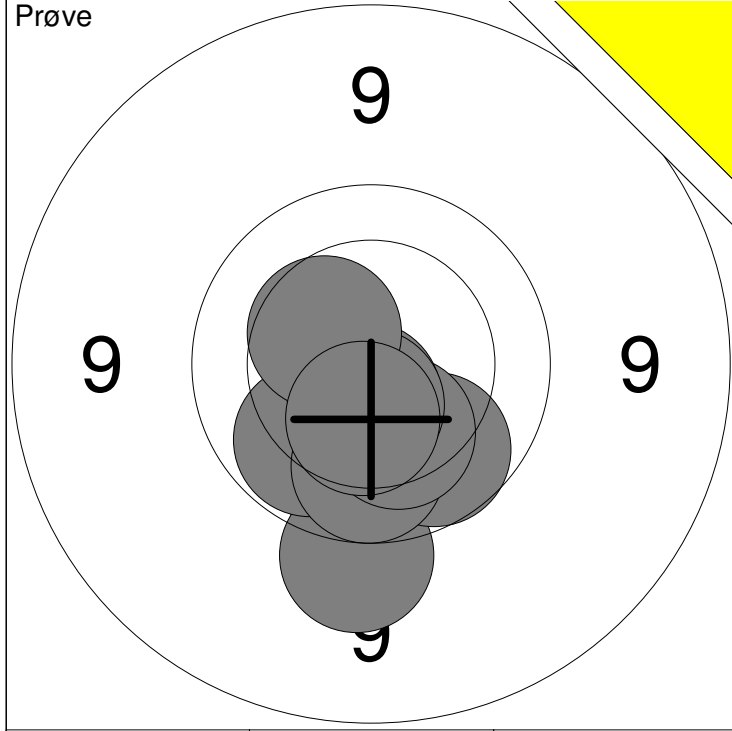

1: 9.9 ↓	6: 10.2 ↓	Serie	96 (2x)
2: 9.5 ↓	7: 10.6x ↓		
3: 10.0 ↙	8: 10.5x ↓	Total	0 (0x)
4: 9.9 ↘	9: 10.4 ↖		
5: 9.9 ↓	10: 10.4 ↓		

11: 10.3 ←	Serie	50 (3x)
12: 10.0 ↙		
13: 10.7x ←	Total	0 (0x)
14: 10.5x →		
15: 10.5x ←		

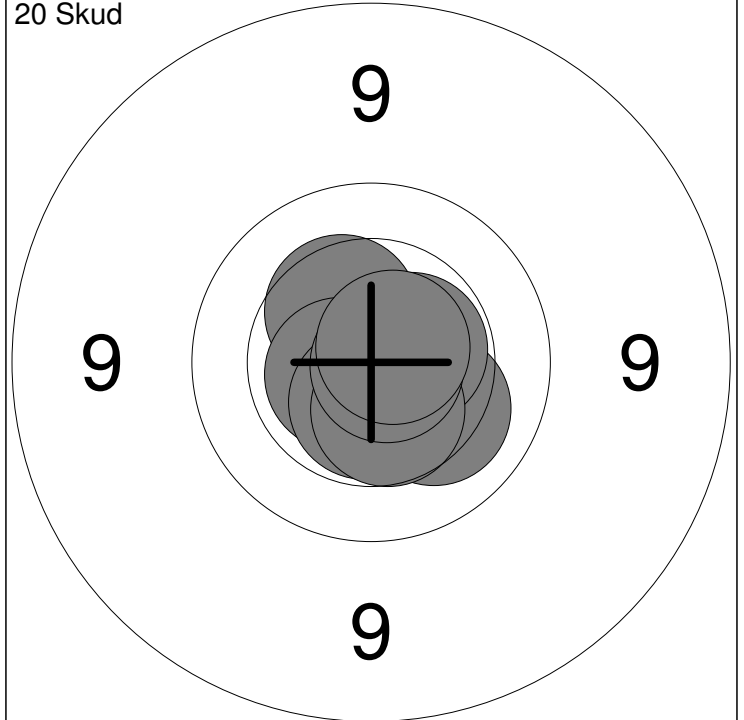
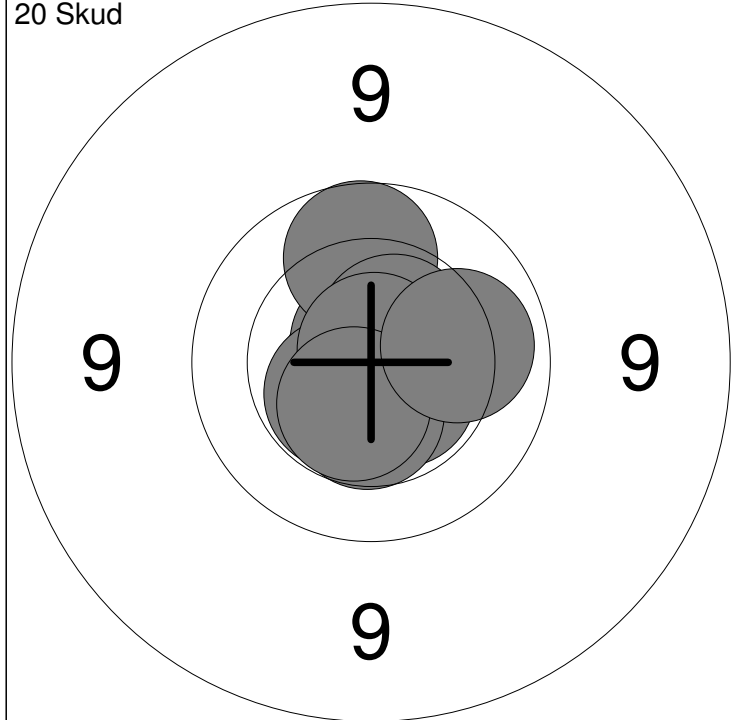

1: 10.8x ←	6: 9.9 ↑	Serie	99 (7x)
2: 10.8x ↑	7: 10.6x ↗		
3: 10.5x ↙	8: 10.8x ↑	Total	99 (7x)
4: 10.6x ↘	9: 10.5x ↓		
5: 10.5 ↓	10: 10.1 →		

11: 10.8x ↓	16: 10.6x ←	Serie	100 (7x)
12: 10.4 ↖	17: 10.6x ↓		
13: 10.7x ←	18: 10.5 ↓	Total	199 (14x)
14: 10.2 ↘	19: 10.8x →		
15: 10.5x →	20: 10.7x ↗		

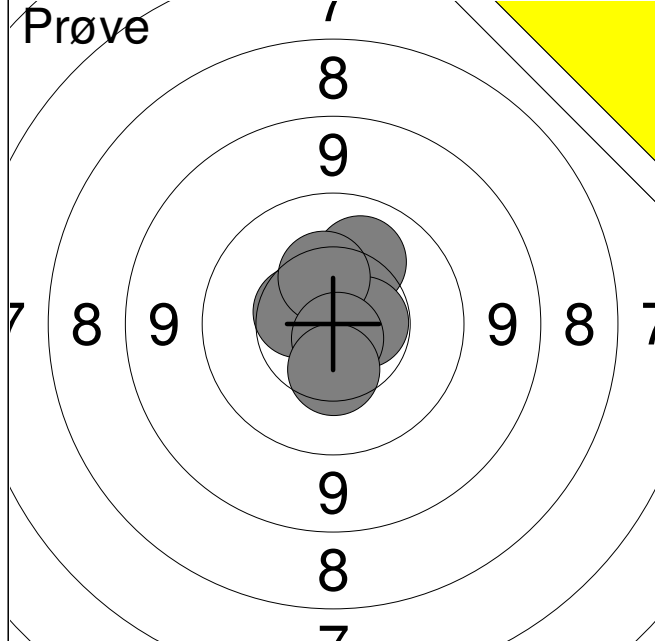

1:	10.5	↖
2:	10.2	↗
3:	10.6x	→
4:	10.4	↗
5:	10.8x	↘
6:	10.4	↘
Serie		60 (2x)
Total		0 (0x)

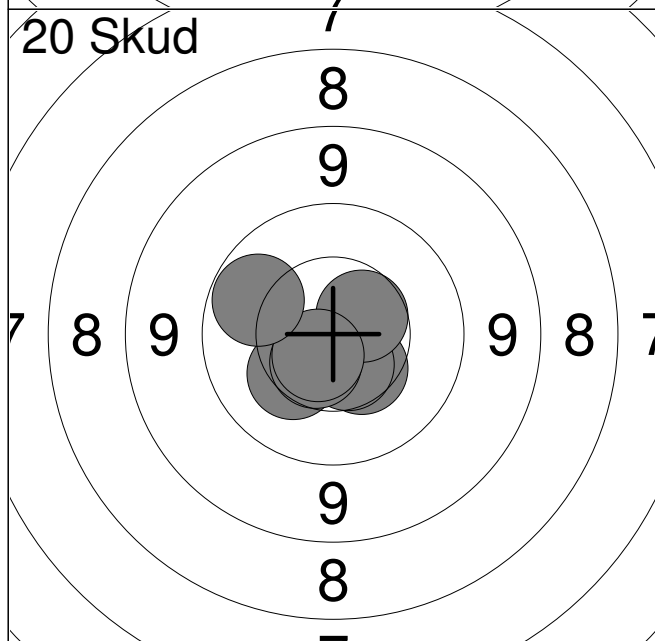

1:	10.6x	↘
2:	10.7x	↘
3:	10.7x	↘
4:	10.4	↘
5:	10.6	↘
6:	10.5	↗
7:	10.3	↖
8:	10.6	↘
9:	10.6x	↘
10:	10.0	↖
Serie		100 (4x)
Total		100 (4x)

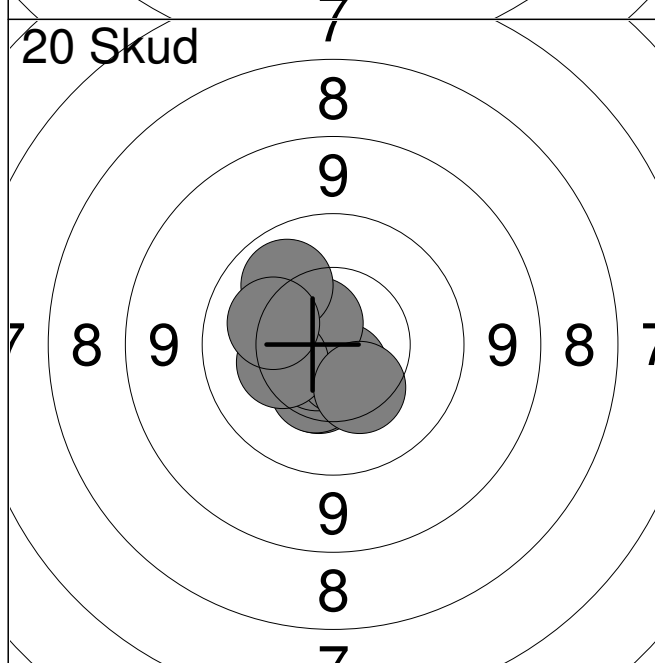

11:	10.4	↘
12:	10.6	↖
13:	10.4	↘
14:	10.6x	↘
15:	10.6x	↘
16:	10.6x	↗
17:	10.1	↗
18:	10.3	↖
19:	10.4	↘
20:	10.2	↖
Serie		100 (3x)
Total		200 (7x)

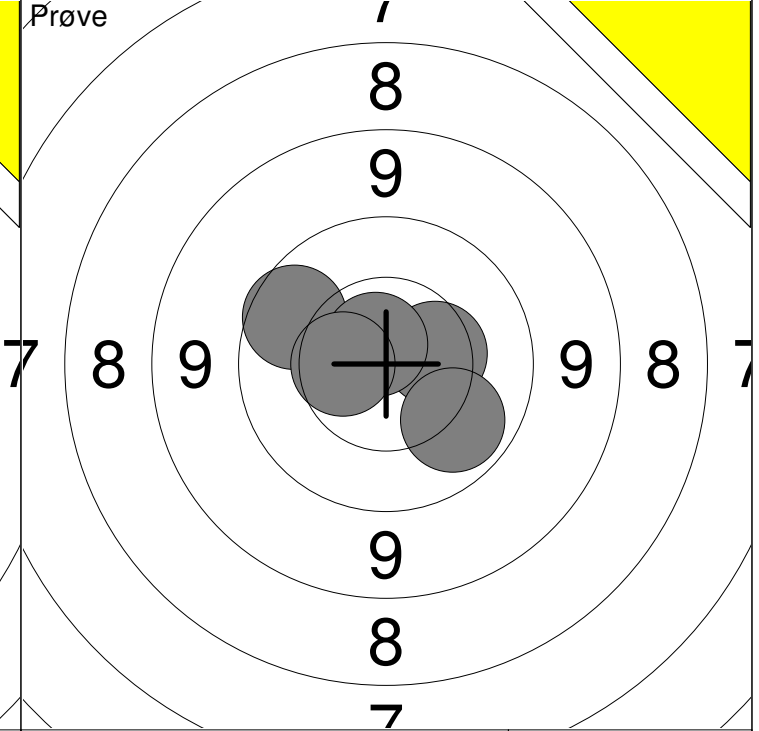
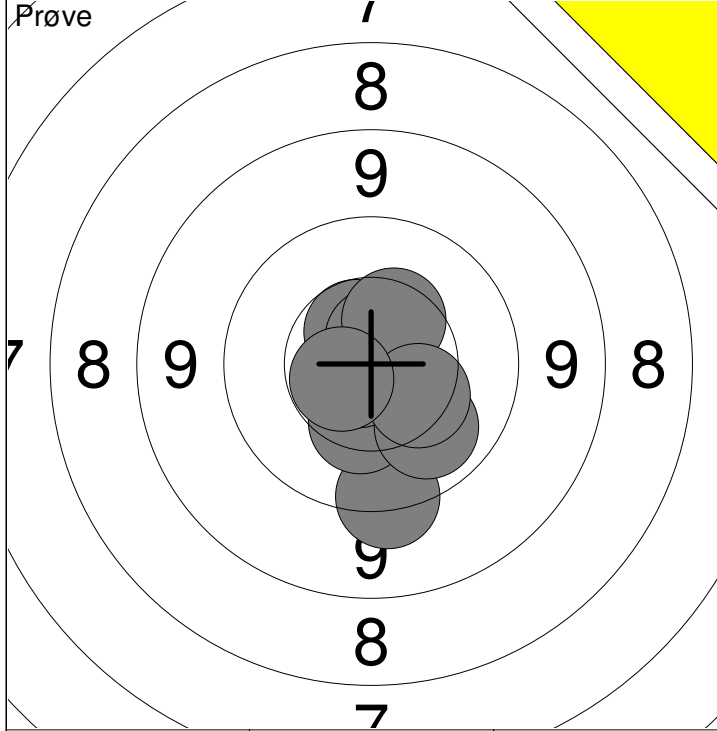

1: 9.5 ↓	6: 10.7x ↑	Serie 99 (4x)
2: 10.3 ↓	7: 10.1 ↘	
3: 10.8x ↙	8: 10.4 ↑	Total 0 (0x)
4: 10.8x ←	9: 10.4 ↘	
5: 10.6 ↗	10: 10.6x ↙	

11: 10.4 →	Serie 49 (1x)
12: 10.0 ↘	
13: 9.9 ↗	Total 0 (0x)
14: 10.7x ↑	
15: 10.5 ←	

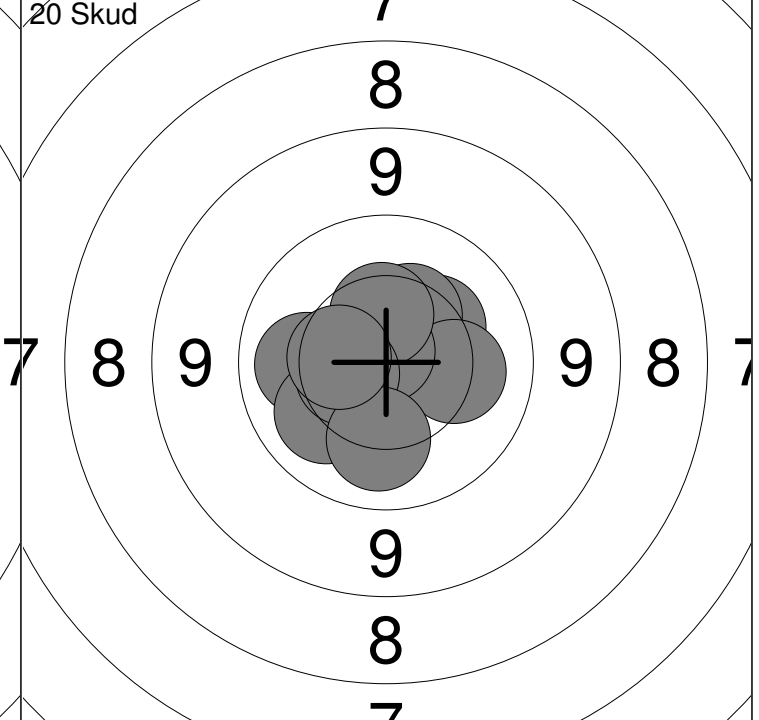
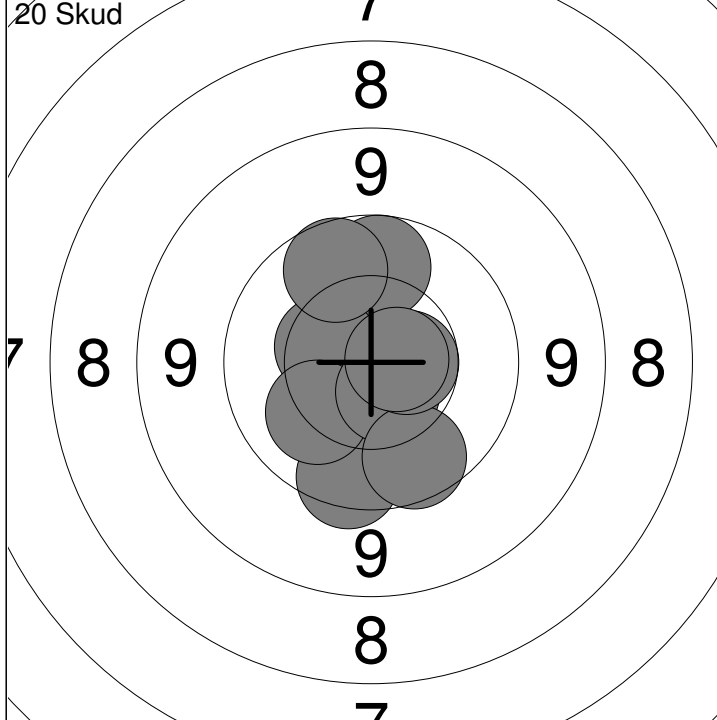

1: 9.9 ↑	6: 10.6x ↘	Serie 96 (3x)
2: 9.7 ↓	7: 9.9 ↘	
3: 10.7x ↘	8: 10.6 →	Total 96 (3x)
4: 10.5 ←	9: 9.9 ↗	
5: 10.2 ↙	10: 10.7x →	

11: 10.1 ←	16: 10.8x ↗	Serie 100 (1x)
12: 10.3 ↗	17: 10.5 ↑	
13: 10.4 ↑	18: 10.5 ←	Total 196 (4x)
14: 10.2 →	19: 10.2 ↓	
15: 10.1 ↙	20: 10.5 ←	

Hold 23	Skive 3	Johanne Axelsen	
-------------------	-------------------	------------------------	--

15 meter	Vester Hassing Skytteforening	MBK1	
----------	-------------------------------	------	--

Nordjysk mesterskab 2019		Aalborg Skyttekreds	
--------------------------	--	---------------------	--

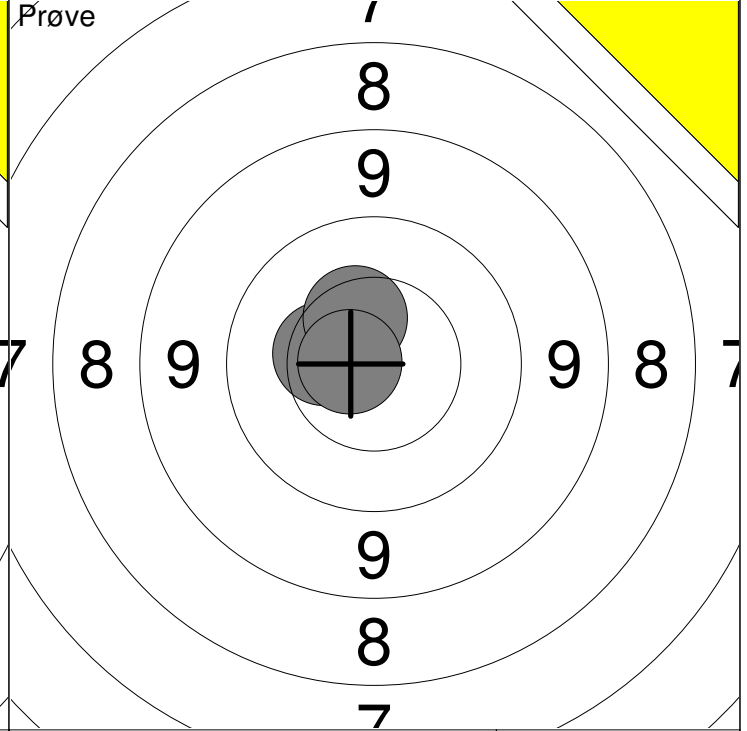
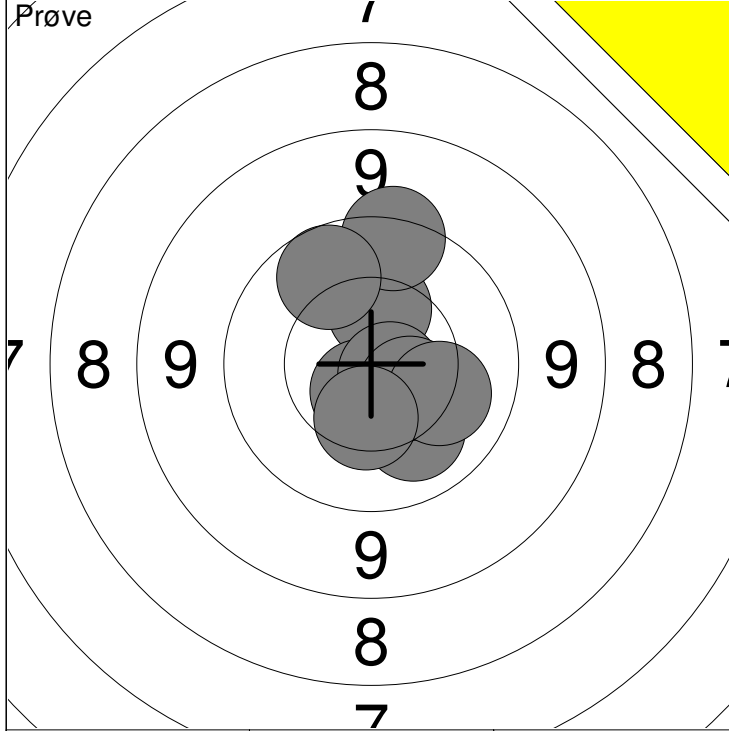

1: 10.4 ↑	6: 10.7x ↘	Serie	98 (2x)
2: 10.6x ↓	7: 10.1 ↓		
3: 9.6 ↑	8: 10.5 ↘	Total	0 (0x)
4: 9.9 ↑	9: 10.2 ↘		
5: 10.4 ↘	10: 10.4 ↓		

11: 10.4 ←	Serie	30 (1x)
12: 10.4 ↑		
13: 10.7x ←	Total	0 (0x)

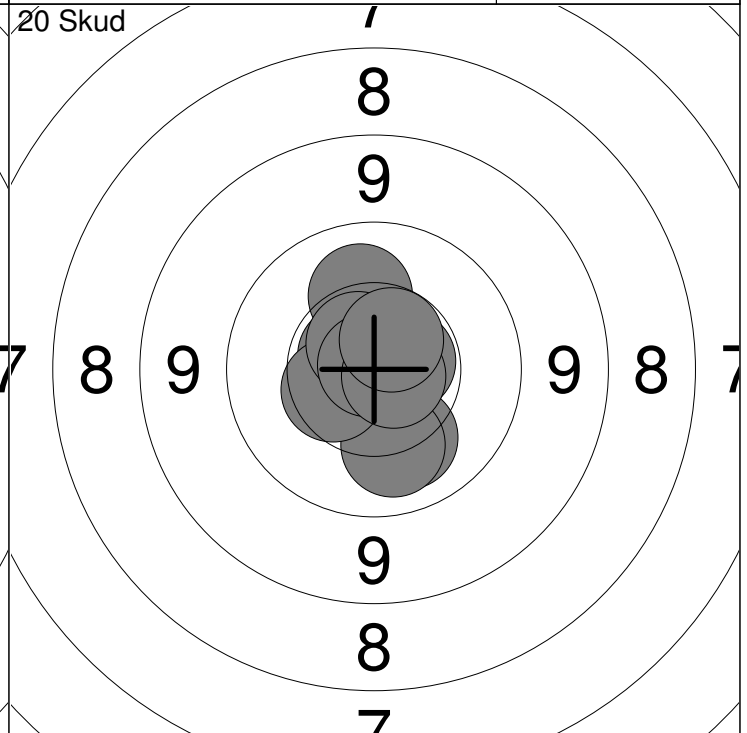
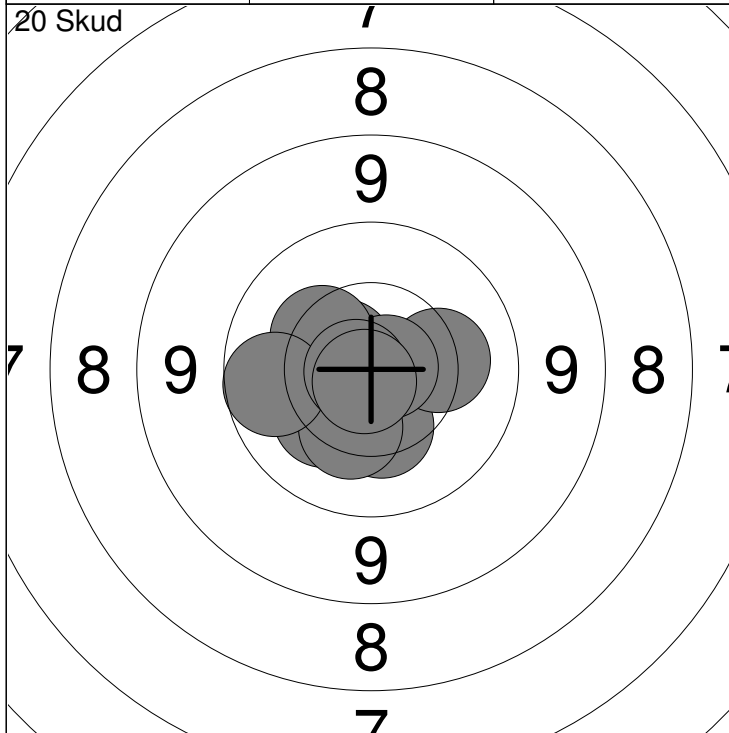

1: 10.3 ↓	6: 10.3 ↖	Serie	99 (4x)
2: 10.3 ↙	7: 10.3 ↓		
3: 10.2 →	8: 9.9 ←	Total	99 (4x)
4: 10.6x ↖	9: 10.8x ←		
5: 10.8x →	10: 10.8x ↓		

11: 10.2 ↓	16: 10.6x ↗	Serie	100 (6x)
12: 10.1 ↓	17: 10.6x →		
13: 10.7x ↖	18: 10.9x ↖	Total	199 (10x)
14: 10.5 ←	19: 10.7x →		
15: 10.2 ↑	20: 10.6x ↗		

	Nordjysk mesterskab 2019	Aalborg Skyttekreds
--	--------------------------	---------------------

Prøve

1:	10.8x	←
2:	10.6	←
3:	10.2	↓
4:	10.4	↗
5:	10.3	↘
6:	10.5	→
7:	10.8x	←
8:	10.5	↗
9:	10.7x	←

Serie	90 (3x)
Total	0 (0x)

20 Skud

1:	10.9x	↗
2:	10.4	↖
3:	10.4	↑
4:	9.8	↗
5:	10.7x	↘
6:	10.0	↑
7:	9.9	↓
8:	10.1	↗
9:	10.5	↑
10:	10.6x	↖

Serie	98 (3x)
Total	98 (3x)

20 Skud

11:	10.5	↘
12:	10.4	↘
13:	10.8x	↓
14:	10.7x	↓
15:	10.9x	↖
16:	10.6x	↗
17:	10.2	↑
18:	10.6	↗
19:	10.3	↘
20:	10.2	↑

Serie	100 (4x)
Total	198 (7x)

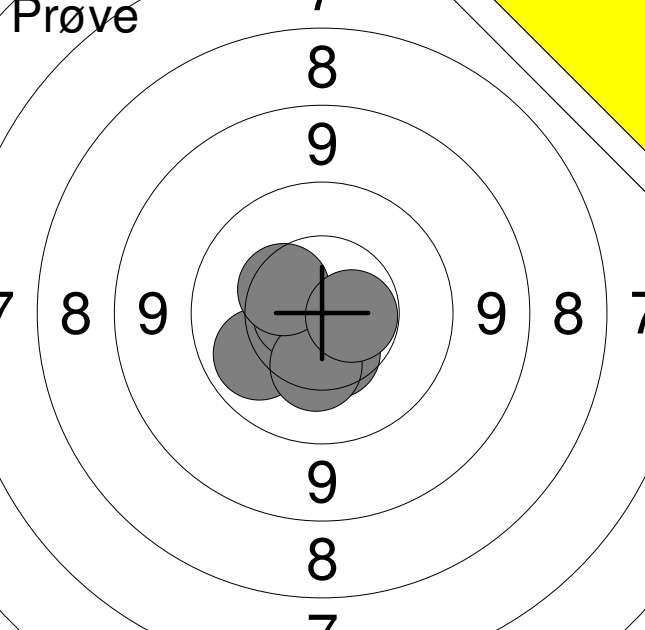
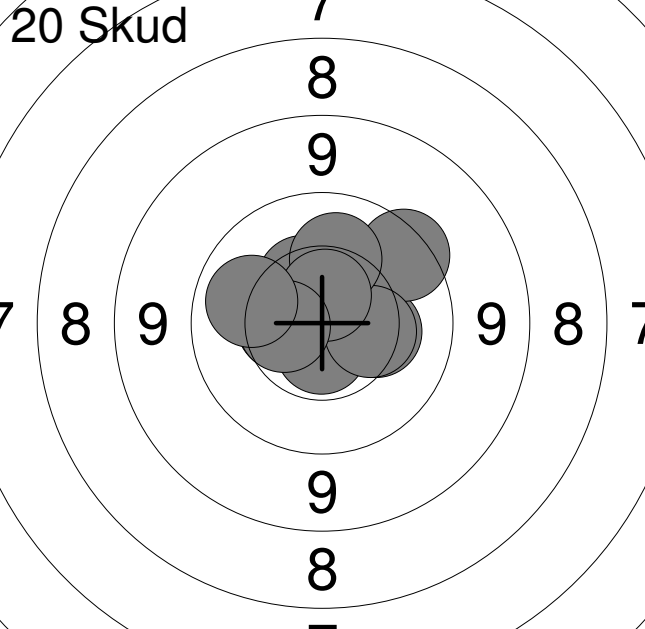
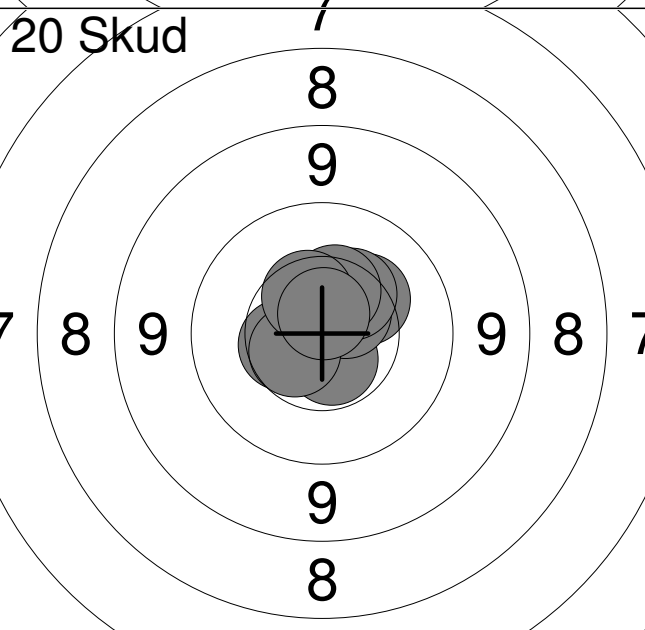
	Nordjysk mesterskab 2019	Aalborg Skyttekreds																															
Prøve 			<table style="width:100%; border-collapse: collapse;"> <tr><td>1:</td><td>10.1</td><td style="text-align: right;">↖</td></tr> <tr><td>2:</td><td>10.5</td><td style="text-align: right;">↓</td></tr> <tr><td>3:</td><td>10.7x</td><td style="text-align: right;">←</td></tr> <tr><td>4:</td><td>10.8x</td><td style="text-align: right;">↓</td></tr> <tr><td>5:</td><td>10.3</td><td style="text-align: right;">↓</td></tr> <tr><td>6:</td><td>10.4</td><td style="text-align: right;">↗</td></tr> <tr><td>7:</td><td>10.6x</td><td style="text-align: right;">→</td></tr> </table>	1:	10.1	↖	2:	10.5	↓	3:	10.7x	←	4:	10.8x	↓	5:	10.3	↓	6:	10.4	↗	7:	10.6x	→									
1:	10.1	↖																															
2:	10.5	↓																															
3:	10.7x	←																															
4:	10.8x	↓																															
5:	10.3	↓																															
6:	10.4	↗																															
7:	10.6x	→																															
	Serie		70 (3x)																														
	Total		0 (0x)																														
20 Skud 			<table style="width:100%; border-collapse: collapse;"> <tr><td>1:</td><td>10.3</td><td style="text-align: right;">→</td></tr> <tr><td>2:</td><td>9.7</td><td style="text-align: right;">↗</td></tr> <tr><td>3:</td><td>10.4</td><td style="text-align: right;">↗</td></tr> <tr><td>4:</td><td>10.7x</td><td style="text-align: right;">↓</td></tr> <tr><td>5:</td><td>10.4</td><td style="text-align: right;">→</td></tr> <tr><td>6:</td><td>10.5</td><td style="text-align: right;">←</td></tr> <tr><td>7:</td><td>10.2</td><td style="text-align: right;">↑</td></tr> <tr><td>8:</td><td>10.6x</td><td style="text-align: right;">↑</td></tr> <tr><td>9:</td><td>10.5</td><td style="text-align: right;">←</td></tr> <tr><td>10:</td><td>10.1</td><td style="text-align: right;">←</td></tr> </table>	1:	10.3	→	2:	9.7	↗	3:	10.4	↗	4:	10.7x	↓	5:	10.4	→	6:	10.5	←	7:	10.2	↑	8:	10.6x	↑	9:	10.5	←	10:	10.1	←
1:	10.3	→																															
2:	9.7	↗																															
3:	10.4	↗																															
4:	10.7x	↓																															
5:	10.4	→																															
6:	10.5	←																															
7:	10.2	↑																															
8:	10.6x	↑																															
9:	10.5	←																															
10:	10.1	←																															
	Serie		99 (2x)																														
	Total		99 (2x)																														
20 Skud 			<table style="width:100%; border-collapse: collapse;"> <tr><td>11:</td><td>10.5</td><td style="text-align: right;">←</td></tr> <tr><td>12:</td><td>10.4</td><td style="text-align: right;">↗</td></tr> <tr><td>13:</td><td>10.3</td><td style="text-align: right;">↗</td></tr> <tr><td>14:</td><td>10.6x</td><td style="text-align: right;">↓</td></tr> <tr><td>15:</td><td>10.6</td><td style="text-align: right;">↗</td></tr> <tr><td>16:</td><td>10.4</td><td style="text-align: right;">↗</td></tr> <tr><td>17:</td><td>10.4</td><td style="text-align: right;">↑</td></tr> <tr><td>18:</td><td>10.6</td><td style="text-align: right;">←</td></tr> <tr><td>19:</td><td>10.5</td><td style="text-align: right;">↑</td></tr> <tr><td>20:</td><td>10.7x</td><td style="text-align: right;">↑</td></tr> </table>	11:	10.5	←	12:	10.4	↗	13:	10.3	↗	14:	10.6x	↓	15:	10.6	↗	16:	10.4	↗	17:	10.4	↑	18:	10.6	←	19:	10.5	↑	20:	10.7x	↑
11:	10.5	←																															
12:	10.4	↗																															
13:	10.3	↗																															
14:	10.6x	↓																															
15:	10.6	↗																															
16:	10.4	↗																															
17:	10.4	↑																															
18:	10.6	←																															
19:	10.5	↑																															
20:	10.7x	↑																															
	Serie		100 (2x)																														
	Total		199 (4x)																														

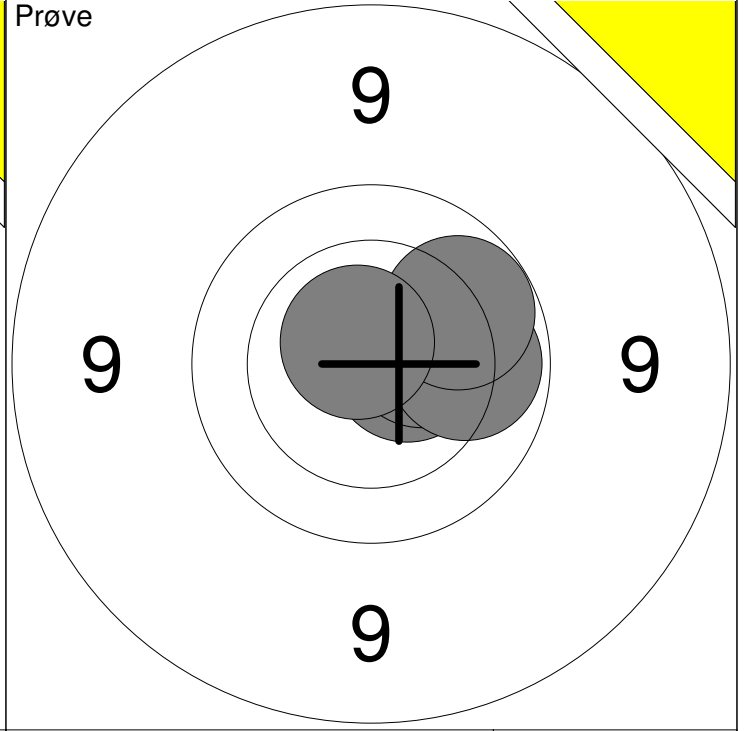
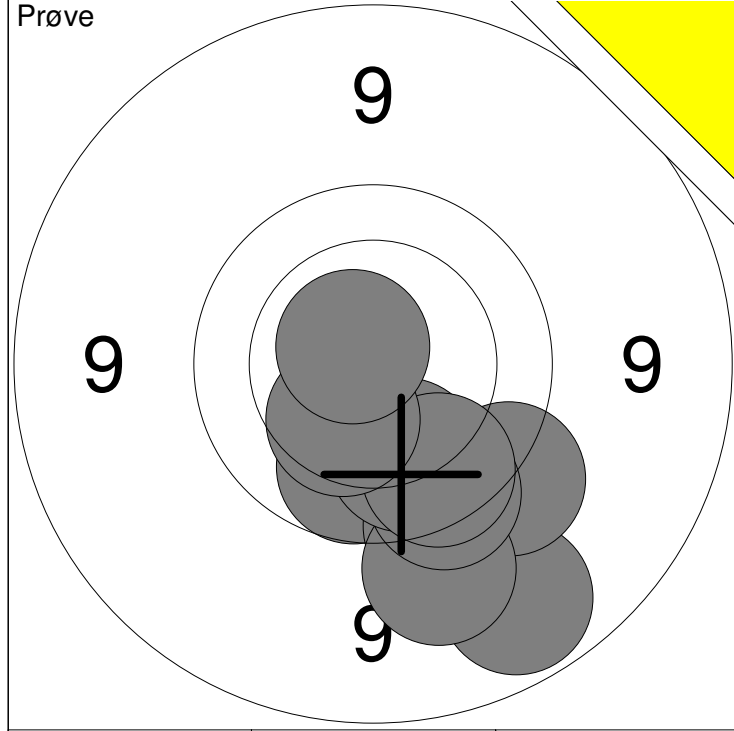

1: 9.9 ↓	6: 9.7 ↓	Serie	93 (1x)
2: 9.5 ↓	7: 10.0 ↓		
3: 9.0 ↓	8: 9.8 ↓	Total	0 (0x)
4: 9.5 ↓	9: 10.3 ↓		
5: 9.3 ↓	10: 10.7x ↗		

11: 10.6x →	Serie	50 (2x)
12: 10.4 →		
13: 10.0 →	Total	0 (0x)
14: 10.0 ↗		
15: 10.7x ↖		

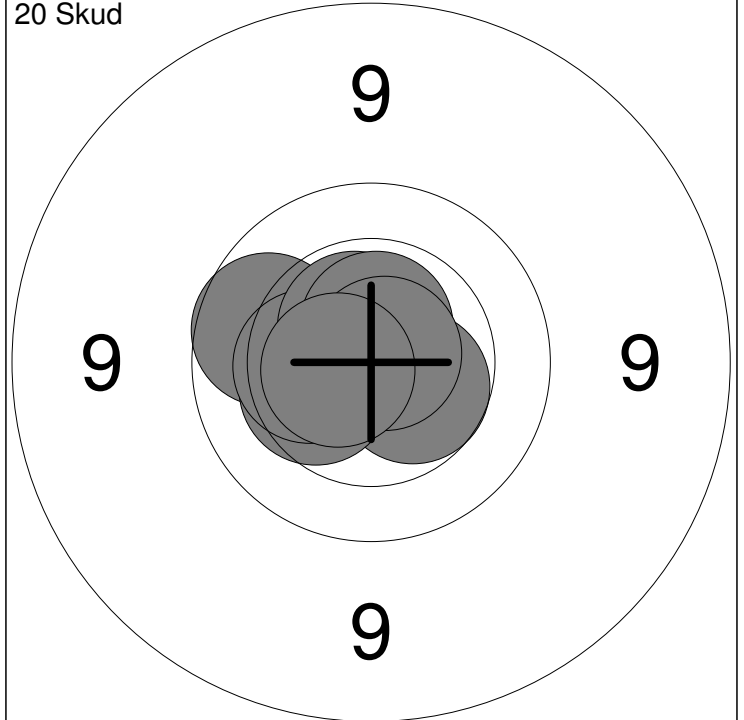
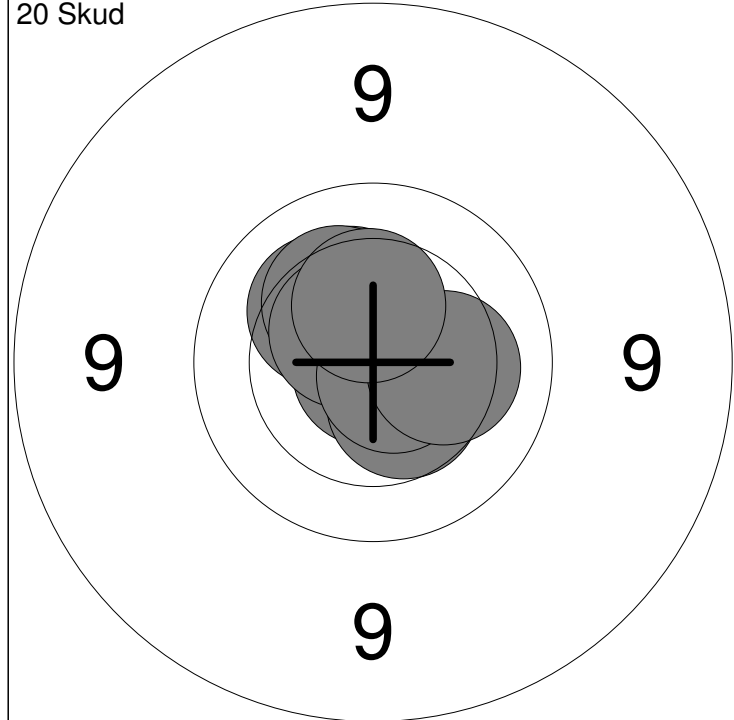

1: 10.3 ↗	6: 10.5 ↓	Serie	100 (3x)
2: 10.9x ↓	7: 10.5x ↗		
3: 10.3 ↗	8: 10.7x ↓	Total	100 (3x)
4: 10.5 ↗	9: 10.3 →		
5: 10.3 ↗	10: 10.4 ↑		

11: 10.7x ↘	16: 10.3 ←	Serie	99 (6x)
12: 10.8x →	17: 10.6x ↖		
13: 9.9 ←	18: 10.6x ↑	Total	199 (9x)
14: 10.5 ↘	19: 10.8x ↗		
15: 10.4 ←	20: 10.6x ←		

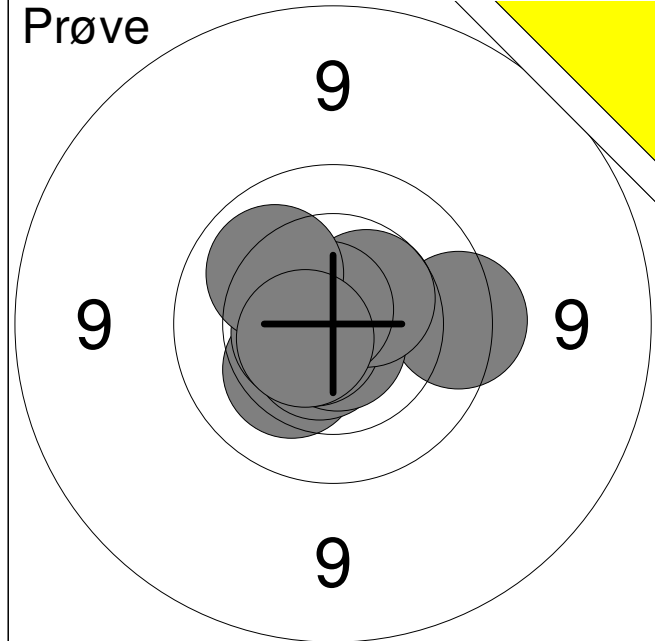

1:	9.7	→
2:	10.3	↙
3:	10.6x	↙
4:	10.7x	↓
5:	10.6x	←
6:	10.7x	↙
7:	10.5	↗
8:	10.8x	↗
9:	10.1	↗
10:	10.6x	↙
Serie		99 (6x)
Total		0 (0x)

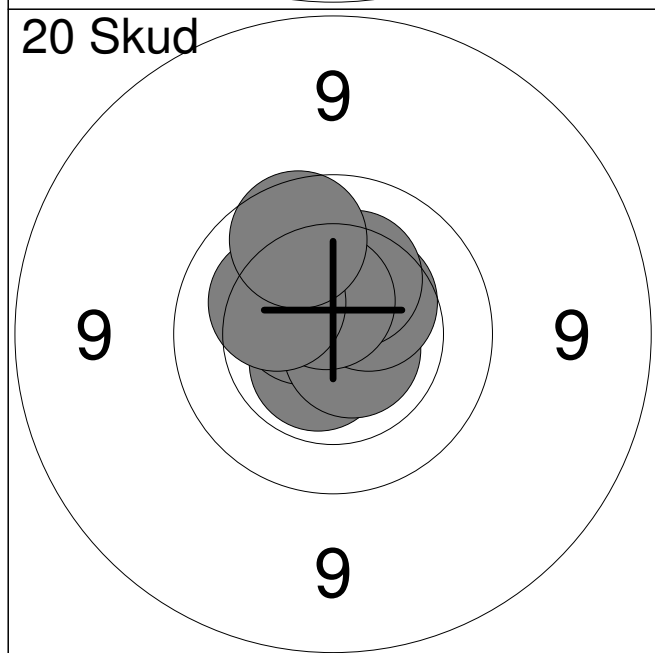

1:	10.7x	→
2:	10.6x	↙
3:	10.6x	↑
4:	10.6x	↗
5:	10.7x	↙
6:	10.4	↗
7:	10.3	↗
8:	10.6x	↑
9:	10.2	↙
10:	9.9	↑
Serie		99 (6x)
Total		99 (6x)

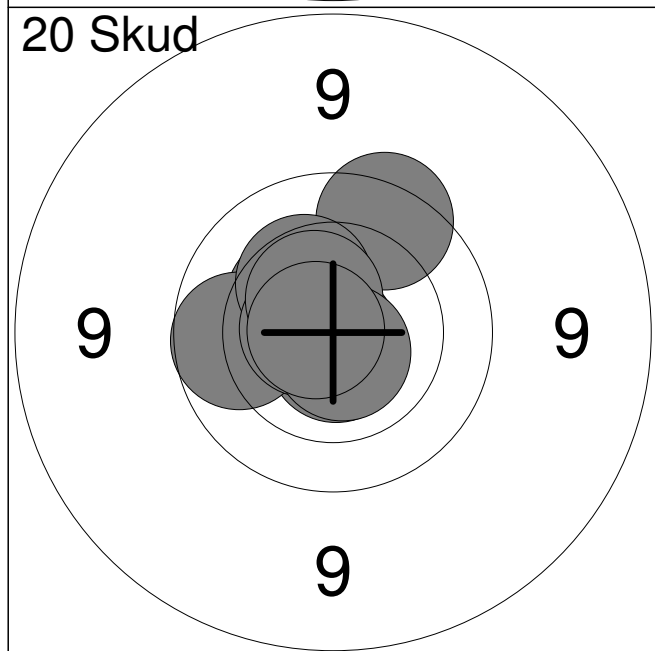

11:	10.4	↖
12:	10.7x	↓
13:	9.8	↗
14:	10.9x	↙
15:	9.9	←
16:	10.3	↗
17:	10.7x	←
18:	10.5x	↗
19:	10.7x	↓
20:	10.8x	←
Serie		98 (6x)
Total		197 (12x)

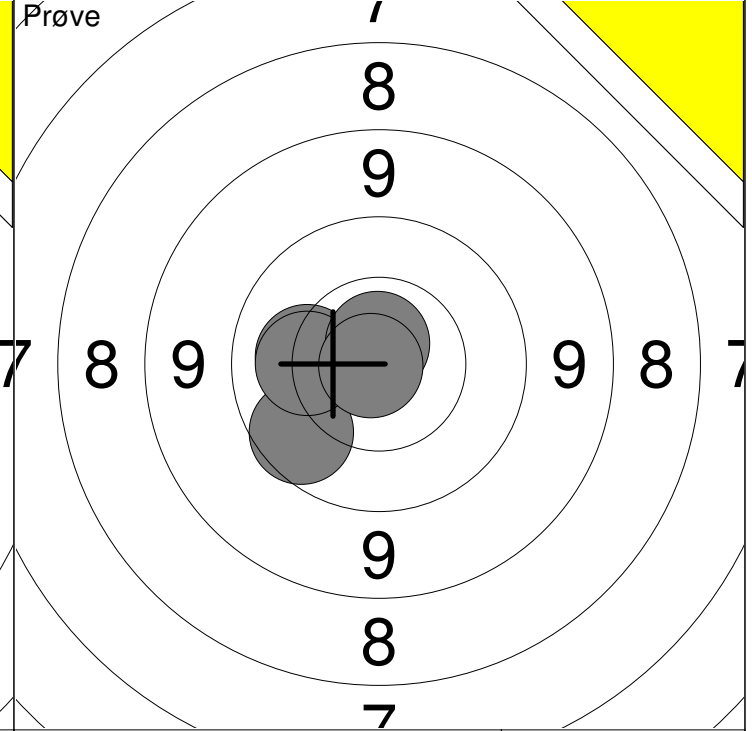
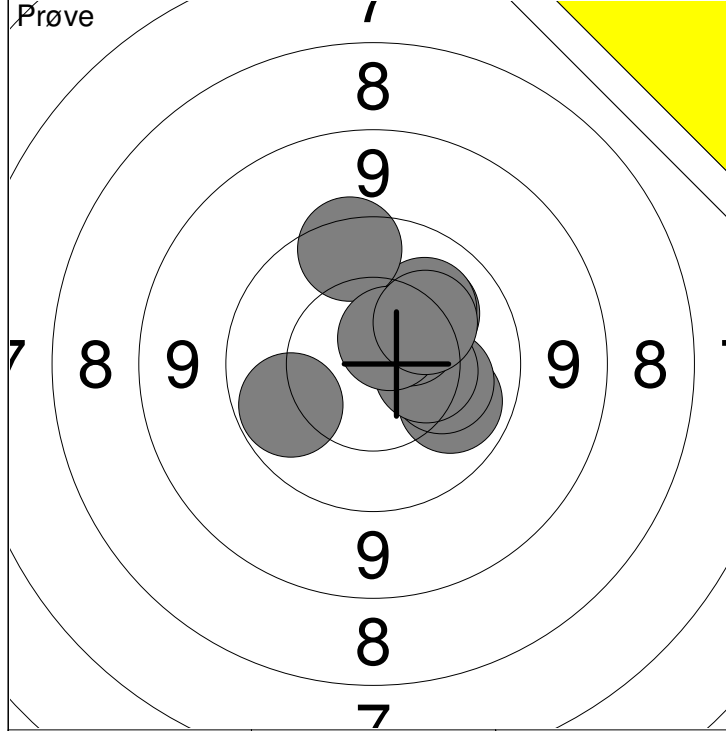

1: 10.1 →	6: 10.0 ←	Serie 99 (1x)
2: 10.2 →	7: 9.7 ↑	
3: 10.2 ↗	8: 10.5 ↗	Total 0 (0x)
4: 10.2 ↗	9: 10.6x ↗	
5: 10.4 →	10: 10.3 ↗	

11: 10.2 ←	Serie 49 (2x)
12: 9.9 ↙	
13: 10.2 ←	Total 0 (0x)
14: 10.7x ↑	
15: 10.9x ←	

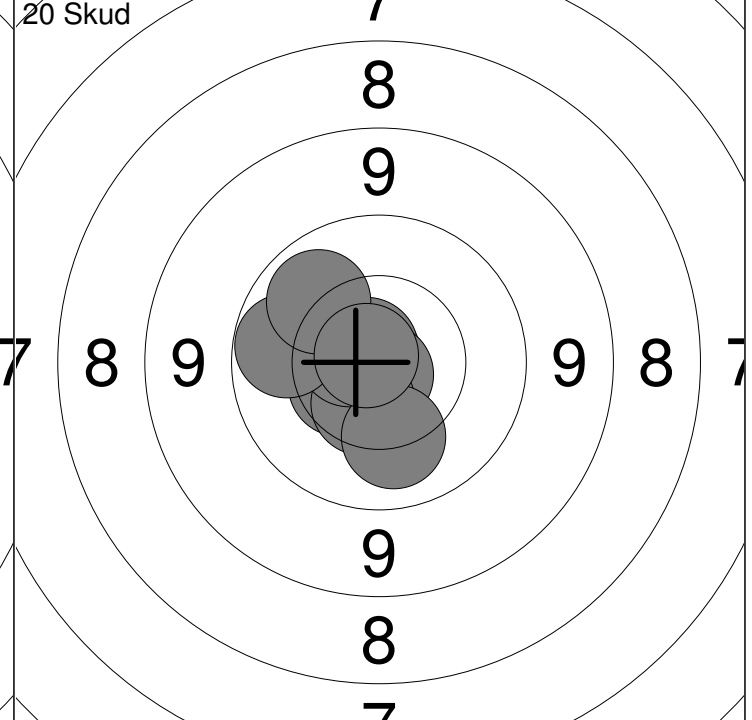
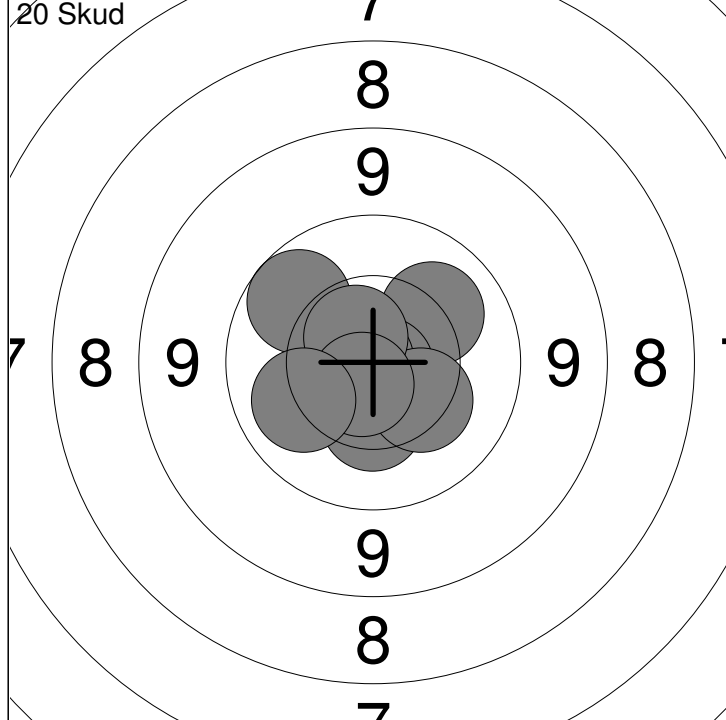

1: 10.2 ↗	6: 10.4 ↓	Serie 99 (5x)
2: 10.6x ↗	7: 10.3 ↓	
3: 9.9 ↗	8: 10.6x ↗	Total 99 (5x)
4: 10.8x ↓	9: 10.7x ↓	
5: 10.8x ←	10: 10.1 ←	

11: 10.8x ↙	16: 10.6x ↙	Serie 100 (5x)
12: 10.8x ↙	17: 10.2 ↓	
13: 10.5 ↙	18: 10.0 ←	Total 199 (10x)
14: 10.8x ↓	19: 10.1 ↗	
15: 10.5 ↓	20: 10.8x ↙	

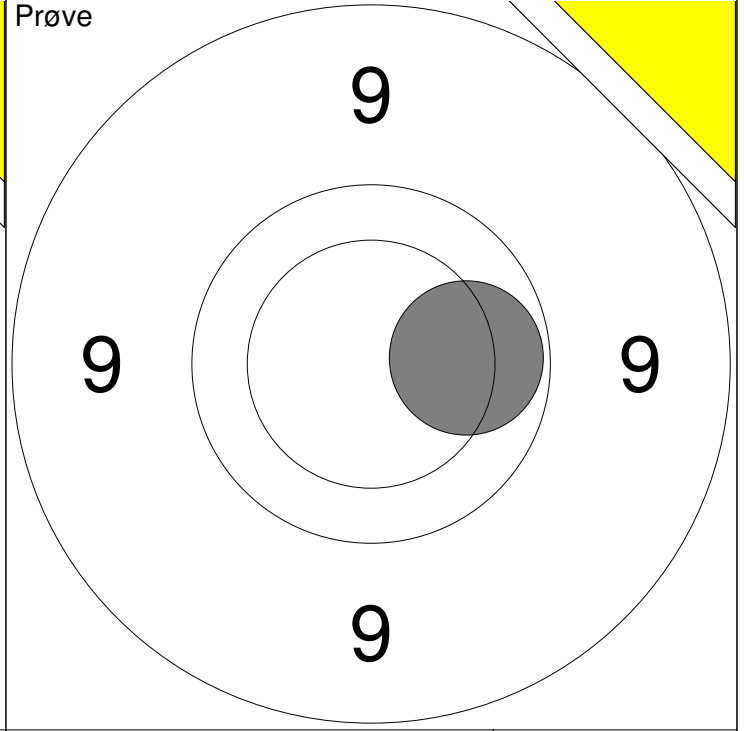
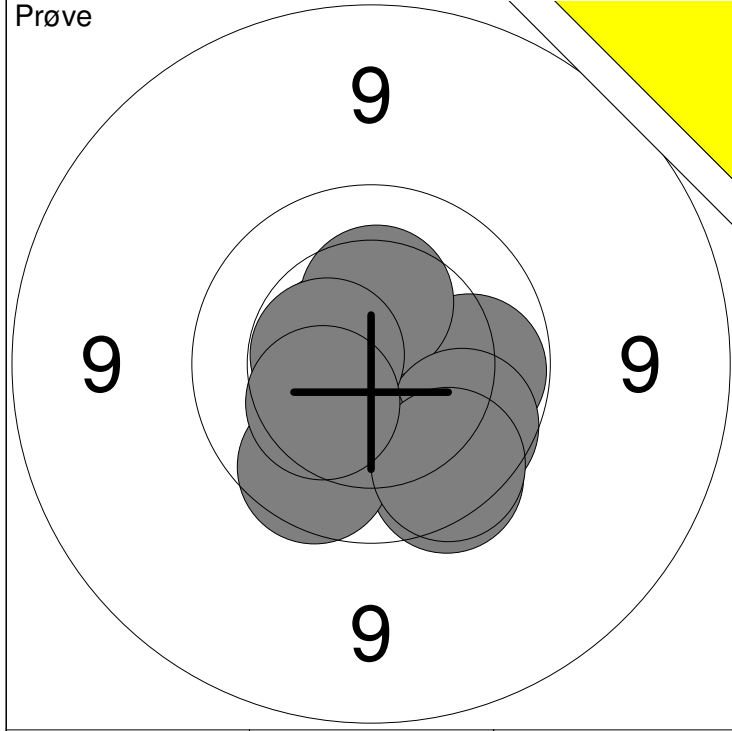

1: 10.0 →	6: 10.2 ↓	Serie	96 (2x)
2: 10.6x ↖	7: 10.5x ←		
3: 10.3 ↑	8: 9.9 ↓	Total	0 (0x)
4: 9.8 ↓	9: 9.8 ↓		
5: 9.9 ↓	10: 10.3 ↙		

11: 10.0 →	Serie	10 (0x)
	Total	0 (0x)

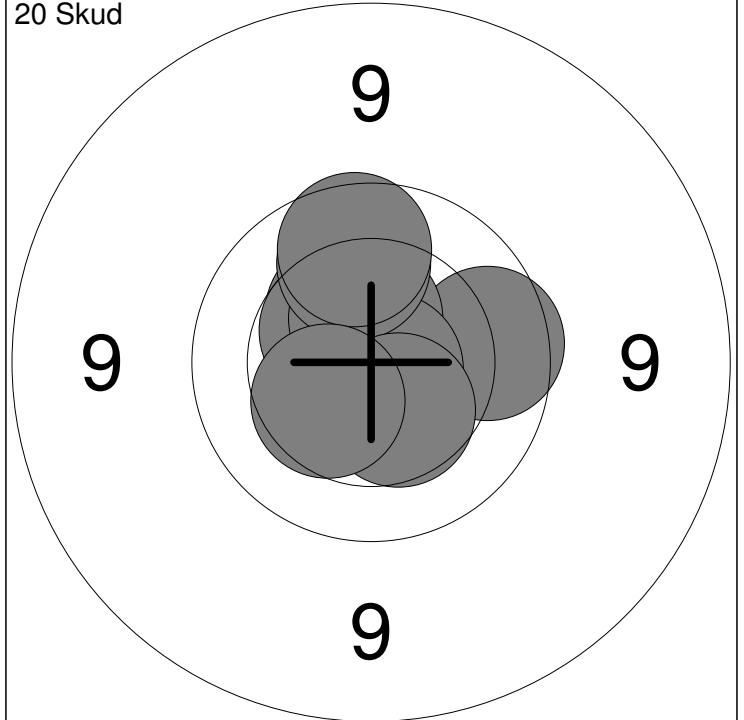
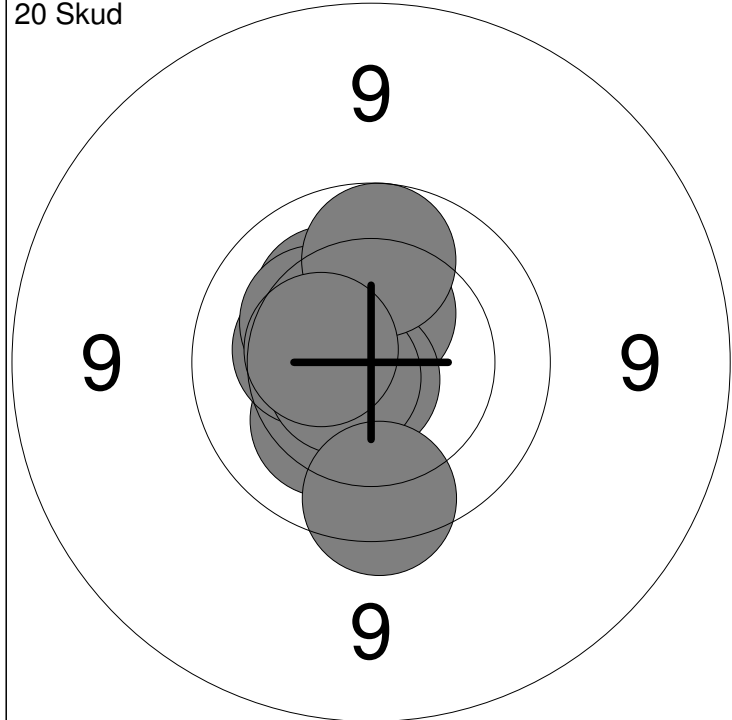

1: 10.2 ↖	6: 10.8x ↓	Serie	98 (2x)
2: 10.2 ↓	7: 10.6x ←		
3: 10.5 ↑	8: 9.9 ↑	Total	98 (2x)
4: 10.3 ←	9: 10.4 ←		
5: 10.3 ↖	10: 9.8 ↓		

11: 9.9 →	16: 10.8x ↘	Serie	98 (3x)
12: 10.4 ↖	17: 10.0 ↑		
13: 10.6x ↓	18: 9.9 ↑	Total	196 (5x)
14: 10.5 ↖	19: 10.4 ↓		
15: 10.5x ↑	20: 10.4 ↙		

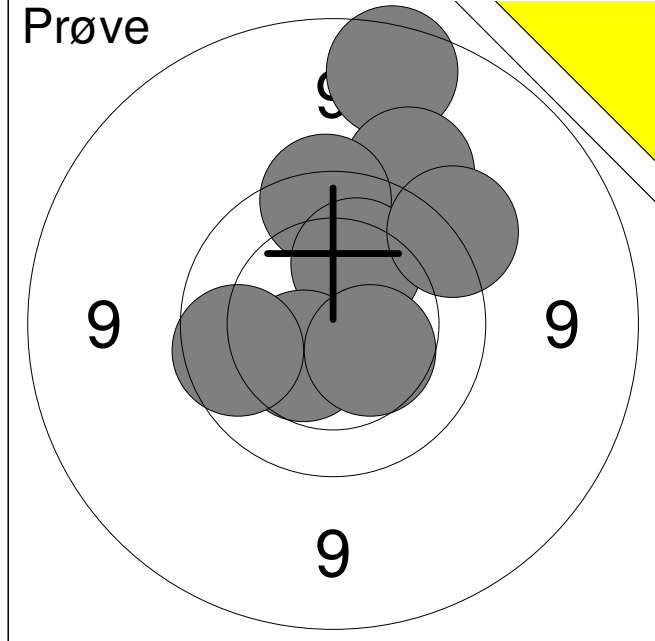

1:	8.9	↑
2:	9.4	↗
3:	9.7	↑
4:	10.2	↗
5:	9.5	↘
6:	10.5	↙
7:	10.4	↘
8:	9.9	←
Serie		74 (0x)
Total		0 (0x)

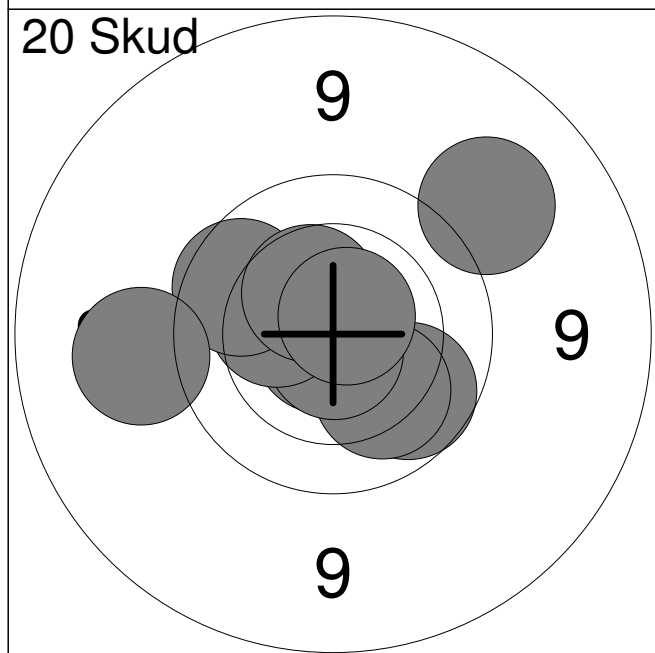

1:	9.9	↘
2:	10.1	↘
3:	9.3	↗
4:	10.8x	↙
5:	10.8x	↓
6:	10.3	←
7:	9.9	↖
8:	10.4	↗
9:	10.7x	↗
10:	9.3	←
Serie		96 (3x)
Total		96 (3x)

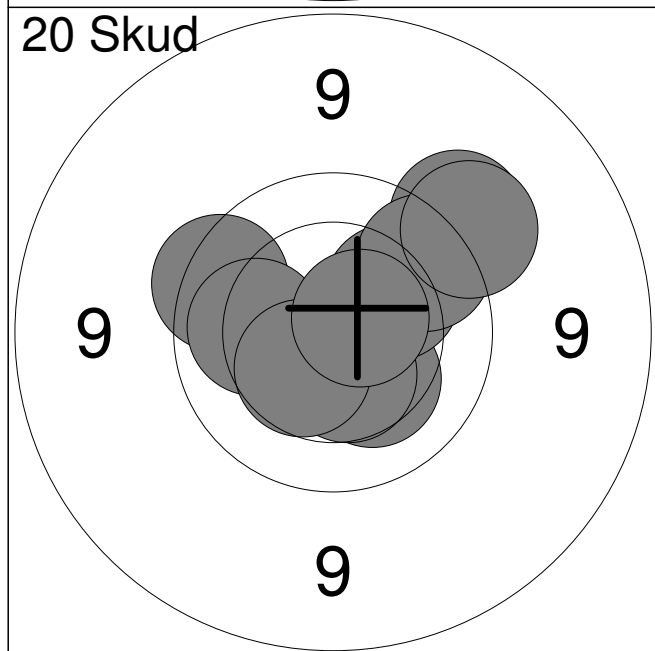

11:	9.7	↖
12:	10.1	←
13:	10.3	↘
14:	10.5	↓
15:	10.4	↙
16:	10.2	↗
17:	9.5	↗
18:	9.8	↗
19:	10.6x	↗
20:	9.4	↗
Serie		96 (1x)
Total		192 (4x)

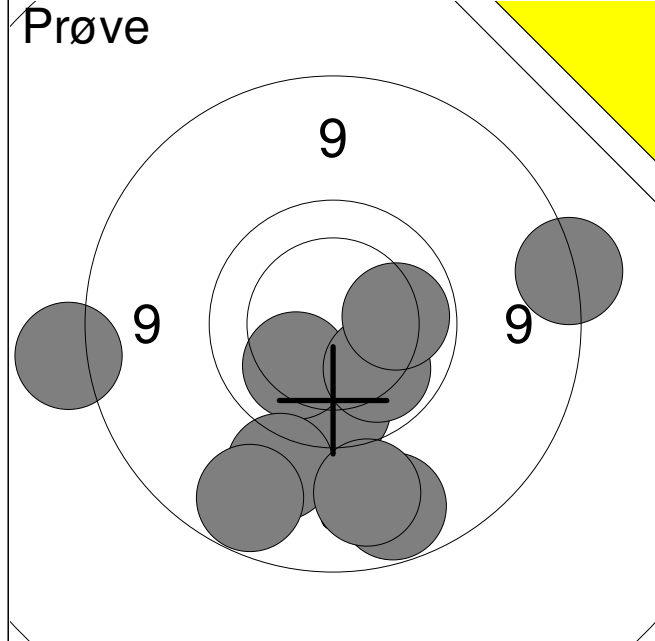

1:	8.7	→
2:	9.8	↓
3:	10.2	↙
4:	9.3	↘
5:	10.1	↘
6:	9.0	↓
7:	9.0	↘
8:	8.6	←
9:	9.1	↓
10:	10.0	→
Serie		91 (0x)
Total		0 (0x)

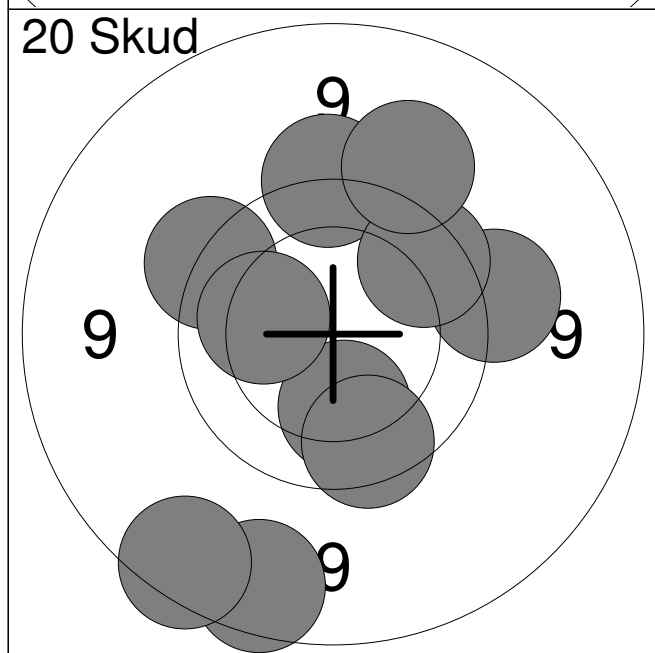

1:	8.9	↓
2:	10.1	↓
3:	9.5	↑
4:	8.8	↘
5:	9.8	↓
6:	9.6	↖
7:	9.5	→
8:	9.8	↗
9:	9.3	↗
10:	10.1	←
Serie		90 (0x)
Total		90 (0x)

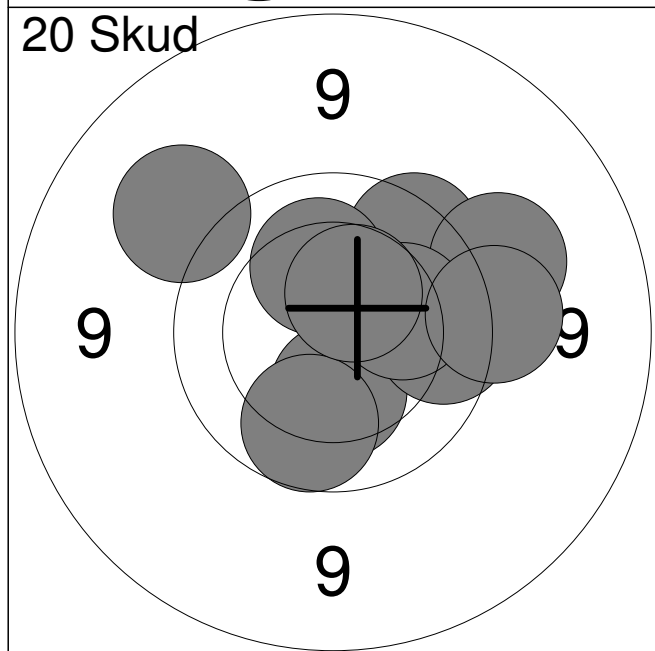

11:	9.3	↖
12:	9.8	↗
13:	10.3	↓
14:	9.4	→
15:	9.8	→
16:	9.9	↓
17:	10.2	↑
18:	10.2	→
19:	10.5	↗
20:	9.5	→
Serie		94 (0x)
Total		184 (0x)

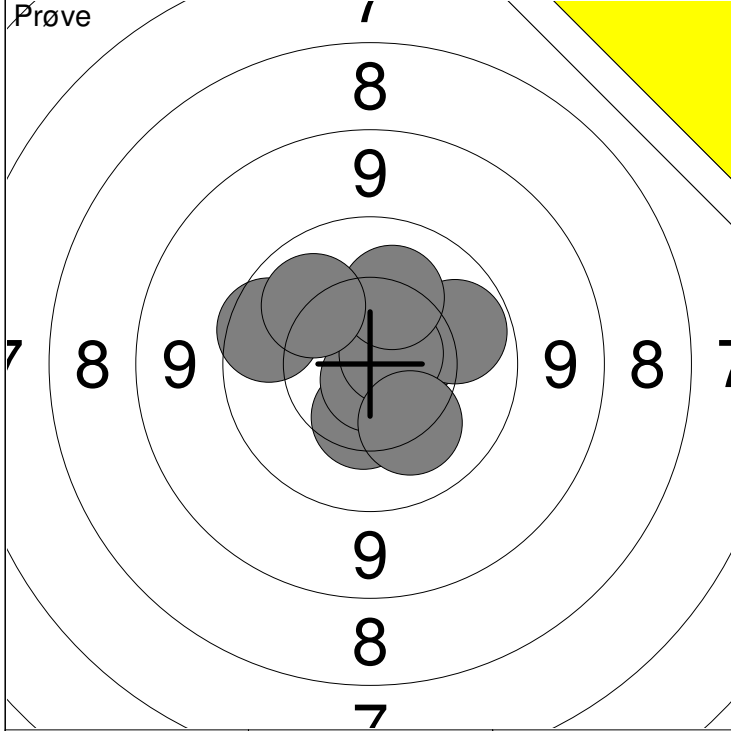

1: 10.4 ↓	6: 10.7x →	Serie	99 (3x)
2: 10.4 →	7: 10.2 ↓		
3: 10.7x ↓	8: 9.8 ←		
4: 10.0 →	9: 10.2 ↑		
5: 10.8x ↓	10: 10.1 ↖		

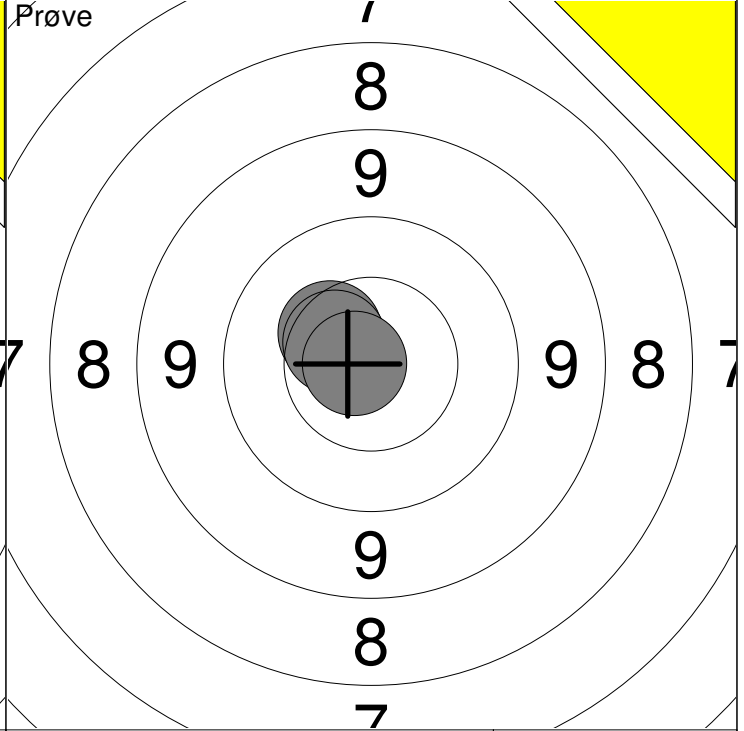

11: 10.4 ↖	Serie	30 (1x)
12: 10.5 ↖		
13: 10.8x ←		

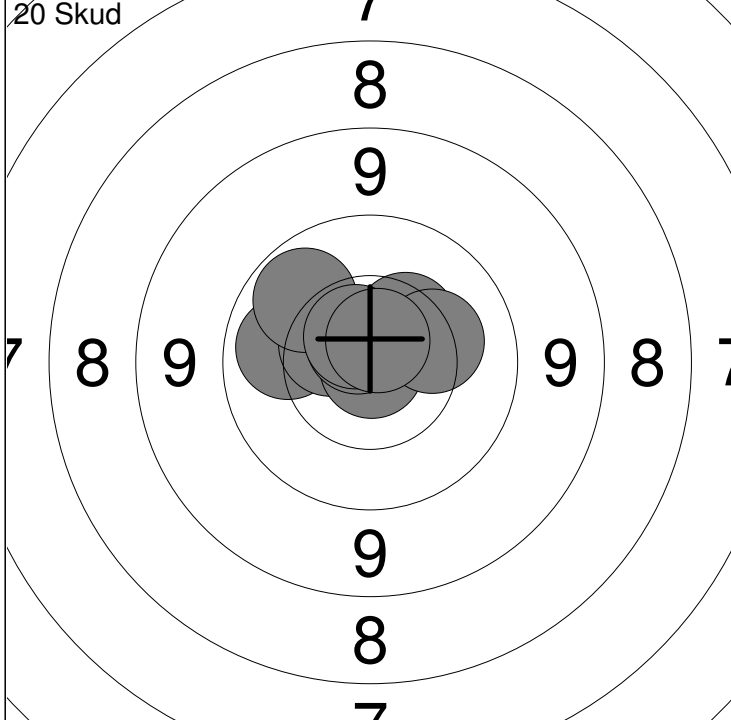

1: 10.8x ↖	6: 10.0 ↖	Serie	100 (5x)
2: 10.1 ←	7: 10.7x ↖		
3: 10.5 ↖	8: 10.3 →		
4: 10.4 ↗	9: 10.6x ↖		
5: 10.9x ↓	10: 10.7x ↑		

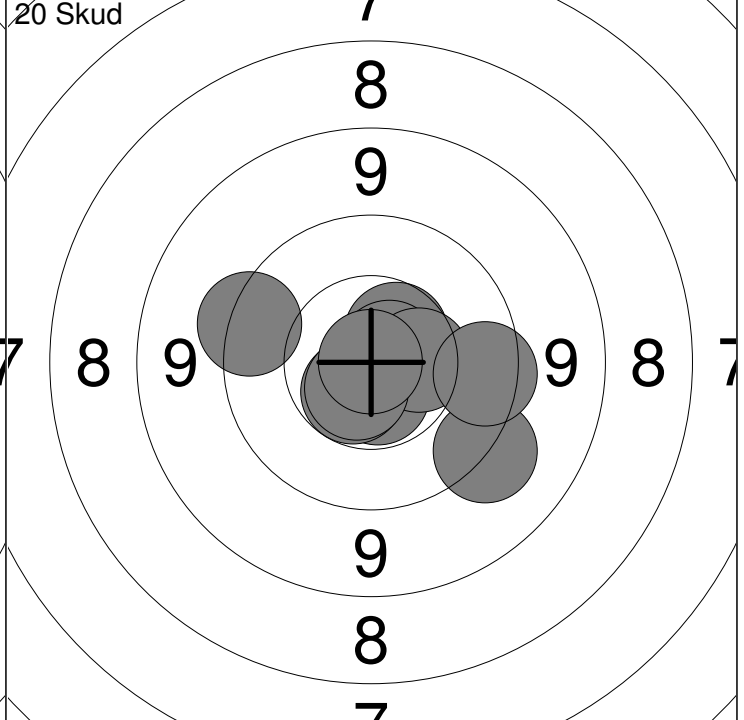

11: 10.6 ↗	16: 10.6x ↓	Serie	97 (5x)
12: 9.4 ↓	17: 9.7 →		
13: 10.6x ↓	18: 9.6 ←		
14: 10.7x ↗	19: 10.6x ↓		
15: 10.5 →	20: 10.9x ↖		

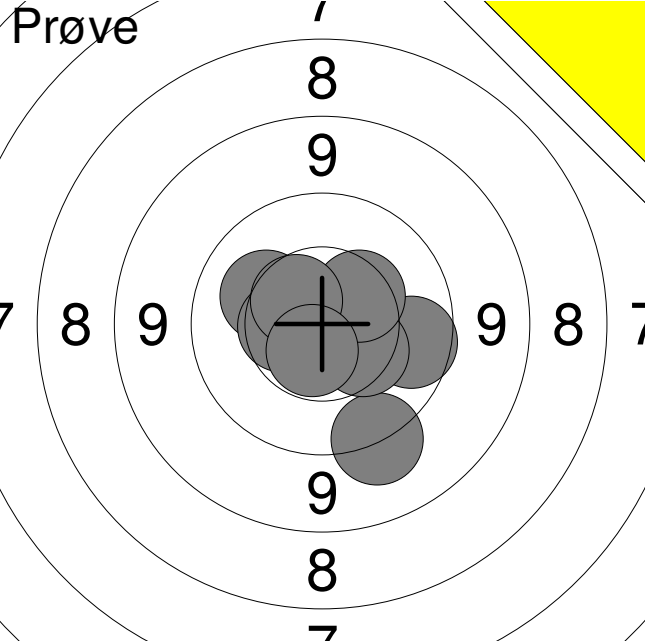
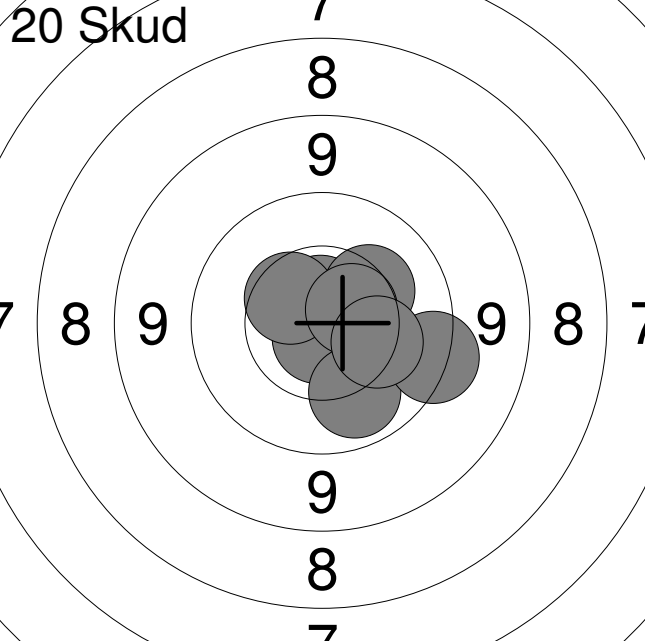
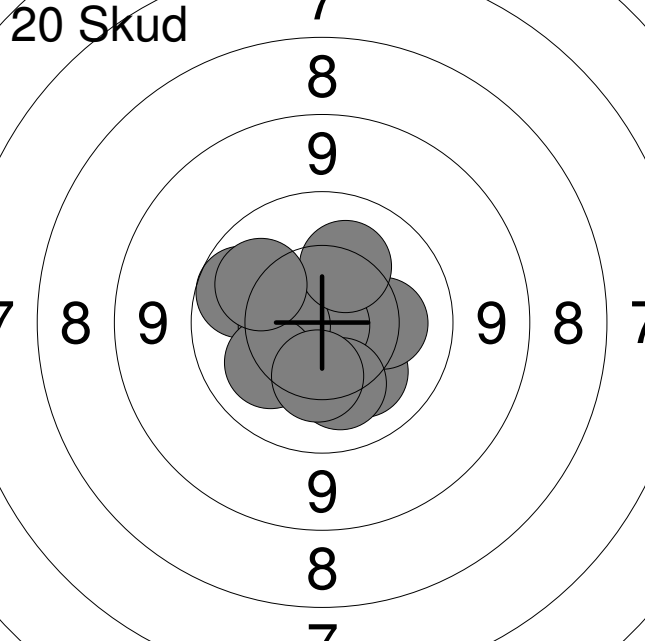
Hold 24	Skive 2	Emma Hejlesen_Kristensen		
15 meter		Vester Hassing Skytteforening		MJ2
		Nordjysk mesterskab 2019	Aalborg Skyttekreds	
Prøve 		1: 10.2 ↗ 2: 10.8x ↗ 3: 10.5 ← 4: 9.4 ↓ 5: 9.9 → 6: 10.4 ↓ 7: 10.4 ↗ 8: 10.5 ↗ 9: 10.6x ↓		
		Serie		88 (2x)
		Total		0 (0x)
20 Skud 		1: 10.6 ↓ 2: 10.6x ↗ 3: 10.7x ↑ 4: 10.3 ↗ 5: 10.8x ↓ 6: 10.1 ↓ 7: 10.5 ↗ 8: 9.5 → 9: 10.6 ↗ 10: 10.3 →		
		Serie		99 (3x)
		Total		99 (3x)
20 Skud 		11: 10.2 ↓ 12: 10.2 → 13: 9.9 ↗ 14: 10.9x ↓ 15: 10.2 ↓ 16: 10.5 ← 17: 10.2 ↗ 18: 10.2 ↗ 19: 10.3 ↓ 20: 10.1 ↗		
		Serie		99 (1x)
		Total		198 (4x)

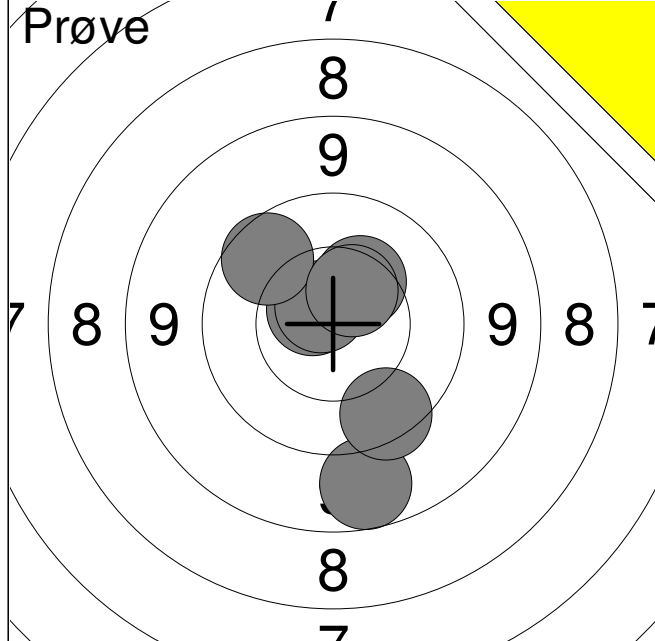

1:	8.9	↓
2:	9.7	↓
3:	10.7x	↗
4:	10.7x	↗
5:	9.8	↗
6:	10.4	↗
7:	10.5	↗
Serie	66 (2x)	
Total	0 (0x)	

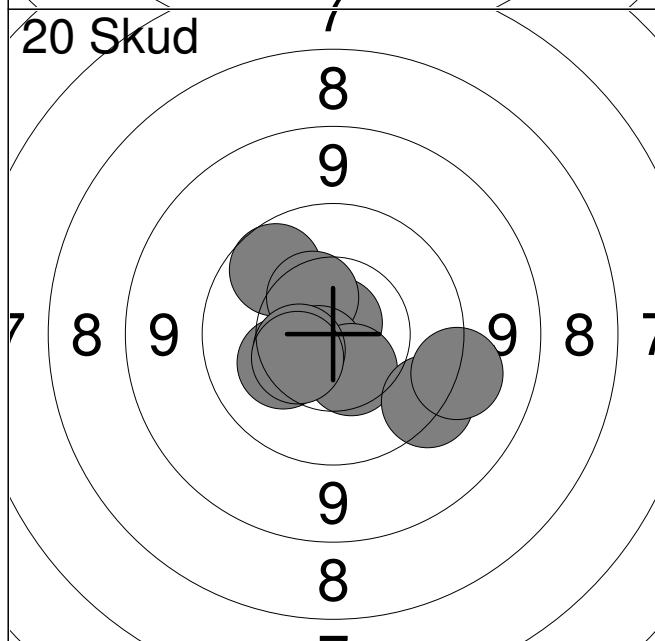

1:	10.8x	↑
2:	10.3	↖
3:	9.9	↗
4:	10.4	↗
5:	10.7x	↘
6:	10.5	↘
7:	10.5	↖
8:	9.5	↘
9:	10.4	↖
10:	9.4	→
Serie	97 (2x)	
Total	97 (2x)	

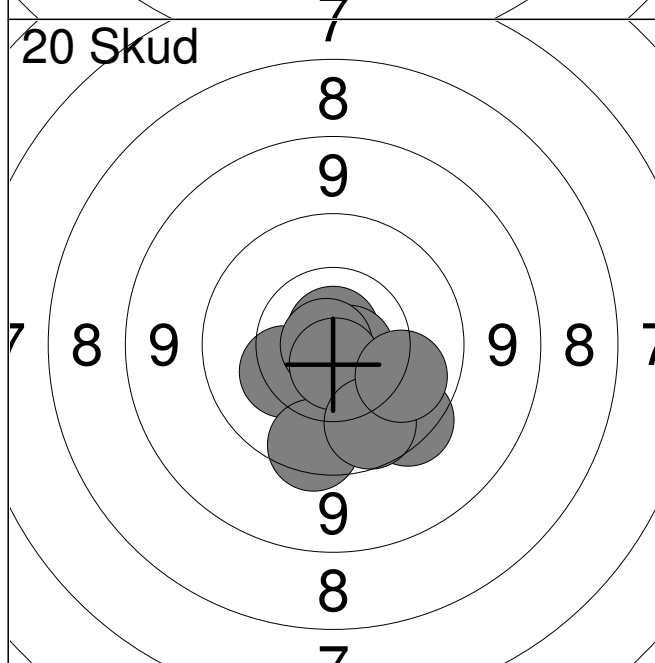

11:	10.3	↖
12:	9.7	↘
13:	10.8x	↑
14:	9.7	↘
15:	10.9x	↘
16:	10.8x	↘
17:	10.9x	↖
18:	10.7x	↘
19:	9.9	↘
20:	10.1	↘
Serie	97 (5x)	
Total	194 (7x)	

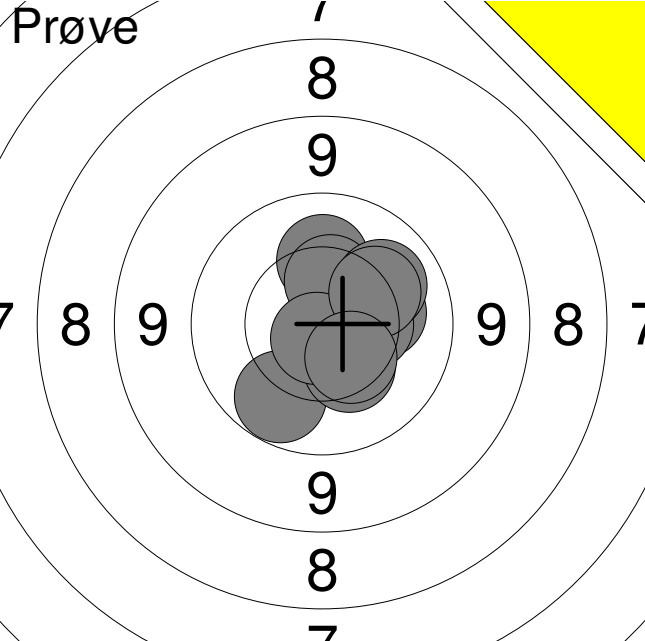
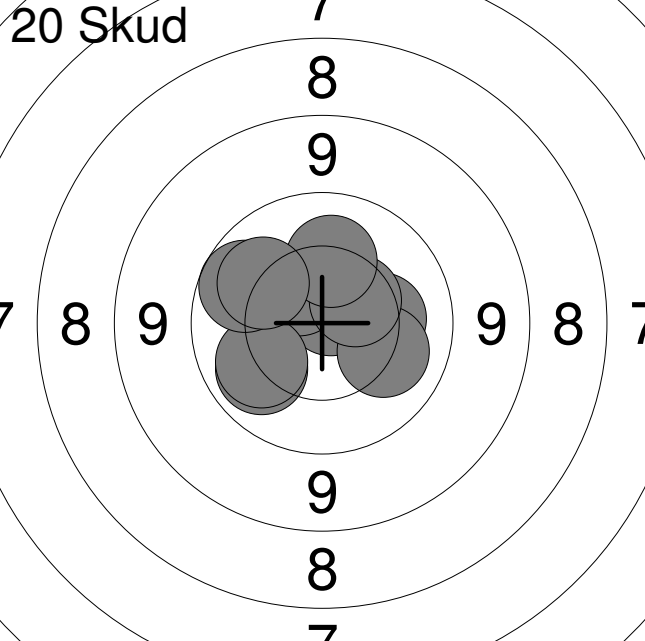
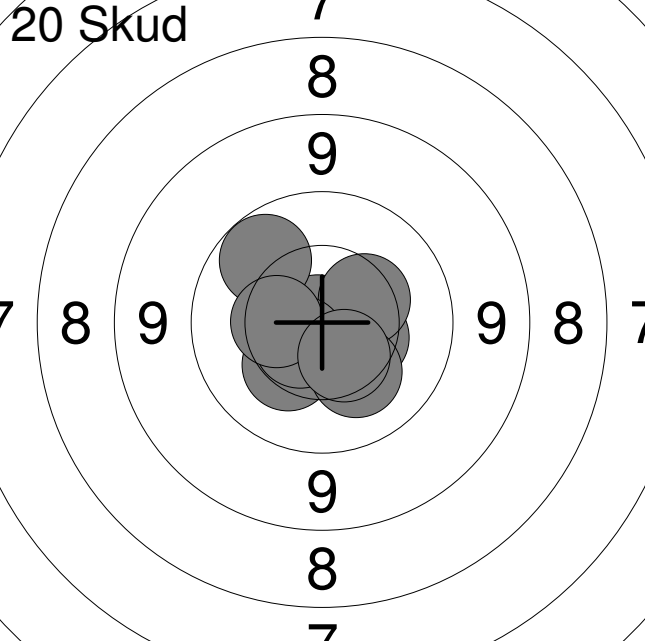
Hold 24	Skive 4	Emil Hedemann	
15 meter		Vester Hassing Skytteforening	MJ2
		Nordjysk mesterskab 2019	Aalborg Skyttekreds
Prøve 	1:	10.0	↙
	2:	10.2	→
	3:	10.4	↘
	4:	10.4	→
	5:	10.2	↑
	6:	10.4	↑
	7:	10.1	↗
	8:	10.8x	↘
	9:	10.2	↗
	10:	10.4	↘
	Serie		100 (1x)
Total		0 (0x)	
20 Skud 	1:	10.3	→
	2:	10.8x	↗
	3:	10.1	↙
	4:	10.2	↘
	5:	10.5	↗
	6:	10.1	↙
	7:	9.9	↖
	8:	10.5	↗
	9:	10.2	↑
	10:	10.1	↖
Serie		99 (1x)	
Total		99 (1x)	
20 Skud 	11:	10.4	→
	12:	10.6x	↘
	13:	10.3	↙
	14:	10.9x	↖
	15:	10.4	↗
	16:	10.6x	↙
	17:	10.0	↗
	18:	10.2	↘
	19:	10.4	←
	20:	10.5	↘
Serie		100 (3x)	
Total		199 (4x)	

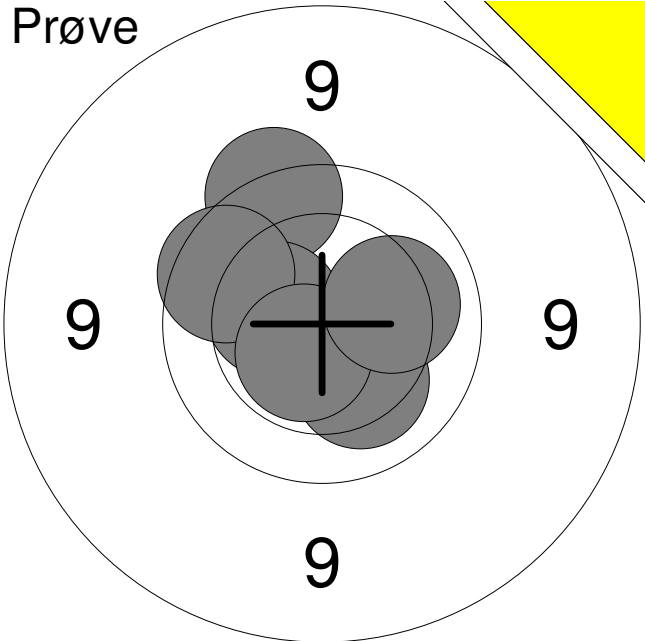
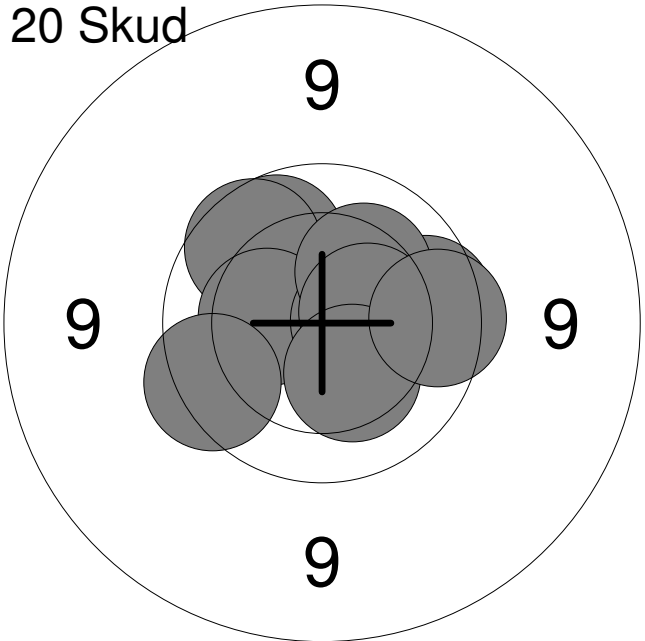
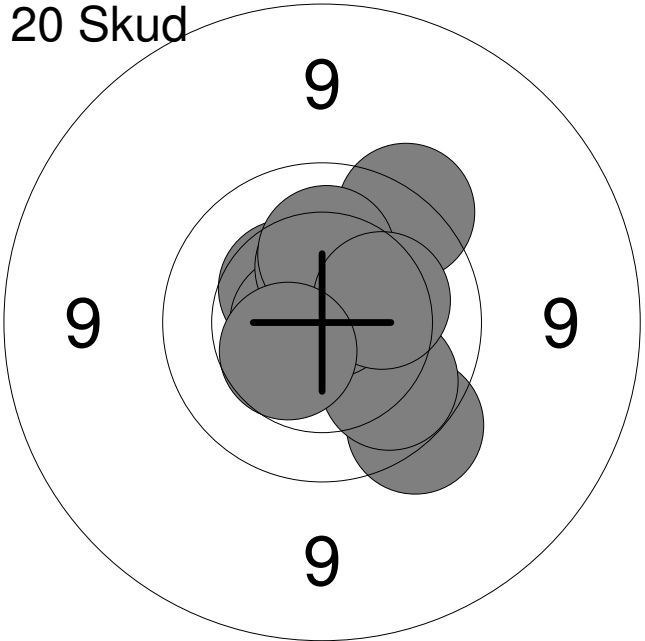
Hold 24	Skive 5	Toke_OEstergaard		
15 meter		Sæby og omegns skytteforening		BK3
		Nordjysk mesterskab 2019	Aalborg Skyttekreds	
Prøve 		1: 9.7 ↗ 2: 10.4 ↖ 3: 9.8 ↗ 4: 10.2 ↘ 5: 10.6x ↘ 6: 10.2 →		
		Serie		58 (1x)
		Total		0 (0x)
20 Skud 		1: 9.9 ↗ 2: 9.9 ↗ 3: 10.3 ↖ 4: 9.9 → 5: 10.5x → 6: 10.2 ↗ 7: 10.4 → 8: 10.3 ↘ 9: 9.8 → 10: 9.7 ↖		
		Serie		95 (1x)
		Total		95 (1x)
20 Skud 		11: 9.6 ↘ 12: 10.4 ↗ 13: 10.0 ↘ 14: 10.8x ↗ 15: 10.7x ↖ 16: 10.3 ↑ 17: 9.6 ↗ 18: 10.2 ↑ 19: 10.2 → 20: 10.5 ↘		
		Serie		98 (2x)
		Total		193 (3x)

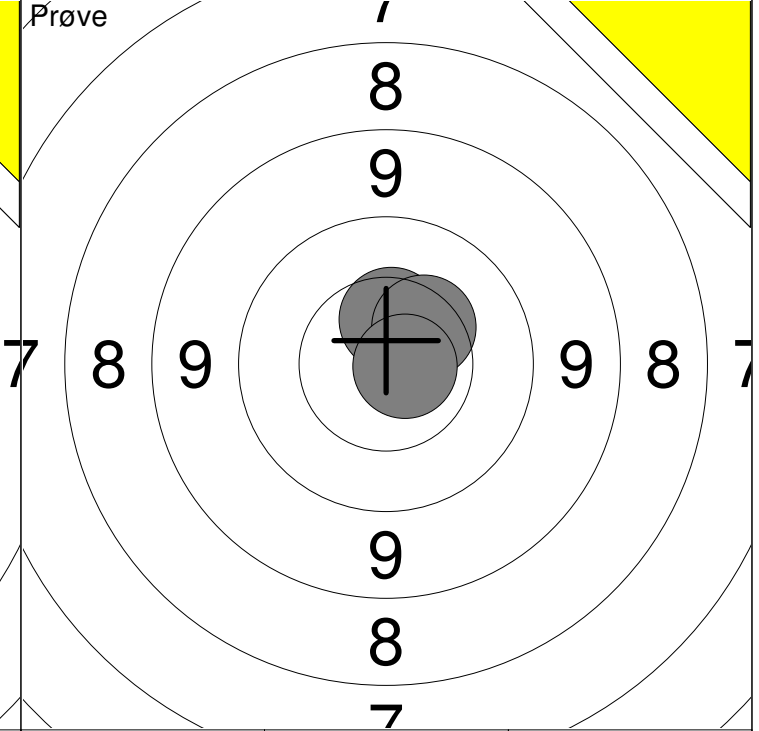
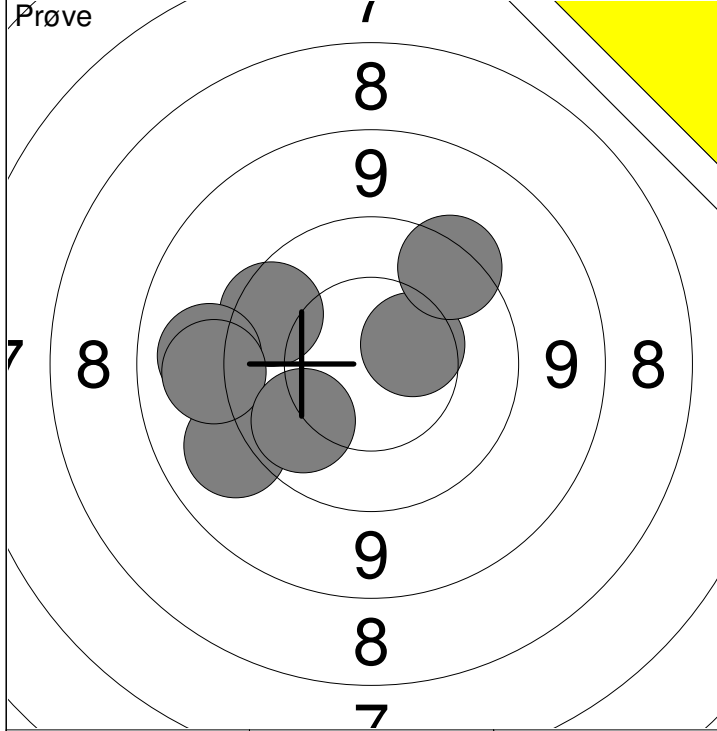

1: 9.2 ↙	7: 10.0 ↙	Serie 65 (0x)
2: 9.8 ↖	9: 9.6 ↗	
3: 9.2 ←		Total 0 (0x)
4: 9.2 ←		
5: 10.5 →		

12: 10.5 ↑	Serie 30 (1x)
14: 10.4 ↗	
16: 10.7x →	Total 0 (0x)

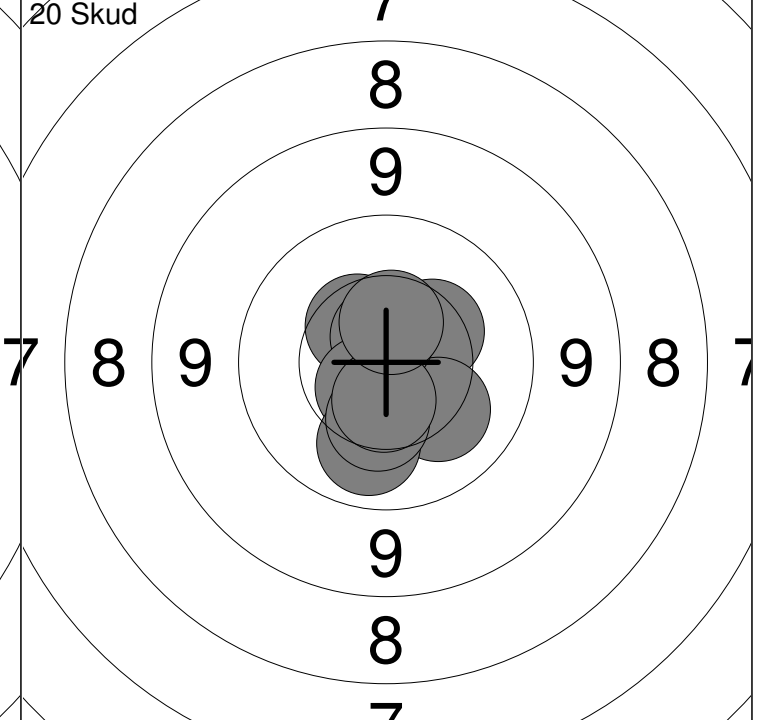
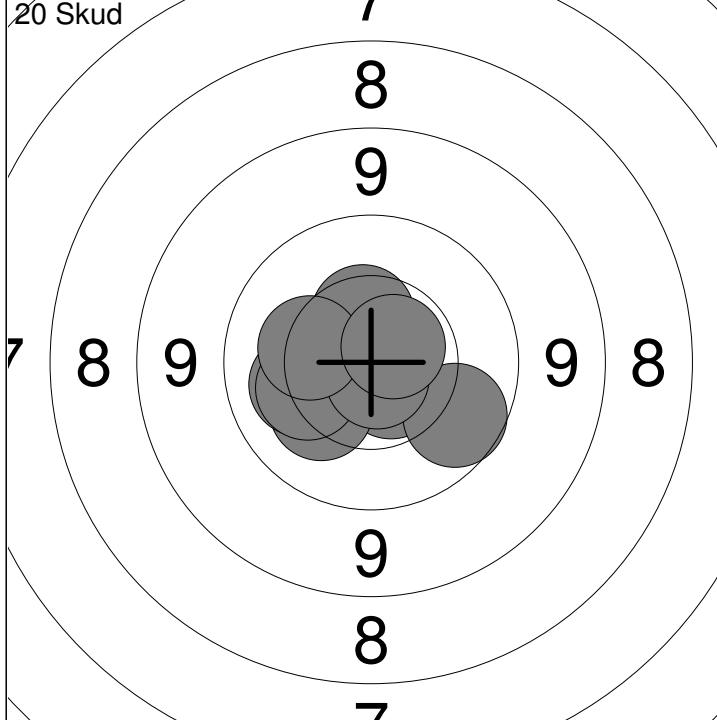

1: 10.9x ↓	6: 10.5 ↑	Serie 99 (4x)
2: 10.6x ↓	7: 10.2 ←	
3: 10.2 ↙	8: 10.8x ↓	Total 99 (4x)
4: 9.9 ↘	9: 10.3 ←	
5: 10.2 ←	10: 10.7x ↗	

11: 10.7x ↖	16: 10.6x ↙	Serie 100 (3x)
12: 10.5 ↖	17: 10.1 ↓	
13: 10.4 ↗	18: 10.3 ↓	Total 199 (7x)
14: 10.2 ↘	19: 10.6 ↓	
15: 10.7x ↑	20: 10.5 ↑	

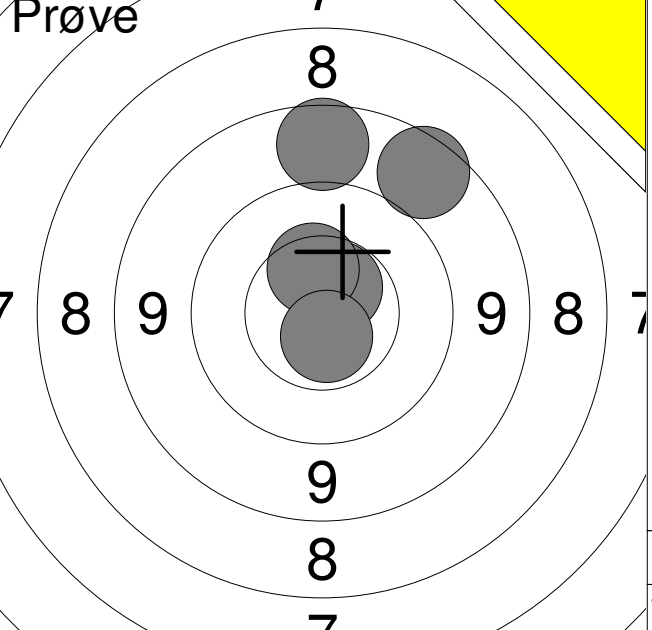
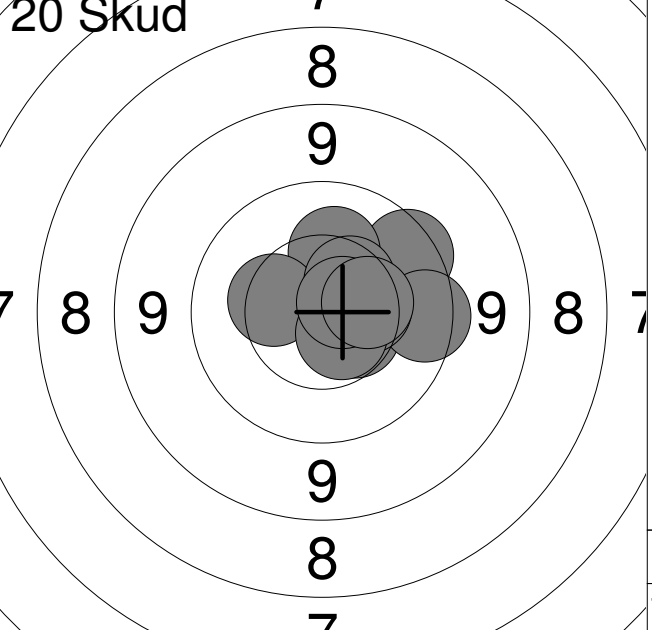
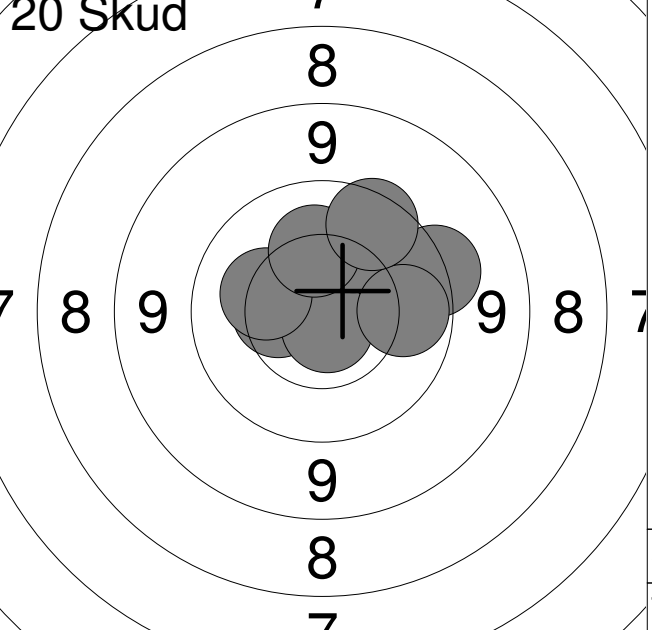
	Nordjysk mesterskab 2019	Aalborg Skyttekreds																														
Prøve 	<table style="width:100%; border-collapse: collapse;"> <tr><td style="width:10%;">1:</td><td style="width:10%;">8.8</td><td style="width:10%; text-align: right;">↗</td></tr> <tr><td>3:</td><td>8.9</td><td style="text-align: right;">↑</td></tr> <tr><td>5:</td><td>10.6x</td><td style="text-align: right;">↗</td></tr> <tr><td>6:</td><td>10.4</td><td style="text-align: right;">↑</td></tr> <tr><td>7:</td><td>10.7x</td><td style="text-align: right;">↓</td></tr> </table>	1:	8.8	↗	3:	8.9	↑	5:	10.6x	↗	6:	10.4	↑	7:	10.7x	↓																
1:	8.8	↗																														
3:	8.9	↑																														
5:	10.6x	↗																														
6:	10.4	↑																														
7:	10.7x	↓																														
	Serie	46 (2x)																														
	Total	0 (0x)																														
20 Skud 	<table style="width:100%; border-collapse: collapse;"> <tr><td style="width:10%;">1:</td><td style="width:10%;">9.7</td><td style="width:10%; text-align: right;">↗</td></tr> <tr><td>2:</td><td>10.2</td><td style="text-align: right;">↑</td></tr> <tr><td>3:</td><td>10.5</td><td style="text-align: right;">↘</td></tr> <tr><td>4:</td><td>10.4</td><td style="text-align: right;">←</td></tr> <tr><td>5:</td><td>9.7</td><td style="text-align: right;">→</td></tr> <tr><td>6:</td><td>10.4</td><td style="text-align: right;">→</td></tr> <tr><td>7:</td><td>10.6x</td><td style="text-align: right;">↘</td></tr> <tr><td>8:</td><td>10.5</td><td style="text-align: right;">↗</td></tr> <tr><td>9:</td><td>10.7x</td><td style="text-align: right;">↗</td></tr> <tr><td>10:</td><td>10.4</td><td style="text-align: right;">→</td></tr> </table>	1:	9.7	↗	2:	10.2	↑	3:	10.5	↘	4:	10.4	←	5:	9.7	→	6:	10.4	→	7:	10.6x	↘	8:	10.5	↗	9:	10.7x	↗	10:	10.4	→	
1:	9.7	↗																														
2:	10.2	↑																														
3:	10.5	↘																														
4:	10.4	←																														
5:	9.7	→																														
6:	10.4	→																														
7:	10.6x	↘																														
8:	10.5	↗																														
9:	10.7x	↗																														
10:	10.4	→																														
	Serie	98 (2x)																														
	Total	98 (2x)																														
20 Skud 	<table style="width:100%; border-collapse: collapse;"> <tr><td style="width:10%;">11:</td><td style="width:10%;">10.1</td><td style="width:10%; text-align: right;">↗</td></tr> <tr><td>12:</td><td>9.5</td><td style="text-align: right;">→</td></tr> <tr><td>13:</td><td>10.9x</td><td style="text-align: right;">↘</td></tr> <tr><td>14:</td><td>10.4</td><td style="text-align: right;">←</td></tr> <tr><td>15:</td><td>10.8x</td><td style="text-align: right;">↓</td></tr> <tr><td>16:</td><td>10.1</td><td style="text-align: right;">↗</td></tr> <tr><td>17:</td><td>10.3</td><td style="text-align: right;">←</td></tr> <tr><td>18:</td><td>10.0</td><td style="text-align: right;">→</td></tr> <tr><td>19:</td><td>10.2</td><td style="text-align: right;">↑</td></tr> <tr><td>20:</td><td>9.7</td><td style="text-align: right;">↗</td></tr> </table>	11:	10.1	↗	12:	9.5	→	13:	10.9x	↘	14:	10.4	←	15:	10.8x	↓	16:	10.1	↗	17:	10.3	←	18:	10.0	→	19:	10.2	↑	20:	9.7	↗	
11:	10.1	↗																														
12:	9.5	→																														
13:	10.9x	↘																														
14:	10.4	←																														
15:	10.8x	↓																														
16:	10.1	↗																														
17:	10.3	←																														
18:	10.0	→																														
19:	10.2	↑																														
20:	9.7	↗																														
	Serie	98 (2x)																														
	Total	196 (4x)																														

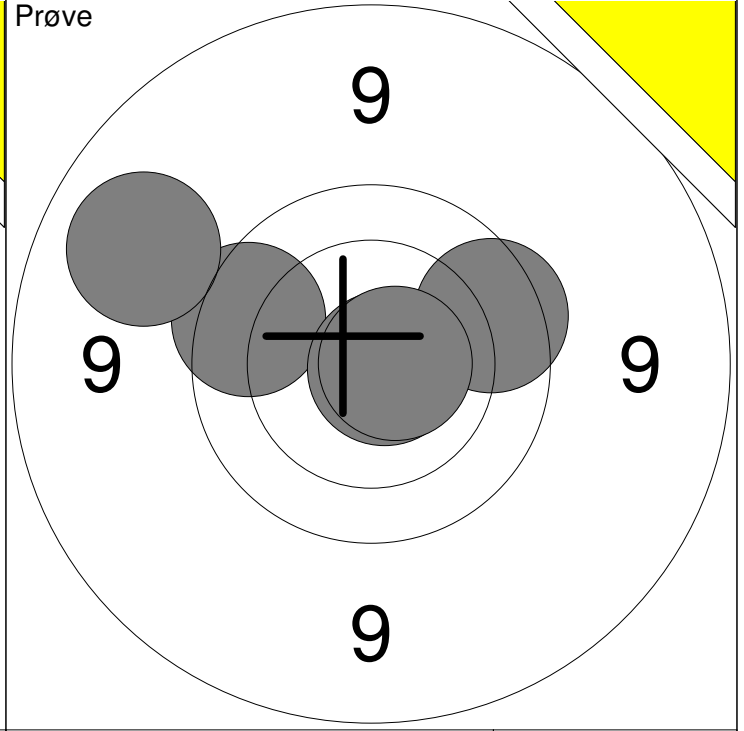
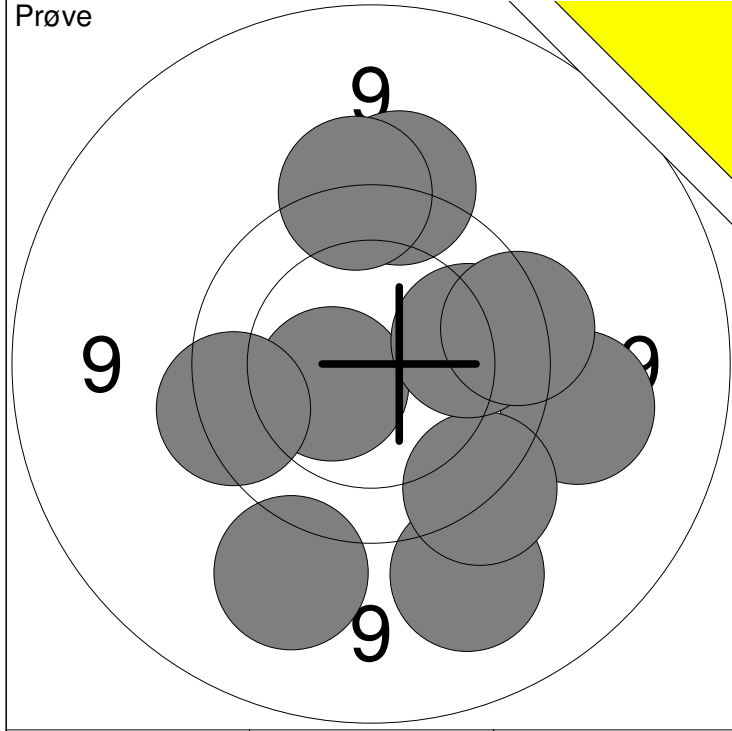

1: 9.3 →	6: 10.5x ←	Serie	92 (1x)
2: 9.2 ↓	7: 9.3 ↓		
3: 9.6 ↓	8: 10.0 →	Total	0 (0x)
4: 9.5 ↑	9: 9.7 ←		
5: 9.6 ↑	10: 9.7 →		

11: 9.8 →	Serie	47 (2x)
12: 9.8 ←		
13: 10.8x →	Total	0 (0x)
14: 9.1 ↖		
15: 10.7x →		

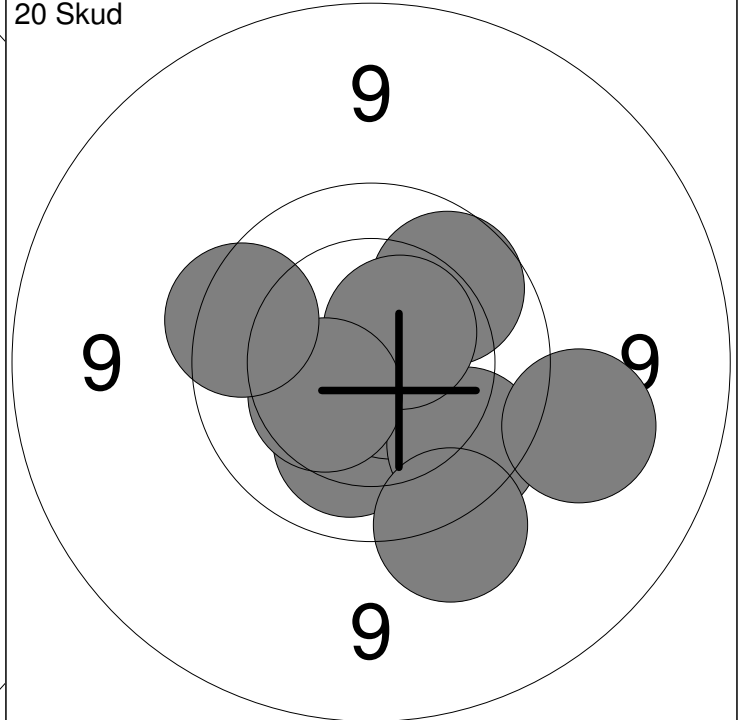
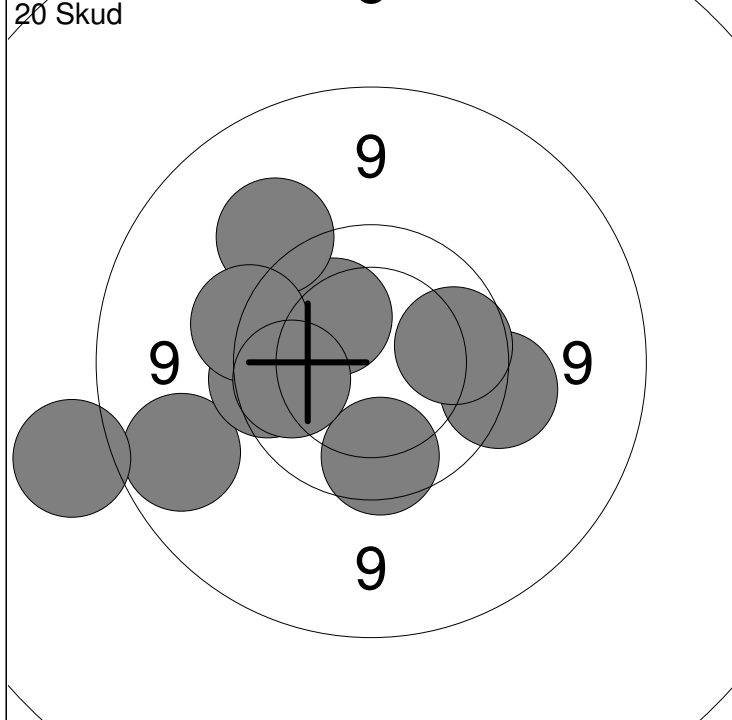

1: 9.0 ←	6: 9.4 ↗	Serie	90 (0x)
2: 9.8 ←	7: 9.6 ←		
3: 9.8 ↓	8: 9.6 →	Total	90 (0x)
4: 10.2 ↗	9: 9.9 ←		
5: 8.5 ←	10: 9.9 →		

11: 10.6x ↓	16: 10.5x ↗	Serie	95 (3x)
12: 10.2 ↓	17: 9.5 ↓		
13: 9.9 ↗	18: 9.3 →	Total	185 (3x)
14: 10.7x ↓	19: 10.4 ←		
15: 9.8 ↓	20: 9.8 ←		

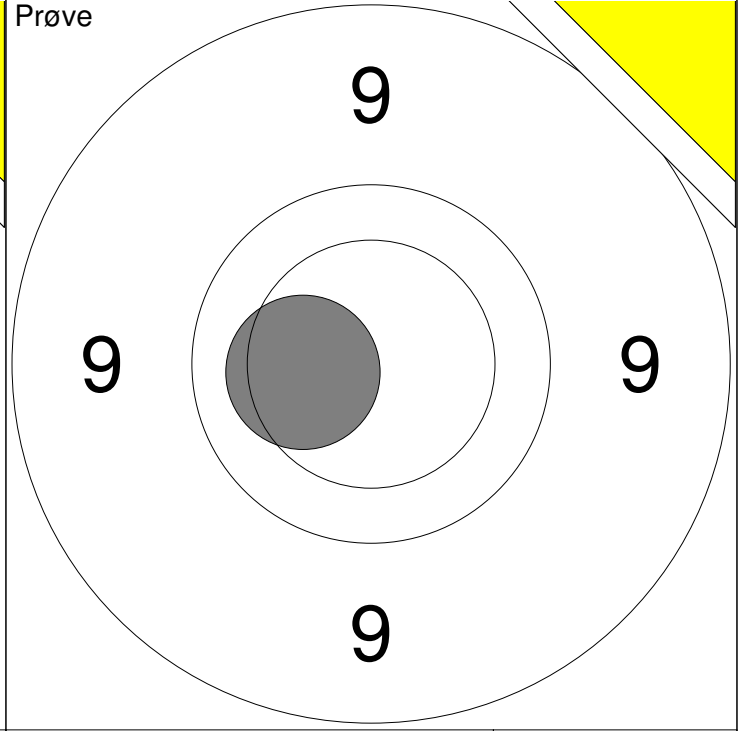
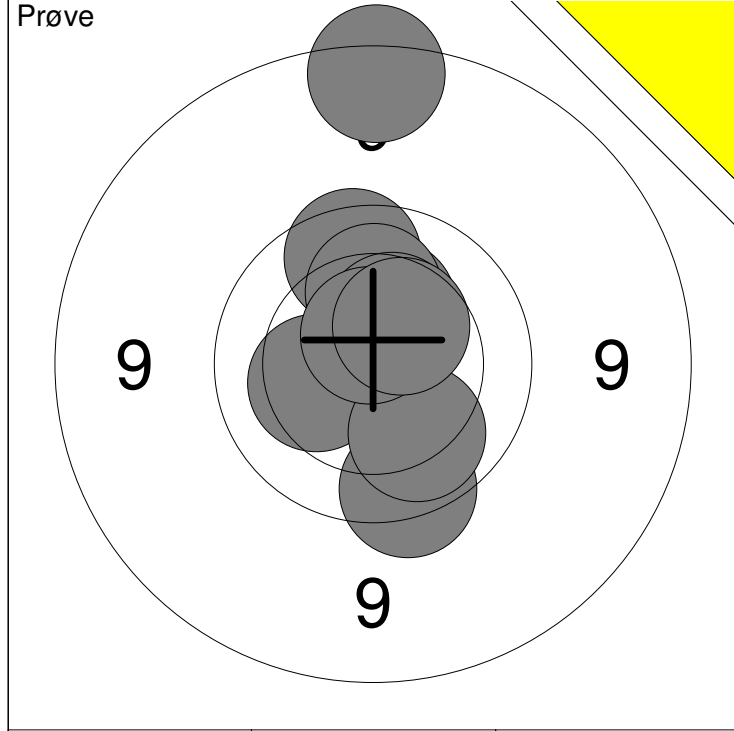

1: 8.8 ↑	6: 10.3 ←	Serie 96 (1x)
2: 10.3 ↑	7: 9.7 ↓	
3: 9.8 ↑	8: 10.1 ↓	Total 0 (0x)
4: 10.2 ↑	9: 10.6x ↑	
5: 10.4 ↗	10: 10.4 ↗	

11: 10.3 ←	Serie 10 (0x)
	Total 0 (0x)

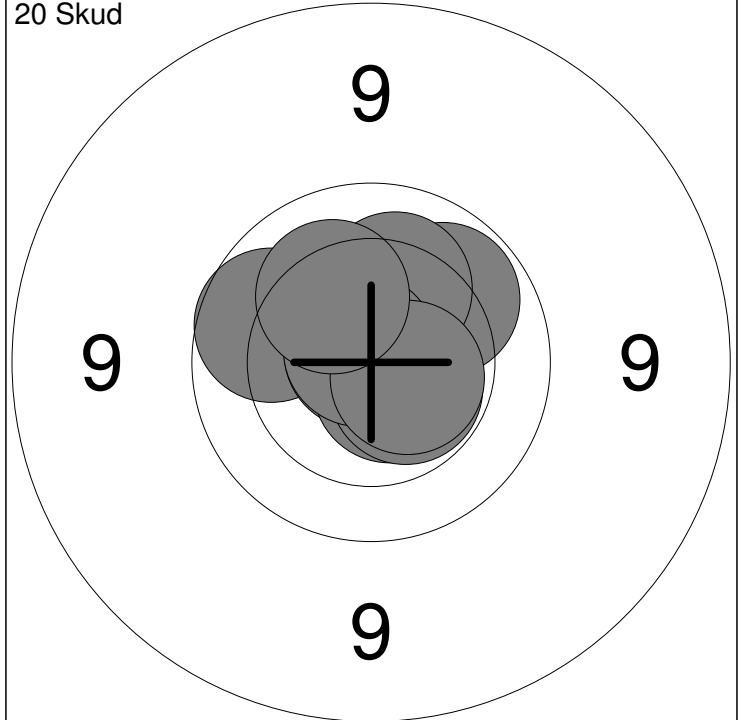
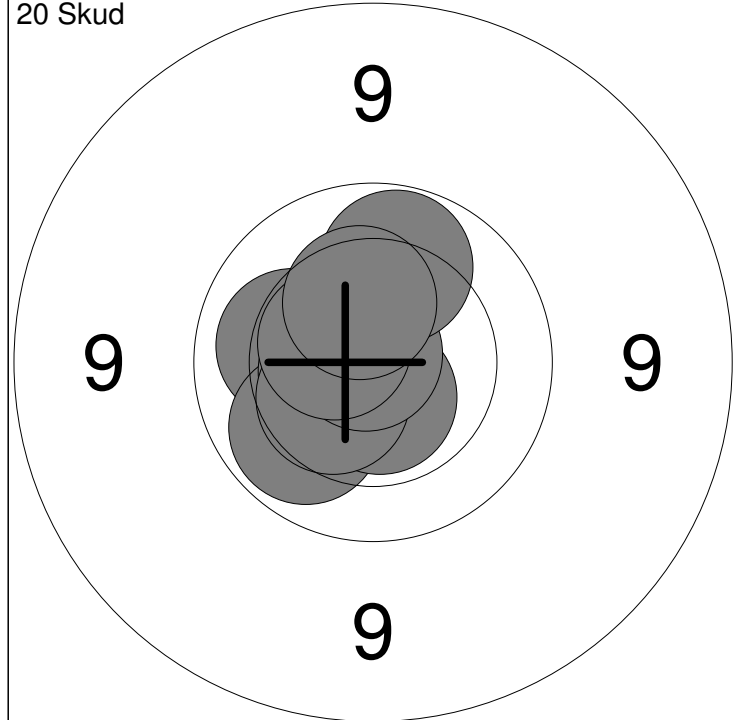

1: 10.6x ↗	6: 10.4 ←	Serie 100 (5x)
2: 10.1 ←	7: 10.8x ↗	
3: 10.0 ↙	8: 10.5x ↙	Total 100 (5x)
4: 10.6x ↓	9: 10.0 ↑	
5: 10.6x ←	10: 10.4 ↑	

11: 9.9 ←	16: 10.5x ↘	Serie 99 (6x)
12: 10.8x ↗	17: 10.2 ↑	
13: 10.0 ↗	18: 10.8x ↗	Total 199 (11x)
14: 10.8x ↘	19: 10.6x ↘	
15: 10.7x ↘	20: 10.2 ↗	

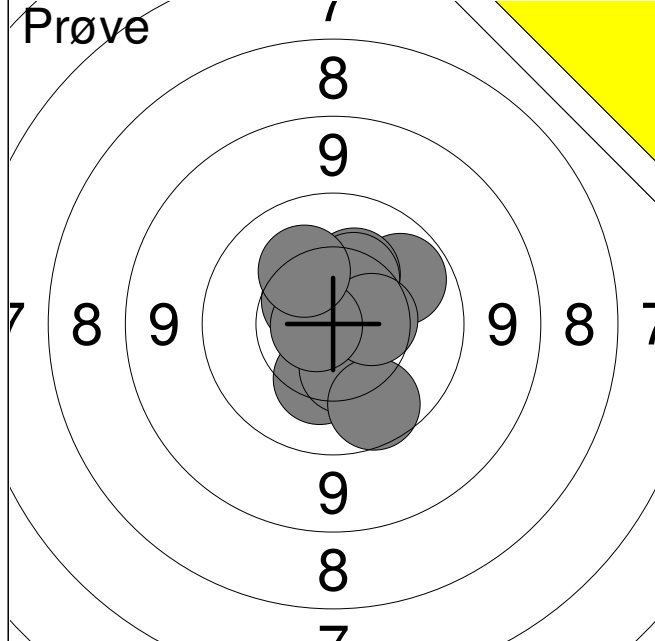

1:	10.0	↗
2:	10.3	↑
3:	10.4	↑
4:	10.3	↓
5:	10.4	↓
6:	10.5	↗
7:	9.9	↓
8:	10.5	→
9:	10.8x	←
10:	10.2	↑
Serie		99 (1x)
Total		0 (0x)

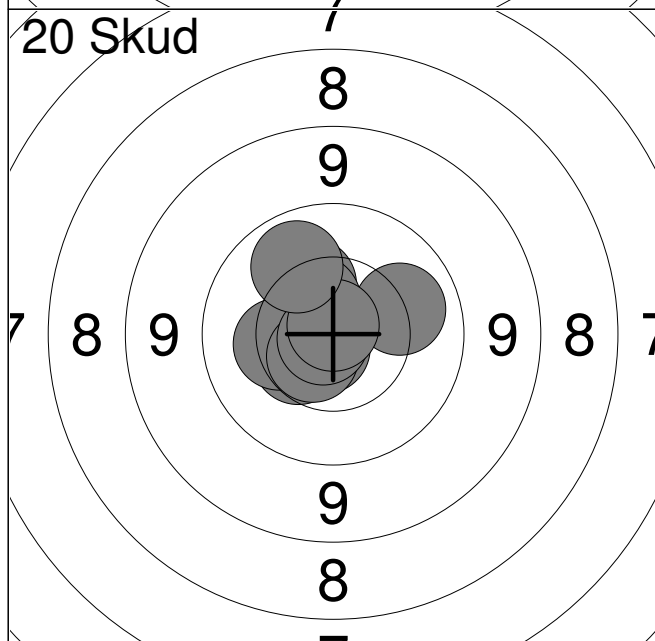

1:	10.1	↗
2:	10.4	↖
3:	10.8x	↘
4:	10.3	↑
5:	10.5	↑
6:	10.3	←
7:	10.6x	↘
8:	10.8x	↖
9:	10.8x	↑
10:	10.0	↑
Serie		100 (4x)
Total		100 (4x)

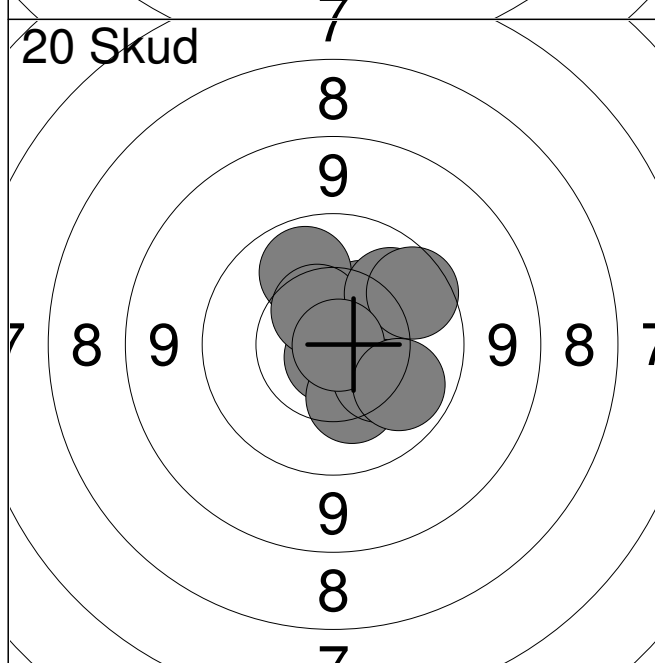

11:	10.8x	↓
12:	10.4	↗
13:	10.3	↓
14:	10.3	↘
15:	10.0	↑
16:	10.5	↑
17:	10.0	↗
18:	9.8	↗
19:	10.9x	→
20:	10.0	↘
Serie		99 (2x)
Total		199 (6x)

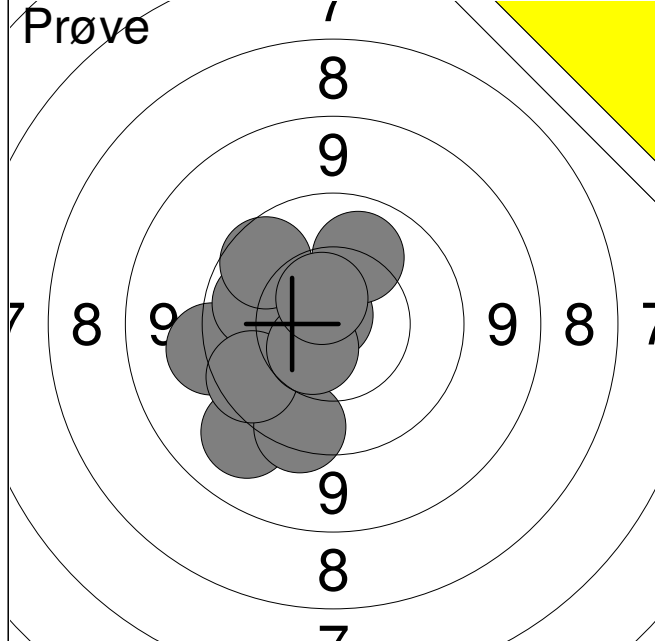

1:	9.4	←
2:	9.3	↙
3:	9.6	↘
4:	10.0	←
5:	9.8	↙
6:	10.8x	↗
7:	10.6	↘
8:	9.9	↗
9:	10.1	↗
10:	10.6x	↗
Serie		95 (2x)
Total		0 (0x)

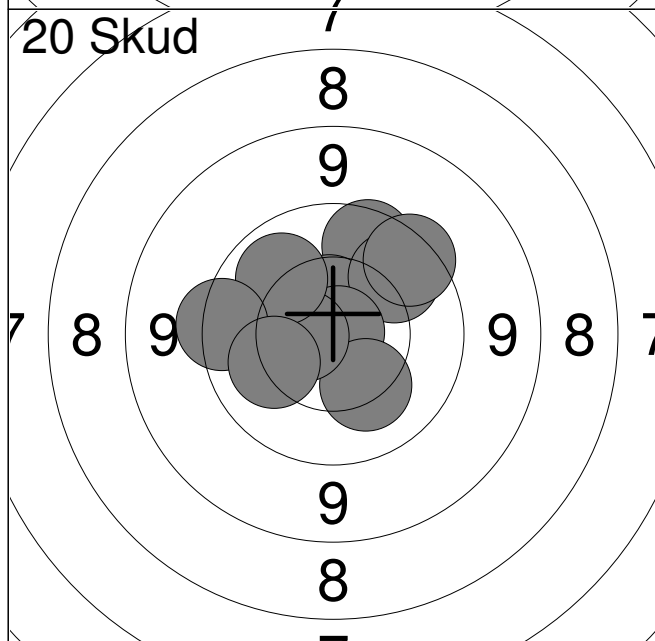

1:	9.8	↗
2:	10.6	↑
3:	10.0	↗
4:	10.9x	→
5:	10.2	↘
6:	10.6x	←
7:	10.1	↗
8:	9.6	←
9:	9.7	↗
10:	10.2	←
Serie		97 (2x)
Total		97 (2x)

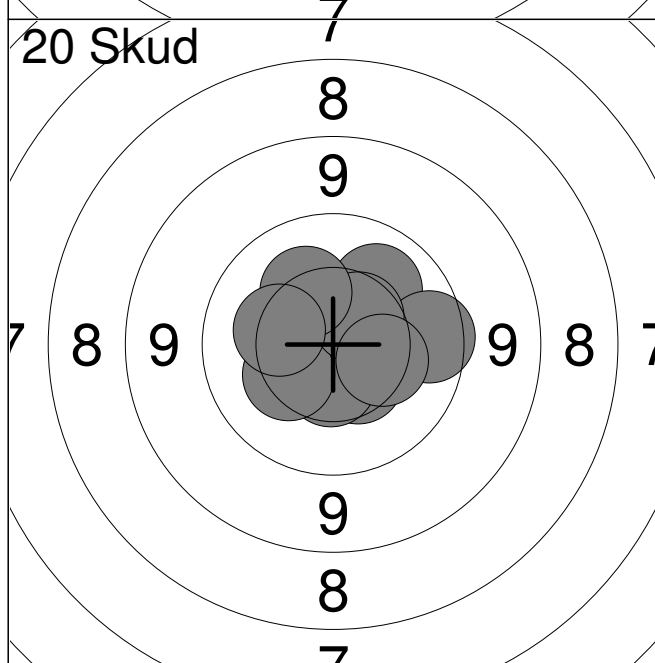

11:	10.1	↗
12:	10.5	↘
13:	10.7x	↘
14:	10.5	↘
15:	10.3	↙
16:	9.8	→
17:	10.5	↗
18:	10.3	↗
19:	10.3	←
20:	10.3	→
Serie		99 (1x)
Total		196 (3x)

	Nordjysk mesterskab 2019	Aalborg Skyttekreds
--	--------------------------	---------------------

Prøve

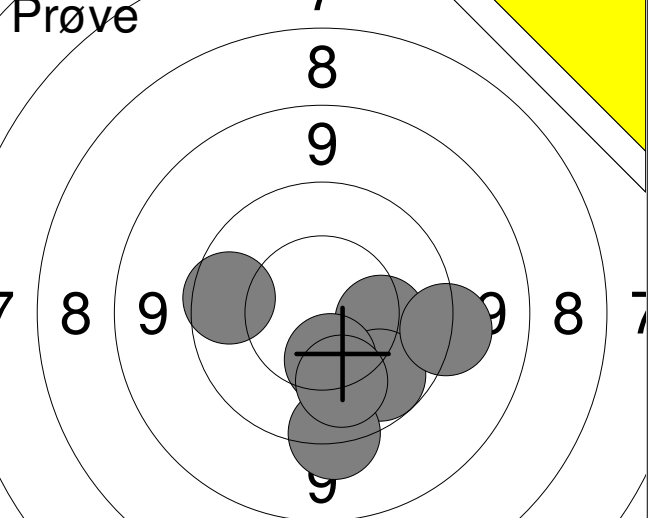

1:	10.2	→
2:	10.0	↘
3:	9.5	↓
4:	9.8	←
5:	10.4	↓
6:	9.4	→
7:	10.1	↓

Serie	67 (0x)
Total	0 (0x)

20 Skud

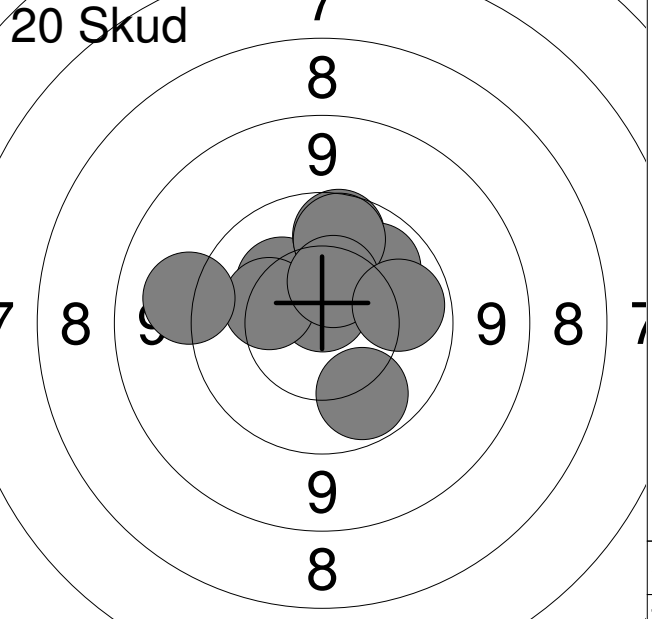

1:	10.7x	↑
2:	10.3	↗
3:	9.9	↑
4:	10.0	↗
5:	10.3	←
6:	9.9	↑
7:	10.4	↑
8:	10.0	→
9:	9.3	←
10:	10.0	↓

Serie	97 (1x)
Total	97 (1x)

20 Skud

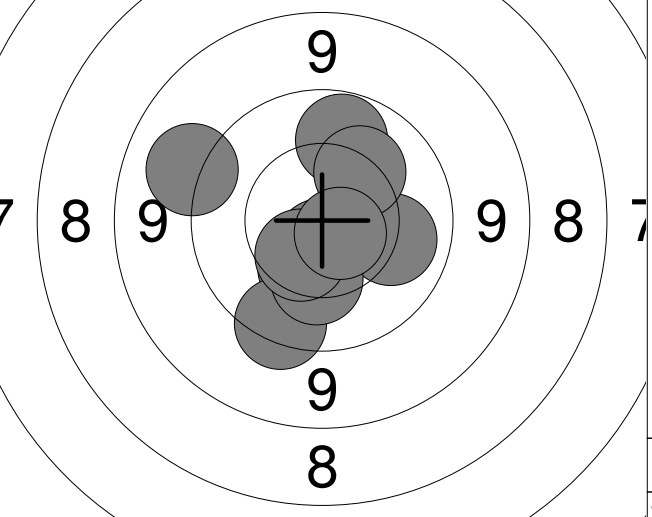

11:	10.3	↓
12:	9.2	←
13:	10.1	→
14:	10.0	↑
15:	10.7x	↓
16:	9.6	↓
17:	10.3	↓
18:	10.5	↘
19:	10.2	↗
20:	10.7x	↘

Serie	98 (2x)
Total	195 (3x)

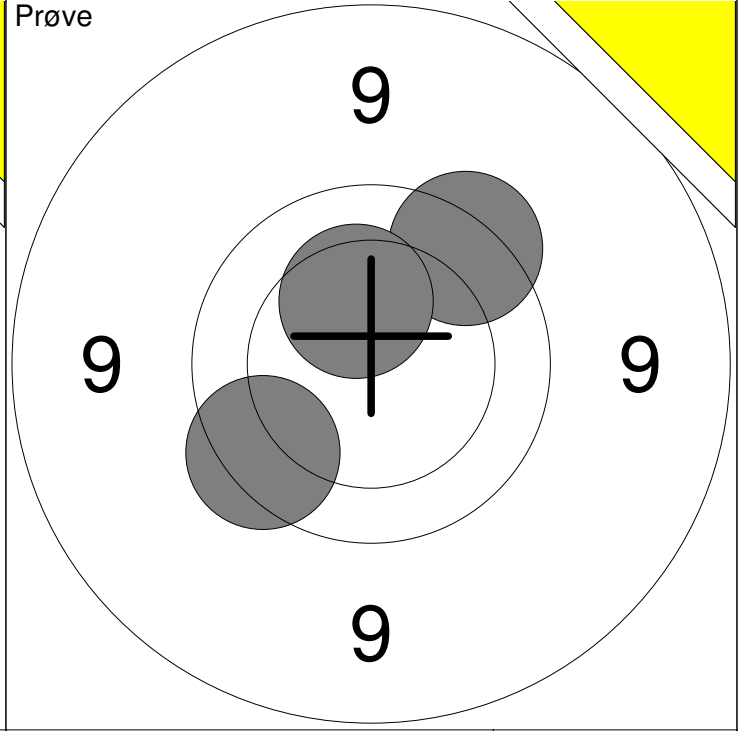
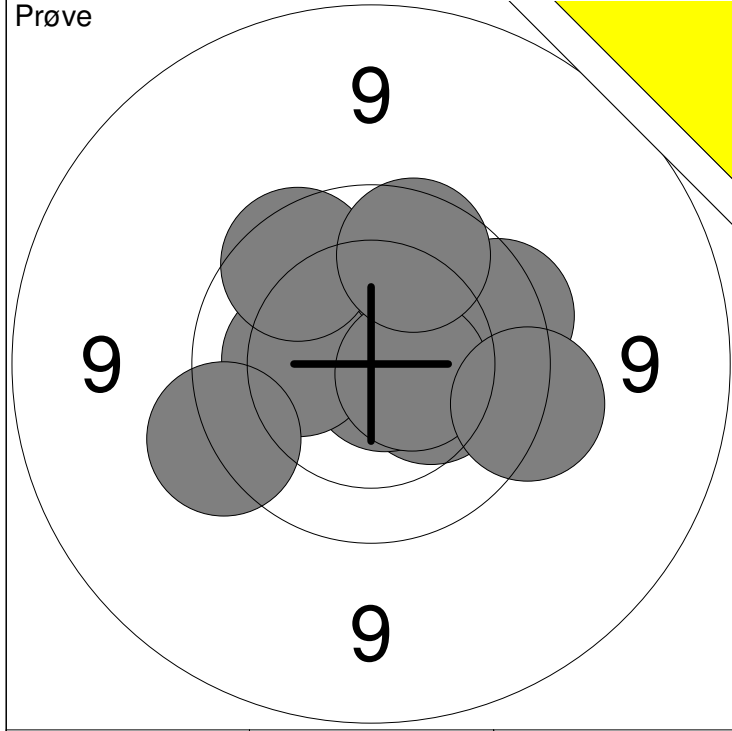

1: 10.3 →	6: 10.5x →	Serie	95 (2x)
2: 10.3 ↗	7: 9.8 ↖		
3: 9.8 →	8: 9.9 ↗	Total	0 (0x)
4: 10.8x ↘	9: 9.6 ←		
5: 10.2 ←	10: 9.6 →		

11: 9.7 ↗	Serie	28 (0x)
12: 9.7 ↙		
13: 10.3 ↗	Total	0 (0x)

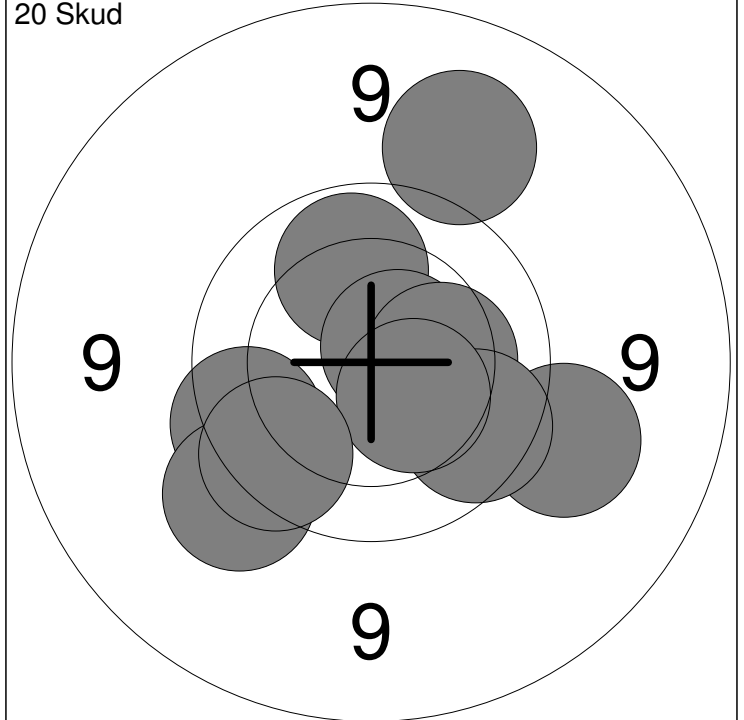
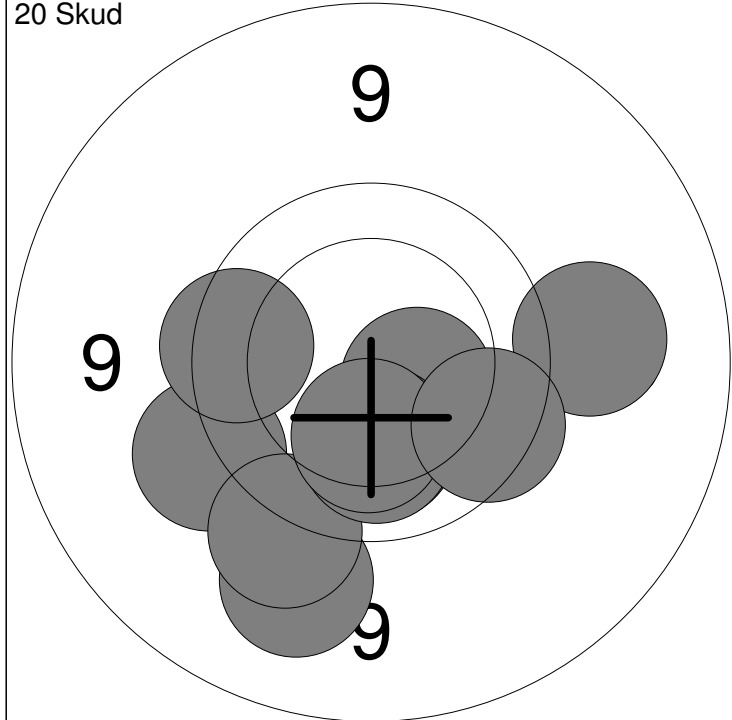

1: 10.5 →	6: 10.2 ↓	Serie	94 (0x)
2: 9.2 ↓	7: 9.3 →		
3: 9.5 ↙	8: 10.1 ↓	Total	94 (0x)
4: 9.8 ←	9: 10.2 ↓		
5: 9.5 ↘	10: 9.8 →		

11: 10.0 ↗	16: 9.2 ↗	Serie	94 (1x)
12: 9.4 →	17: 9.8 ↘		
13: 10.6x ↗	18: 10.4 ↘	Total	188 (1x)
14: 10.3 →	19: 9.5 ↙		
15: 9.7 ↙	20: 9.8 ↙		

Hold 25	Skive 2	
-------------------	-------------------	--

15 meter		
----------	--	--

Nordjysk mesterskab 2019	Aalborg Skyttekreds
--------------------------	---------------------

Prøve

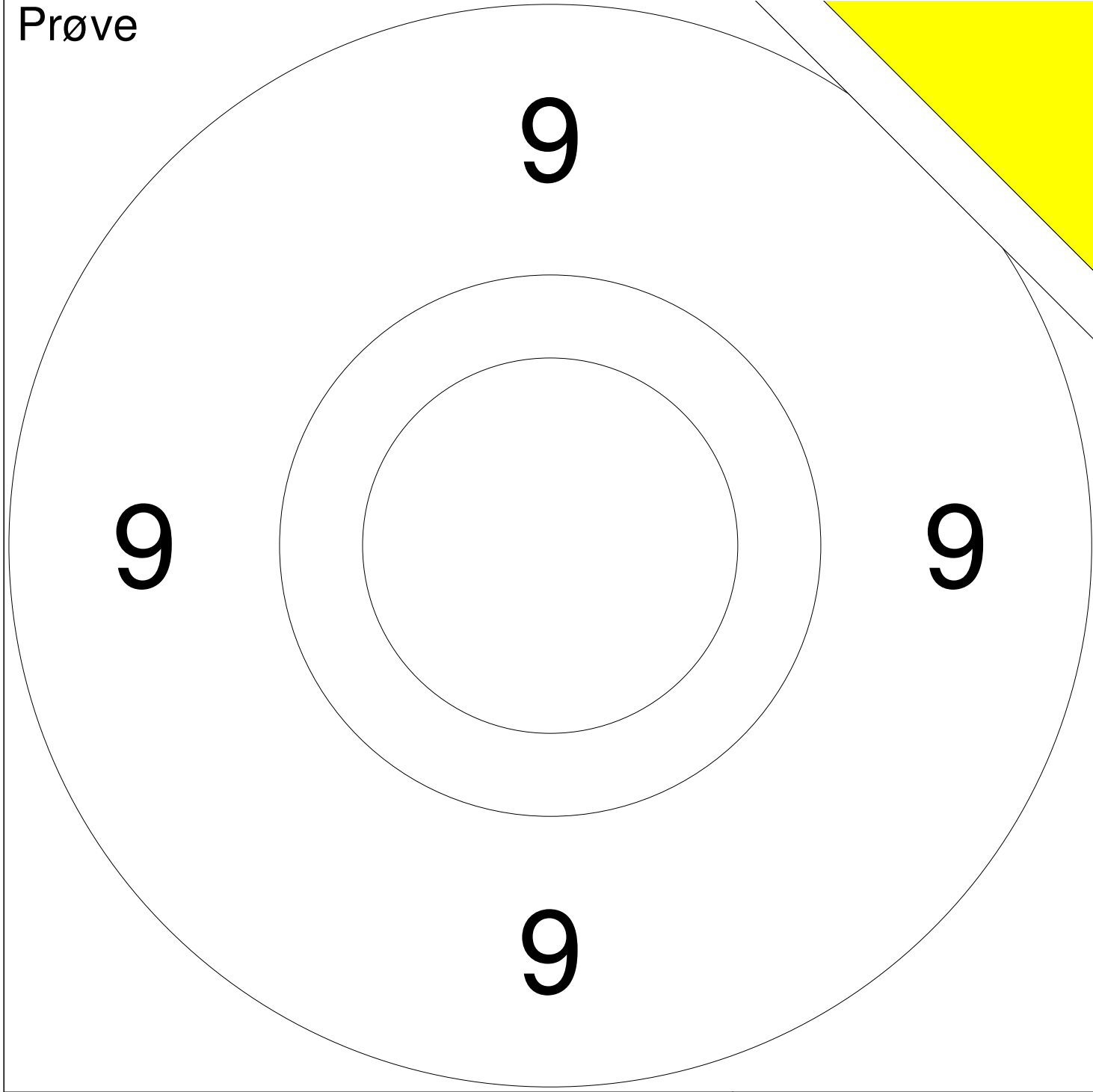

	Serie	0 (0x)
	Total	0 (0x)

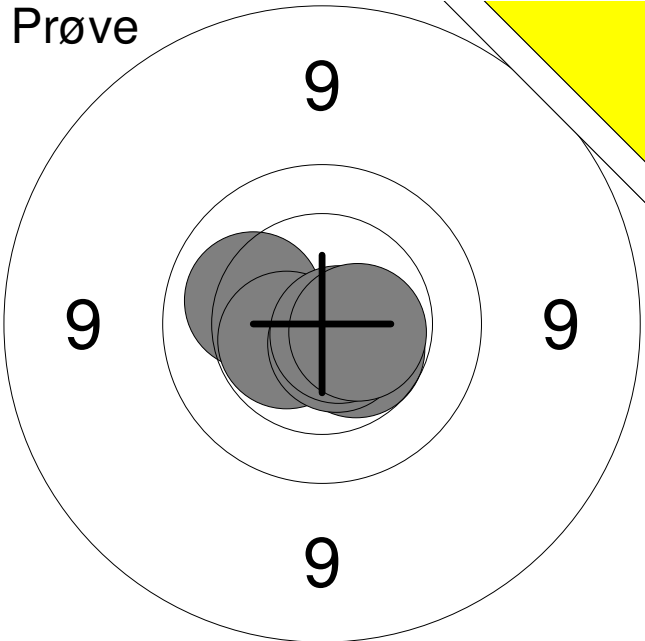
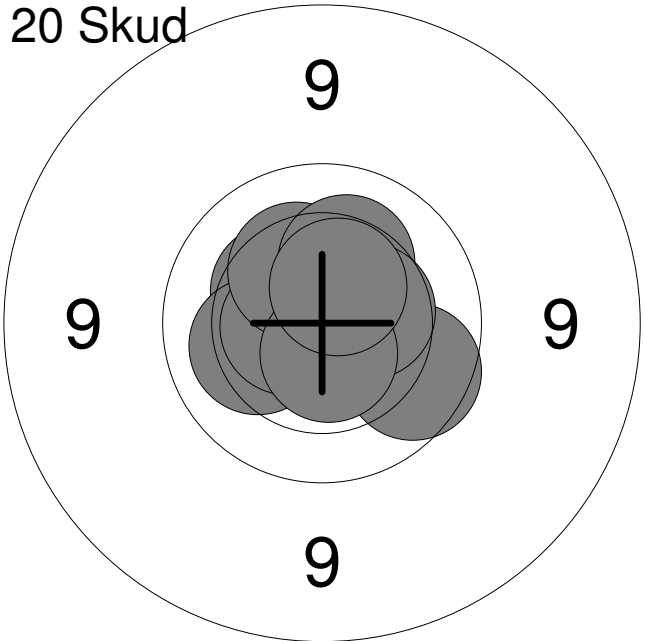
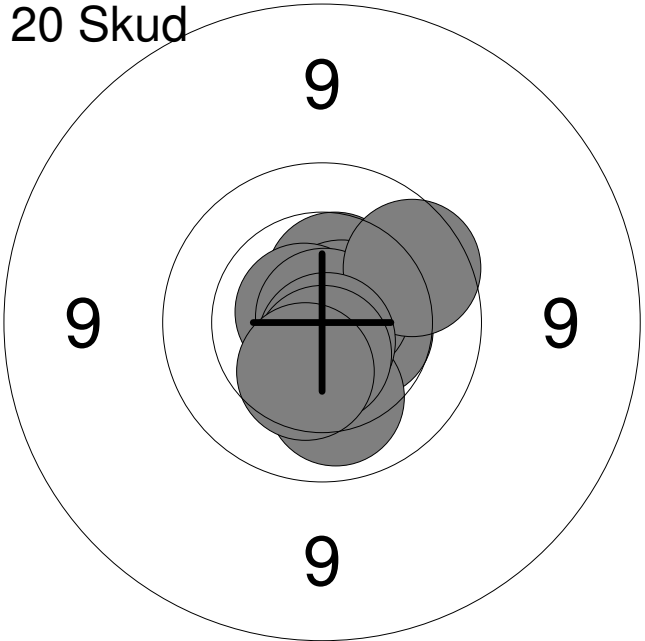
Hold 25	Skive 3	Mathias Hejlesen_Kristensen		
15 meter		Vester Hassing Skytteforening		BK1
		Nordjysk mesterskab 2019	Aalborg Skyttekreds	
Prøve		1:	10.1	↖
		2:	10.5	↘
		3:	10.5x	↖
		4:	10.7x	↘
		5:	10.7x	↘
		6:	10.5x	→
		Serie	60 (4x)	
		Total	0 (0x)	
20 Skud		1:	10.8x	↓
		2:	10.4	↗
		3:	9.9	↘
		4:	10.2	↖
		5:	10.6x	↖
		6:	10.3	↗
		7:	10.2	↗
		8:	10.4	→
		9:	10.6x	↓
		10:	10.5x	↗
		Serie	99 (4x)	
		Total	99 (4x)	
20 Skud		11:	10.5	↗
		12:	10.5	→
		13:	10.7x	↗
		14:	10.1	↓
		15:	10.7x	↖
		16:	10.9x	↗
		17:	9.9	↗
		18:	10.7x	↓
		19:	10.6x	↓
		20:	10.4	↓
		Serie	99 (5x)	
		Total	198 (9x)	

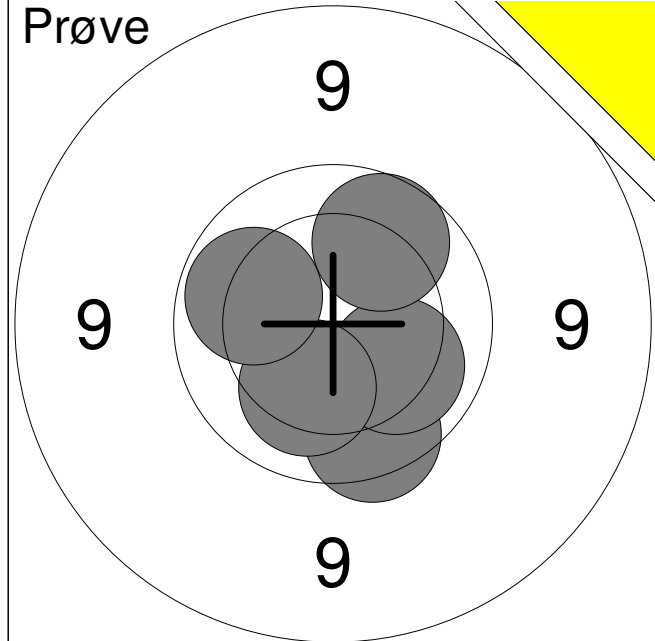

1:	9.8	↓
2:	10.1	↘
4:	9.9	↗
5:	10.2	↓
6:	10.0	←
Serie		48 (0x)
Total		0 (0x)

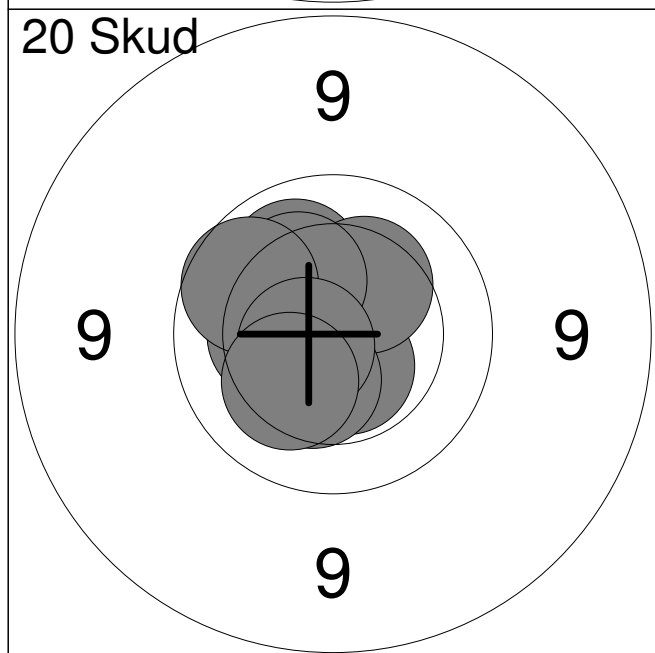

1:	10.1	↗
2:	10.6x	↑
3:	10.6x	↓
4:	10.3	←
5:	10.3	↗
6:	10.2	↗
7:	9.9	↗
8:	10.4	↓
9:	10.6x	←
10:	10.2	↘
Serie		99 (3x)
Total		99 (3x)

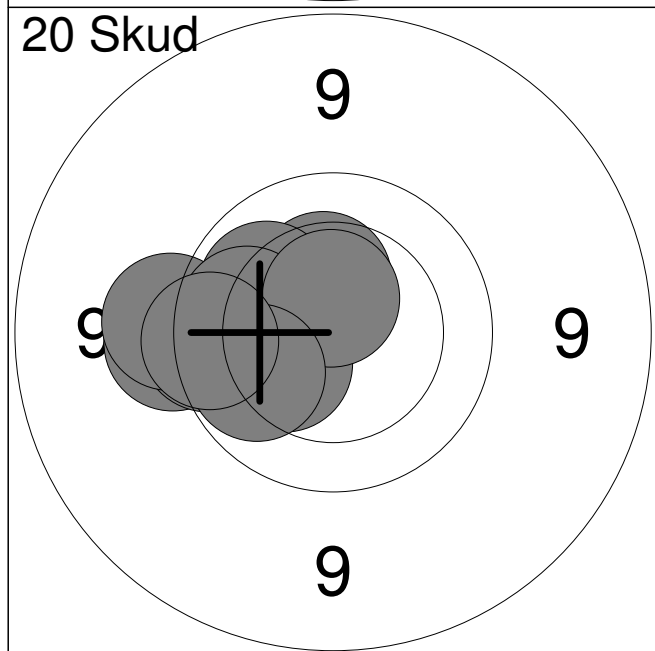

11:	9.5	←
12:	10.4	↑
13:	10.1	↗
14:	9.7	←
15:	9.5	←
16:	10.0	←
17:	10.3	↘
18:	10.6x	↑
19:	10.0	↘
20:	9.7	←
Serie		96 (1x)
Total		195 (4x)

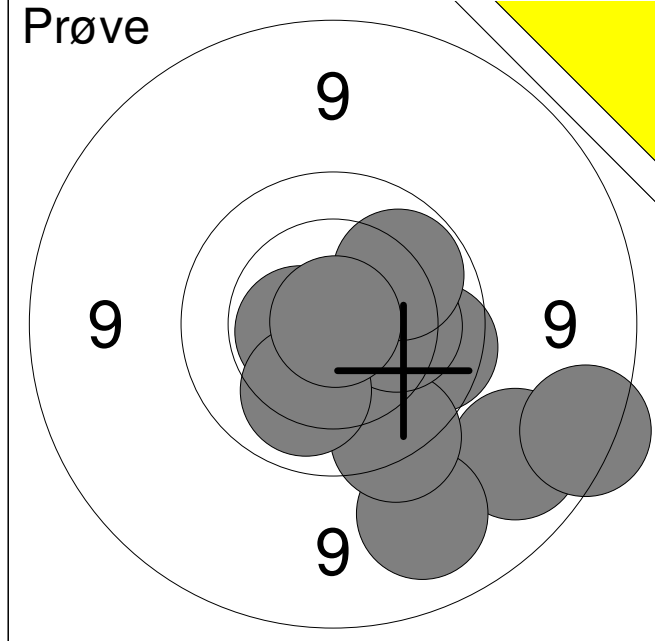

1:	9.0	↘
2:	8.8	→
3:	9.8	→
4:	9.1	↘
5:	9.7	↘
6:	10.2	→
7:	10.0	↗
8:	10.6x	←
9:	10.1	↘
10:	10.9x	↗
Serie		94 (2x)
Total		0 (0x)

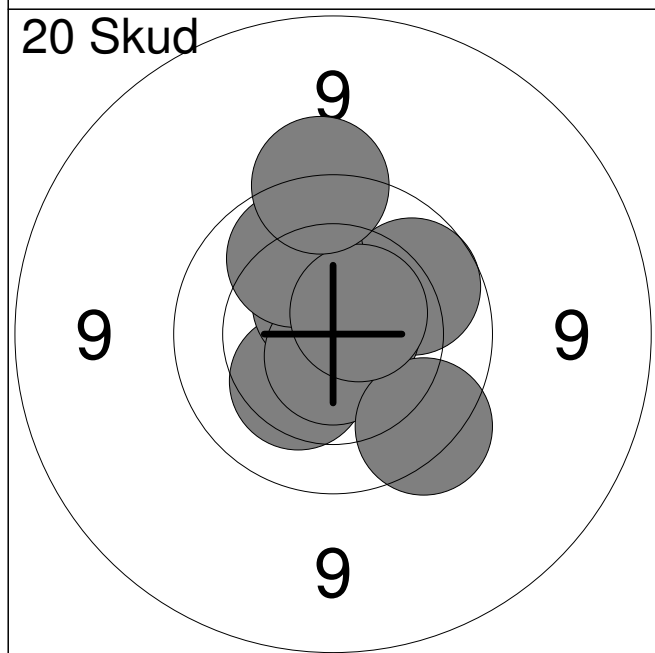

1:	10.3	↘
2:	10.8x	→
3:	9.9	↗
4:	10.7x	→
5:	10.6x	↑
6:	10.7x	↘
7:	10.0	↗
8:	9.7	↘
9:	10.6x	↗
10:	9.6	↑
Serie		97 (5x)
Total		97 (5x)

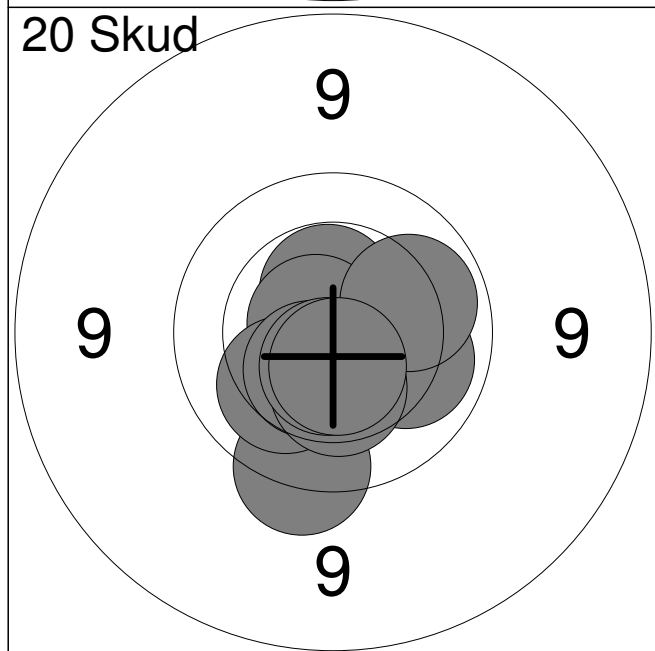

11:	10.5x	↑
12:	9.7	↘
13:	10.7x	↖
14:	10.2	↘
15:	10.1	→
16:	10.5	↘
17:	10.1	↗
18:	10.3	↘
19:	10.6x	↘
20:	10.6x	↘
Serie		99 (4x)
Total		196 (9x)

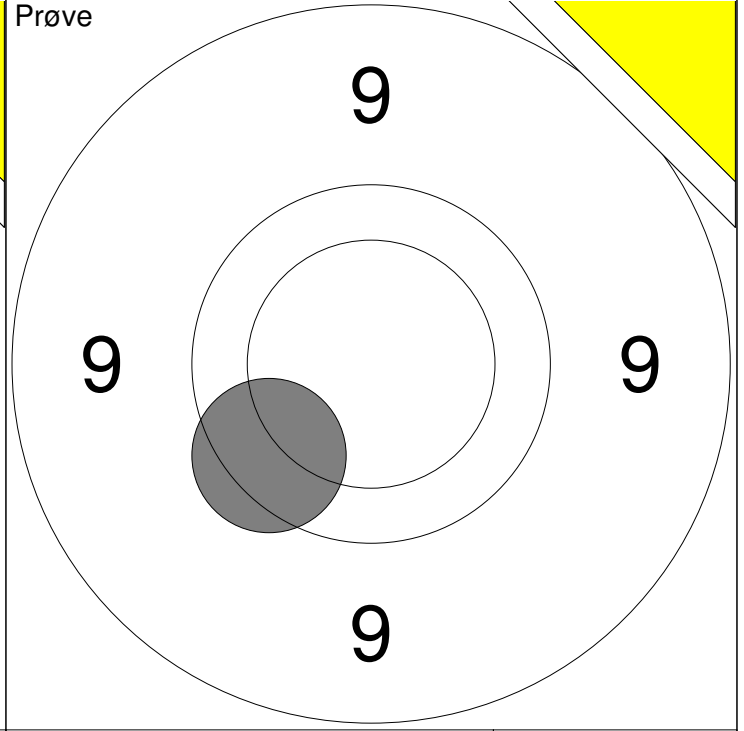
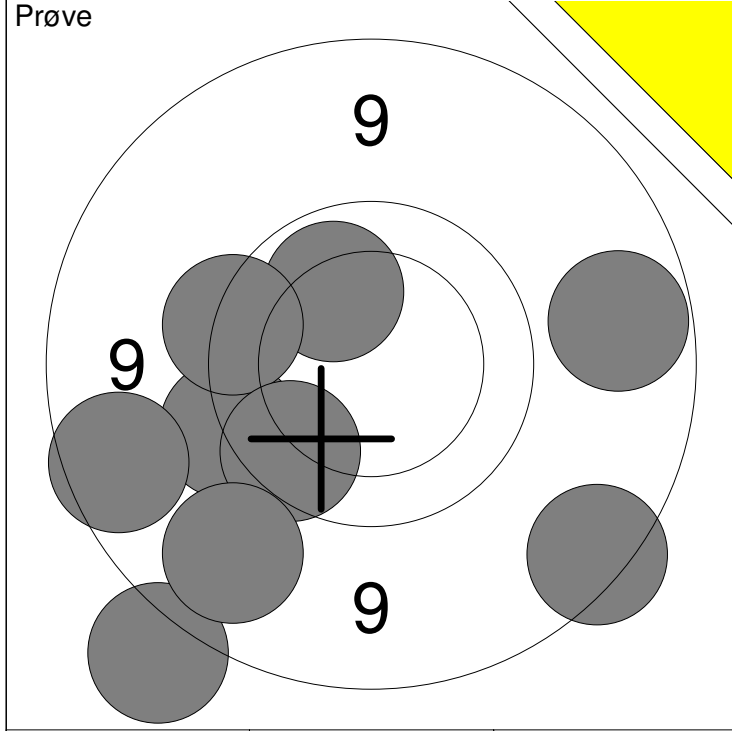

1: 8.8 ↘	7: 9.6 ←	Serie	79 (0x)
3: 8.5 ↓	8: 9.8 ↘		
4: 9.6 ←	9: 9.0 →	Total	0 (0x)
5: 10.1 ↗	10: 9.1 ↘		
6: 8.9 ←			

11: 9.8 ↙		Serie	9 (0x)
		Total	0 (0x)

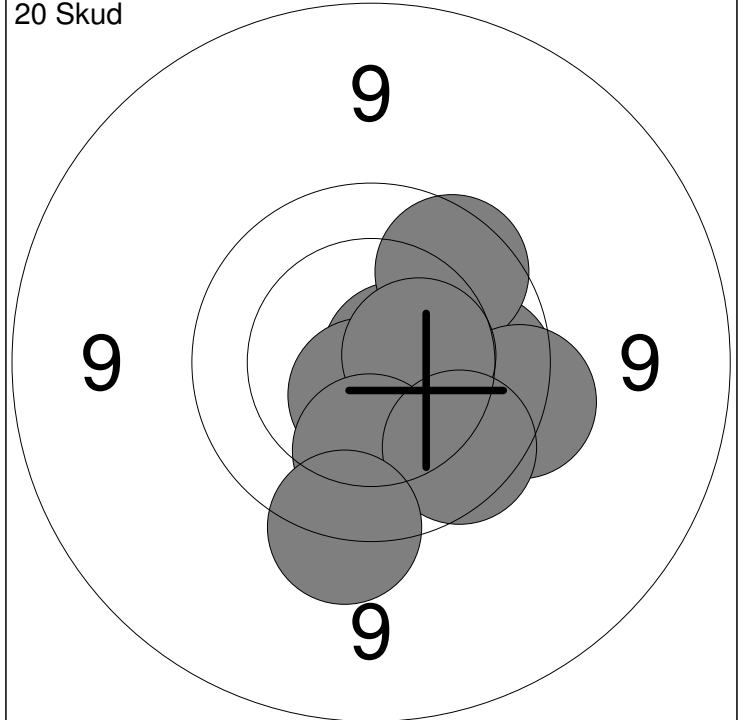
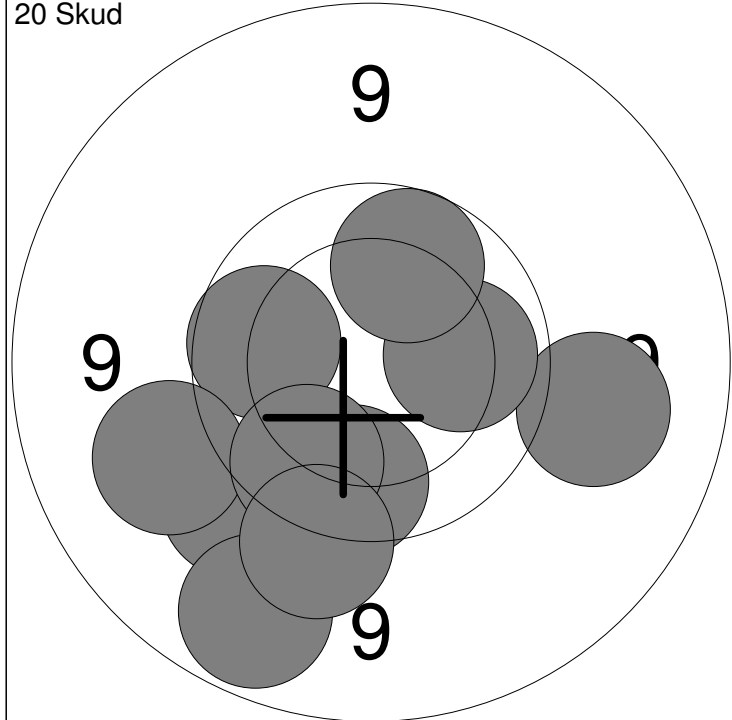

1: 9.4 ↙	6: 9.9 ↘	Serie	91 (0x)
2: 9.9 ←	7: 9.5 ↓		
3: 9.8 ↓	8: 9.3 →	Total	91 (0x)
4: 9.0 ↓	9: 10.1 →		
5: 9.3 ←	10: 9.9 ↗		

11: 9.9 →	16: 10.6x ↓	Serie	94 (2x)
12: 9.9 →	17: 10.5 →		
13: 10.7x →	18: 10.1 ↓	Total	185 (2x)
14: 9.8 ↗	19: 9.8 ↘		
15: 9.7 →	20: 9.6 ↓		

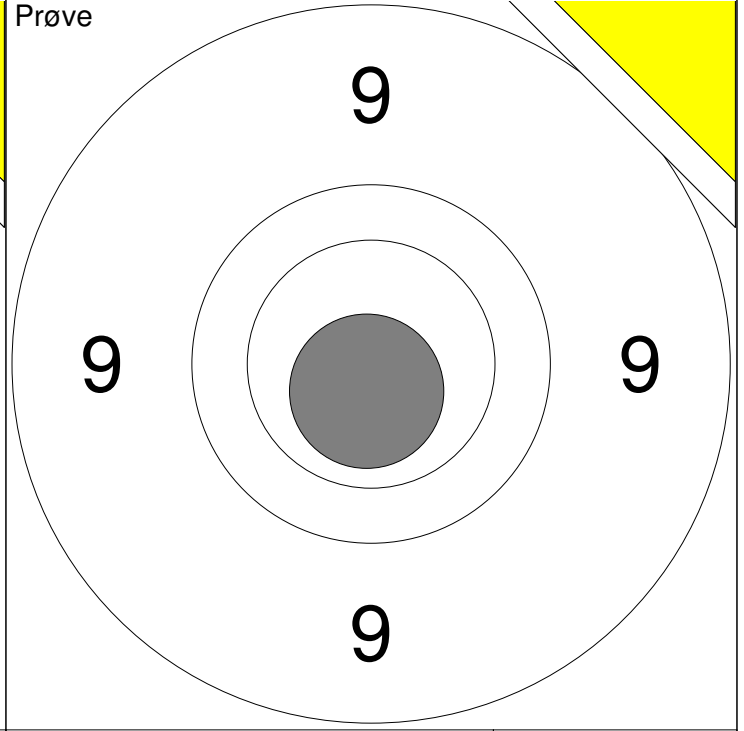
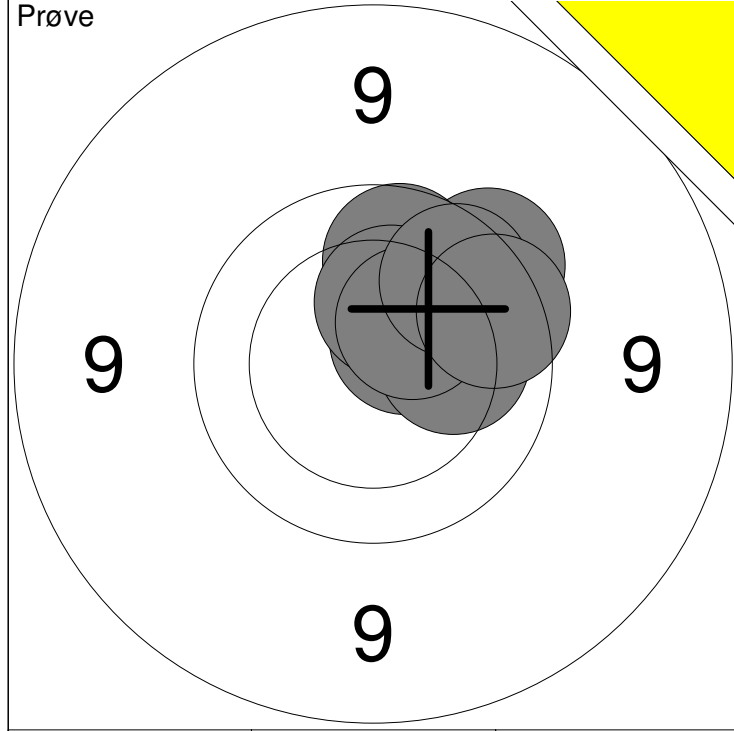

1: 10.5x ↗	7: 10.3 ↗	Serie	86 (1x)
2: 10.2 →	8: 10.4 ↗		
4: 9.7 ↗	9: 9.9 ↗	Total	0 (0x)
5: 10.0 ↗	10: 9.8 →		
6: 9.9 ↗			

12: 10.7x ↓	Serie	10 (1x)
	Total	0 (0x)

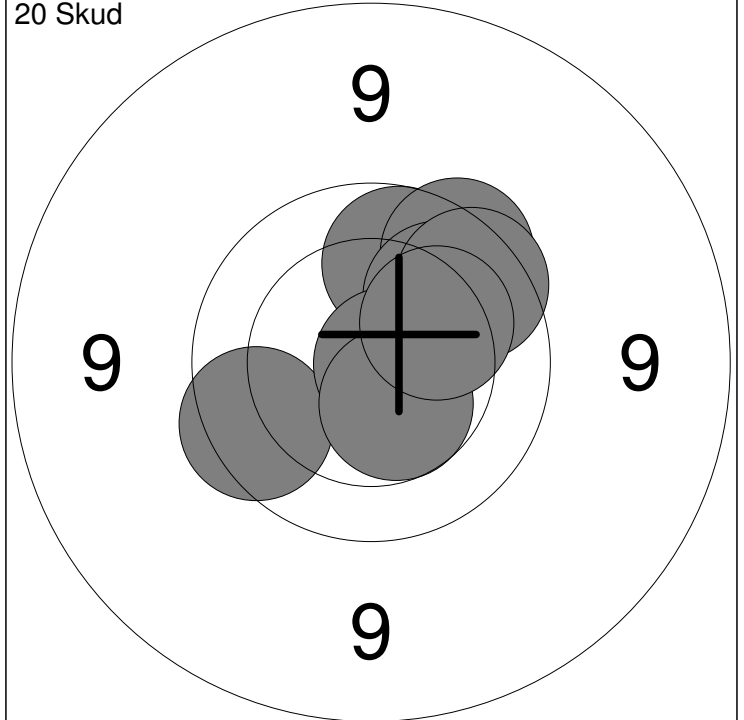
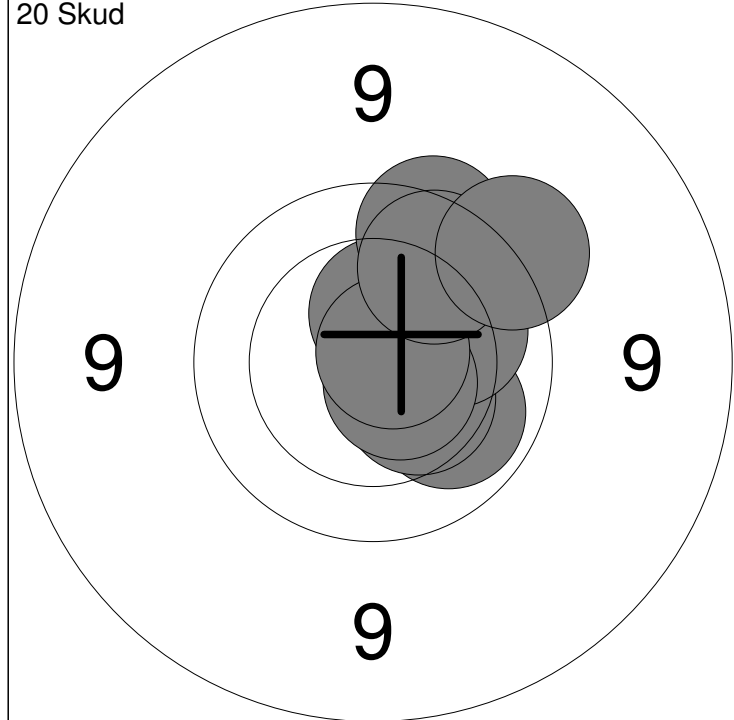

1: 10.1 ↘	6: 10.6x ↘	Serie	97 (3x)
2: 10.5 ↗	7: 10.7x ↗		
3: 10.4 ↘	8: 9.7 ↗	Total	97 (3x)
4: 10.7x ↗	9: 9.9 ↗		
5: 10.1 ↗	10: 9.5 ↗		

11: 9.9 ↗	16: 9.8 ↖	Serie	95 (2x)
12: 9.9 ↗	17: 10.8x →		
13: 9.8 ↗	18: 9.8 ↗	Total	192 (5x)
14: 10.0 ↗	19: 10.5 ↓		
15: 10.7x →	20: 10.2 ↗		

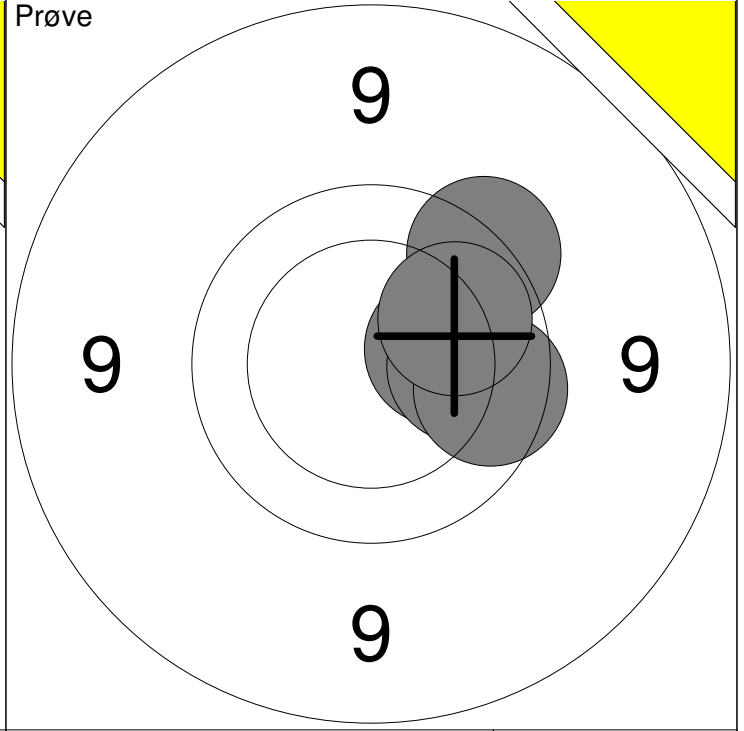
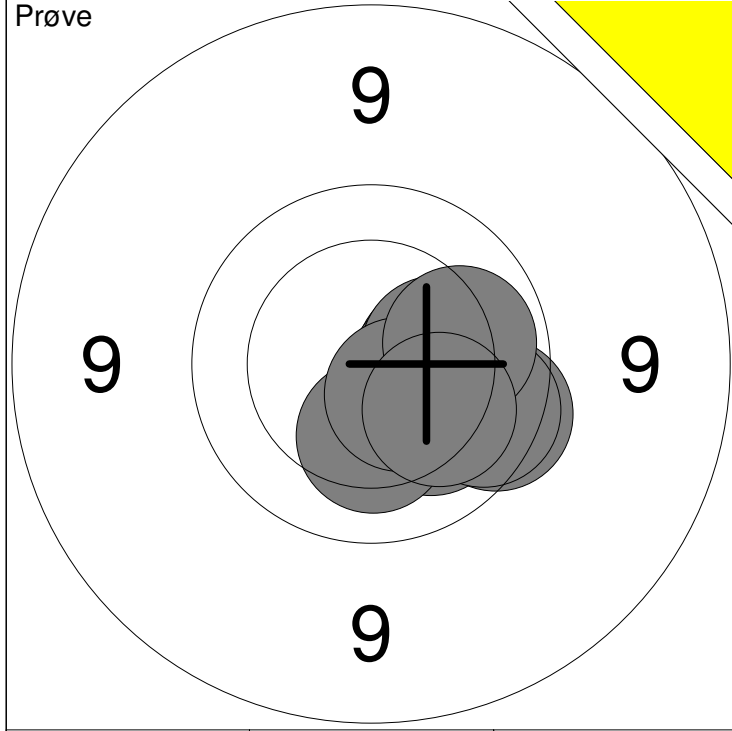

1: 10.4 →	6: 10.2 ↓	Serie	98 (1x)
2: 9.8 ↘	7: 10.5x ↘		
3: 10.4 →	8: 9.8 ↘	Total	0 (0x)
4: 10.3 →	9: 10.1 →		
5: 10.2 ↘	10: 10.2 ↘		

11: 10.2 →	Serie	48 (0x)
12: 9.6 ↗		
13: 10.0 →	Total	0 (0x)
14: 9.8 →		
15: 10.0 ↗		

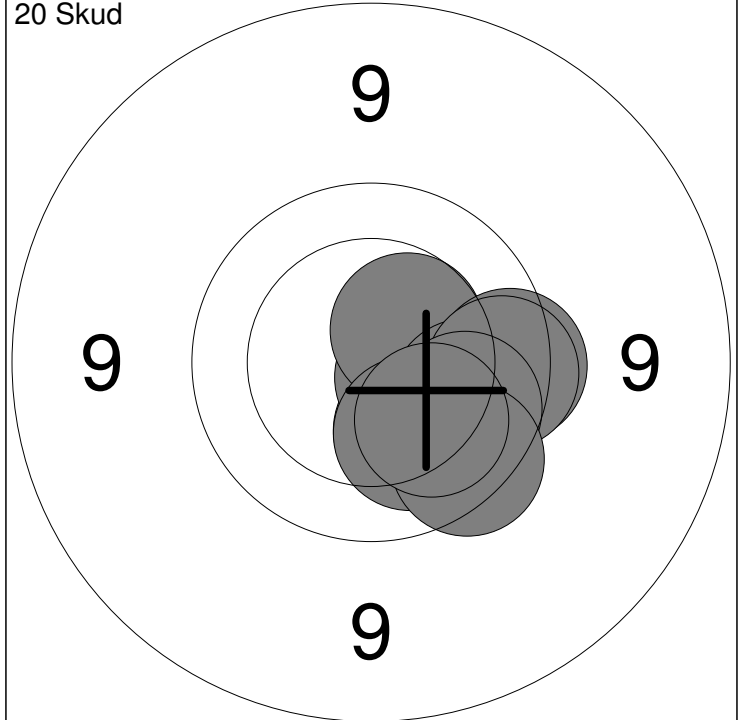
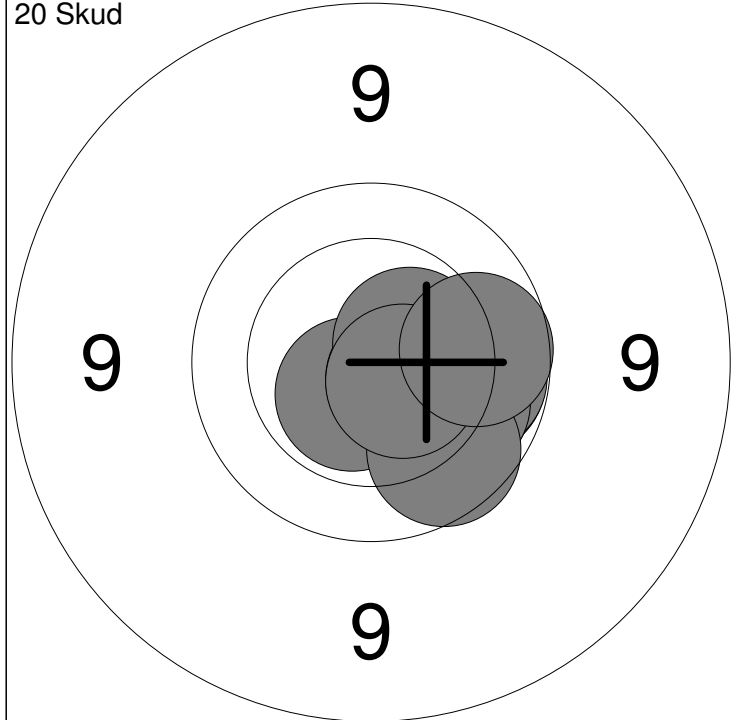

1: 10.6x ↘	6: 10.0 →	Serie	98 (4x)
2: 10.0 →	7: 10.1 ↘		
3: 10.1 ↘	8: 9.9 ↘	Total	98 (4x)
4: 10.6x ↘	9: 10.6x ↘		
5: 10.5x ↗	10: 9.9 →		

11: 10.2 ↓	16: 9.7 →	Serie	96 (1x)
12: 10.5x →	17: 9.8 →		
13: 10.5 ↗	18: 9.9 ↘	Total	194 (5x)
14: 10.0 →	19: 9.8 ↘		
15: 10.2 ↓	20: 10.1 ↘		

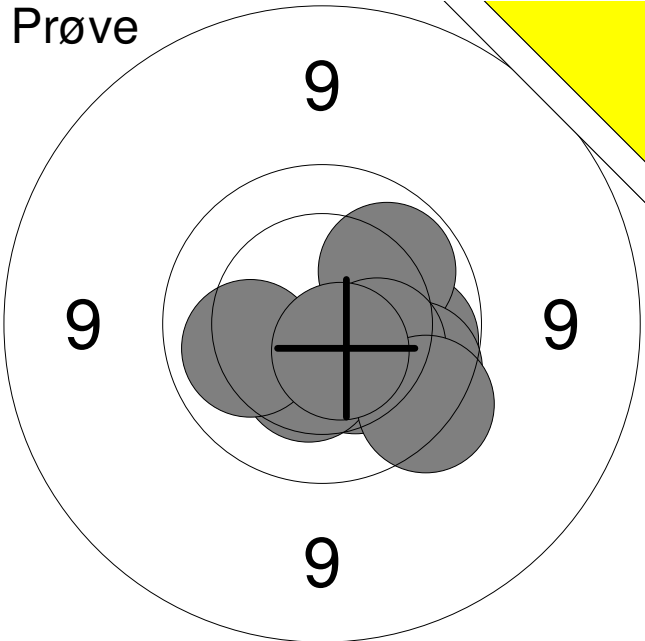
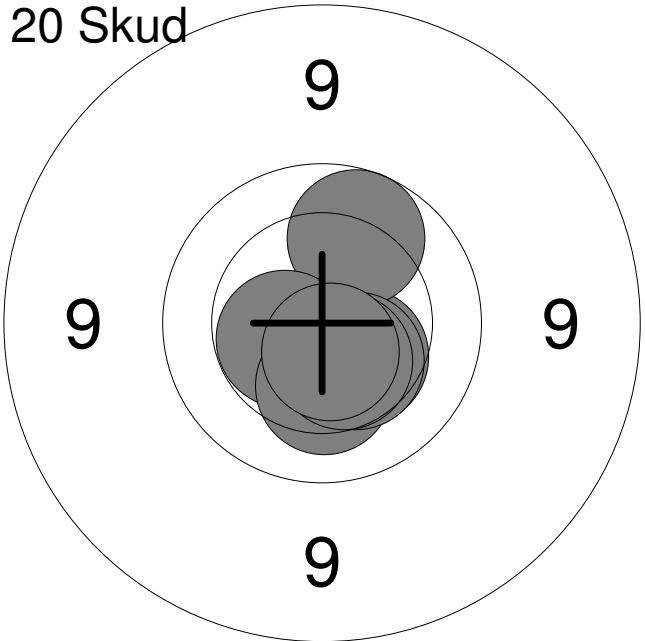
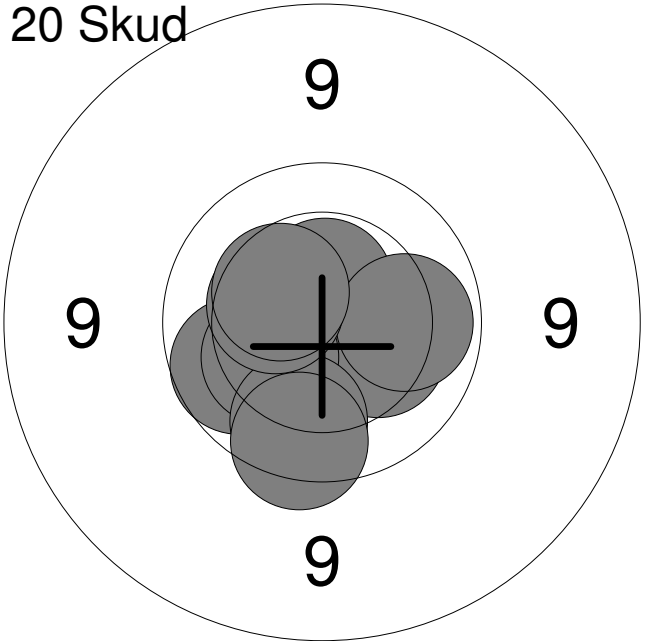
Hold 25	Skive 9	Melissa Andrea Engelbert Hennin		
15 meter		Vester Hassing Skytteforening		BK3
		Nordjysk mesterskab 2019	Aalborg Skyttekreds	
Prøve 		1: 10.0 → 2: 10.0 ↗ 3: 10.4 ↓ 4: 10.4 ↓ 5: 9.9 ↘ 6: 10.3 → 7: 9.7 ↘ 8: 10.1 ← 9: 10.6x ↓		
		Serie		88 (1x)
		Total		0 (0x)
20 Skud 		1: 10.8x ↓ 2: 10.7x ↓ 3: 10.4 ↘ 4: 10.7x ↓ 5: 9.9 ↗ 6: 10.5x ← 7: 10.3 ↓ 8: 10.4 ↓ 9: 10.5 ↓ 10: 10.6x ↓		
		Serie		99 (5x)
		Total		99 (5x)
20 Skud 		11: 10.3 ↓ 12: 10.6x ↑ 13: 10.3 → 14: 9.9 ← 15: 10.3 ← 16: 10.0 → 17: 9.9 ↓ 18: 10.4 ← 19: 9.8 ↓ 20: 10.4 ↗		
		Serie		97 (1x)
		Total		196 (6x)

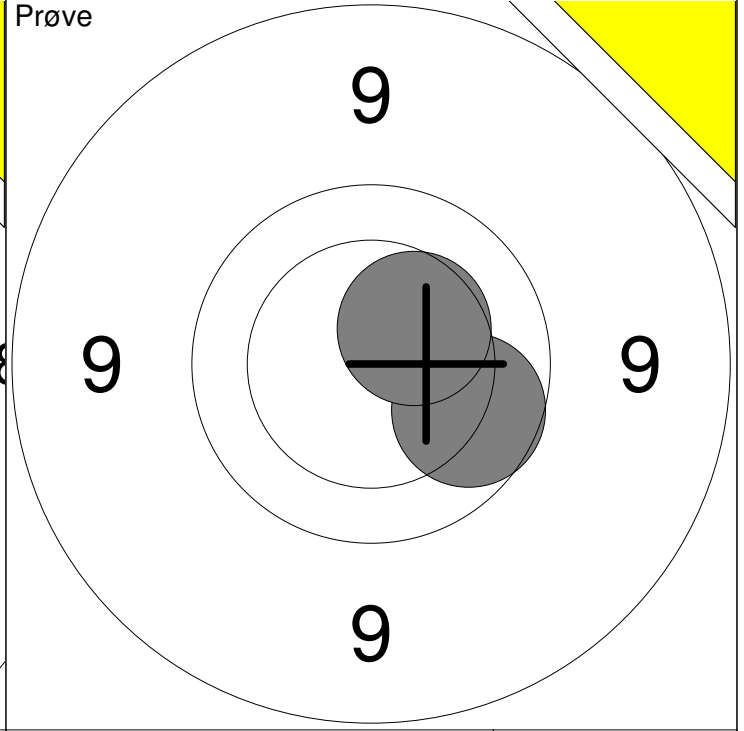
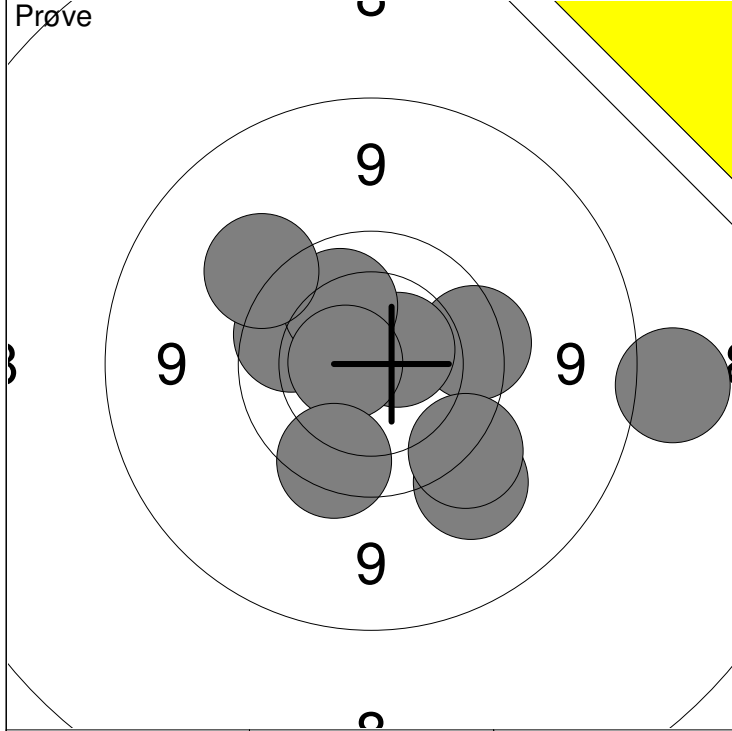

1: 9.4 ↘	6: 10.6x ↗	Serie 92 (2x)
2: 9.7 →	7: 10.1 ↗	
3: 8.5 →	8: 10.6x ←	Total 0 (0x)
4: 9.6 ↘	9: 9.7 ↘	
5: 9.9 ↗	10: 9.4 ↗	

11: 9.9 →	Serie 19 (0x)
12: 10.4 ↗	
	Total 0 (0x)

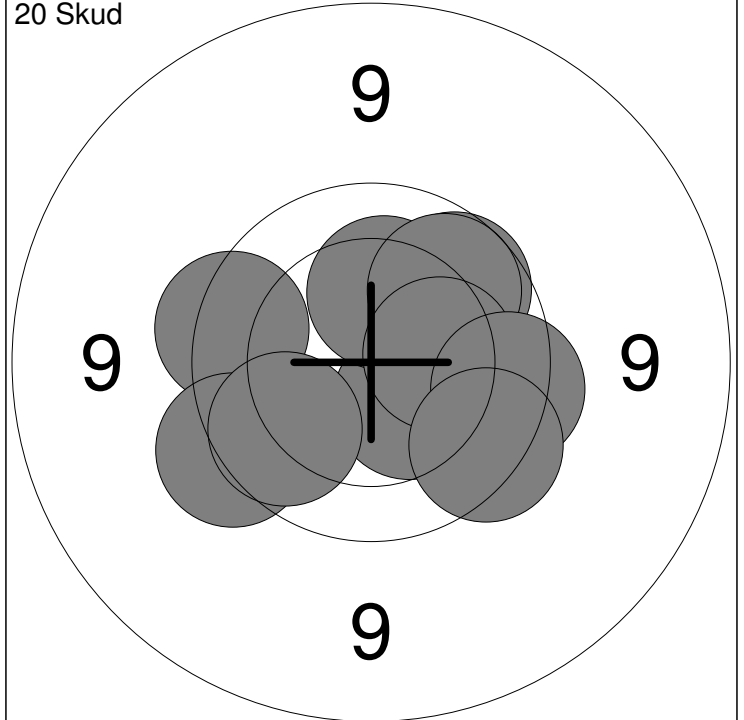
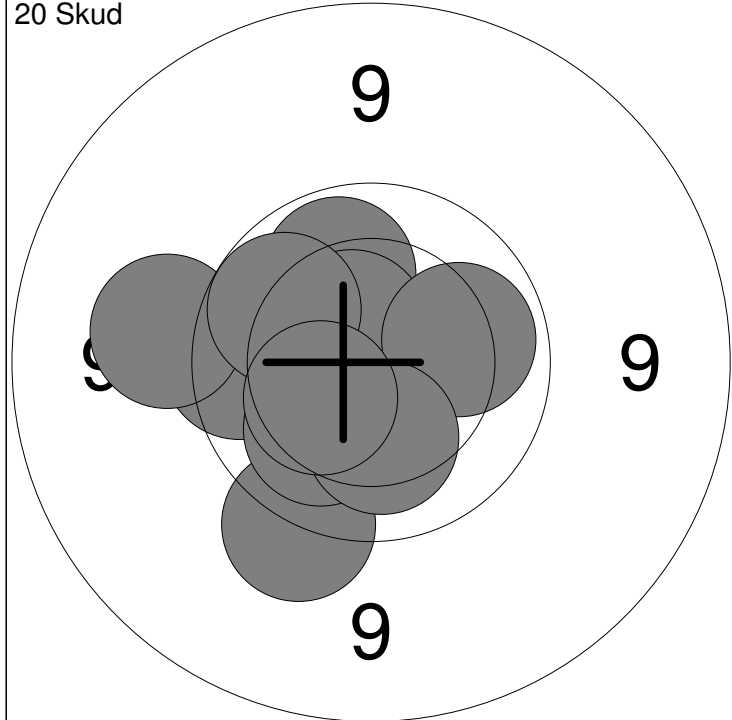

1: 9.5 ↘	6: 10.1 ↘	Serie 97 (1x)
2: 9.8 ←	7: 9.4 ←	
3: 10.0 ↗	8: 10.0 ↗	Total 97 (1x)
4: 10.6x ↗	9: 10.2 ↘	
5: 10.1 →	10: 10.3 ↘	

11: 9.7 ←	16: 9.6 ←	Serie 93 (0x)
12: 10.4 ↘	17: 10.3 →	
13: 10.3 ↗	18: 9.9 ↘	Total 190 (1x)
14: 9.9 ↗	19: 9.7 →	
15: 9.9 ↗	20: 9.7 ↘	

Hold 25	Skive 11	William Roenn		
15 meter		Aalborg Skyttekreds		MBK2
		Nordjysk mesterskab 2019	Aalborg Skyttekreds	
Prøve		1:	10.2	↗
		3:	10.9x	→
		4:	10.4	↓
		5:	10.3	↘
		7:	10.3	→
		Serie	50 (1x)	
		Total	0 (0x)	
20 Skud		1:	10.1	↗
		2:	10.3	→
		3:	10.0	↗
		4:	10.4	↑
		5:	10.6x	↓
		6:	10.5	→
		7:	10.1	↘
		8:	10.2	↓
		9:	10.0	↗
		10:	10.6x	←
		Serie	100 (2x)	
		Total	100 (2x)	
20 Skud		11:	10.7x	↘
		12:	10.2	→
		13:	10.8x	→
		14:	10.7x	↗
		15:	10.2	↑
		16:	10.4	↖
		17:	10.0	→
		18:	9.8	↓
		19:	10.7x	↘
		20:	10.3	↗
		Serie	99 (4x)	
		Total	199 (6x)	

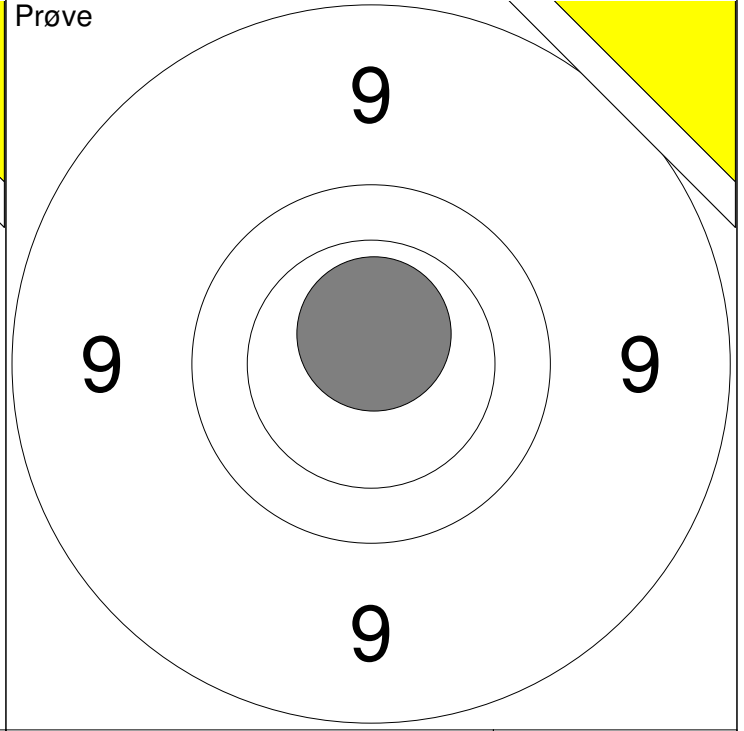
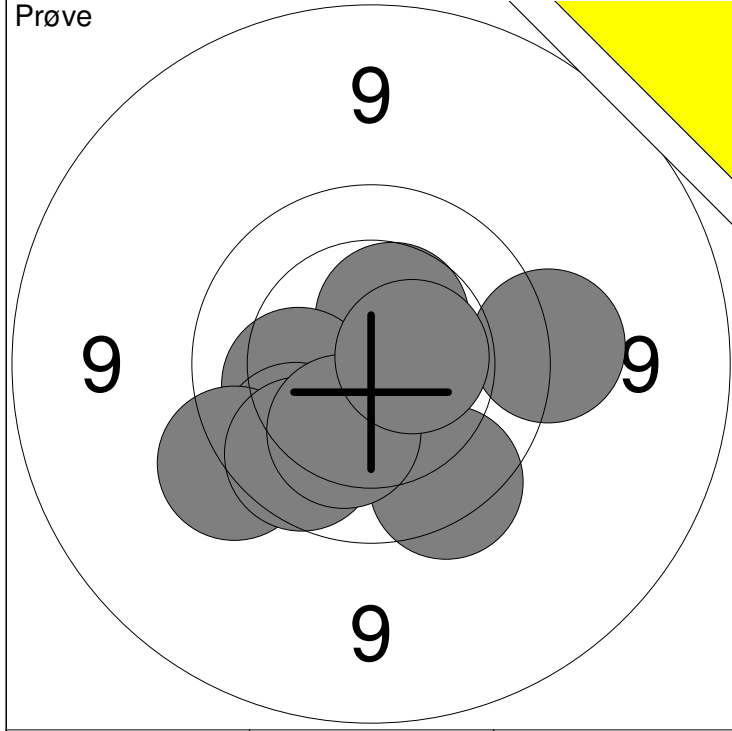

1: 10.5 ↗	6: 9.6 ↙	Serie	95 (1x)
2: 10.0 ↙	7: 9.5 →		
3: 10.2 ↙	8: 9.9 ↙	Total	0 (0x)
4: 9.7 ↘	9: 10.2 ↘		
5: 9.9 ↙	10: 10.5x →		

11: 10.7x ↗	Serie	10 (1x)
	Total	0 (0x)

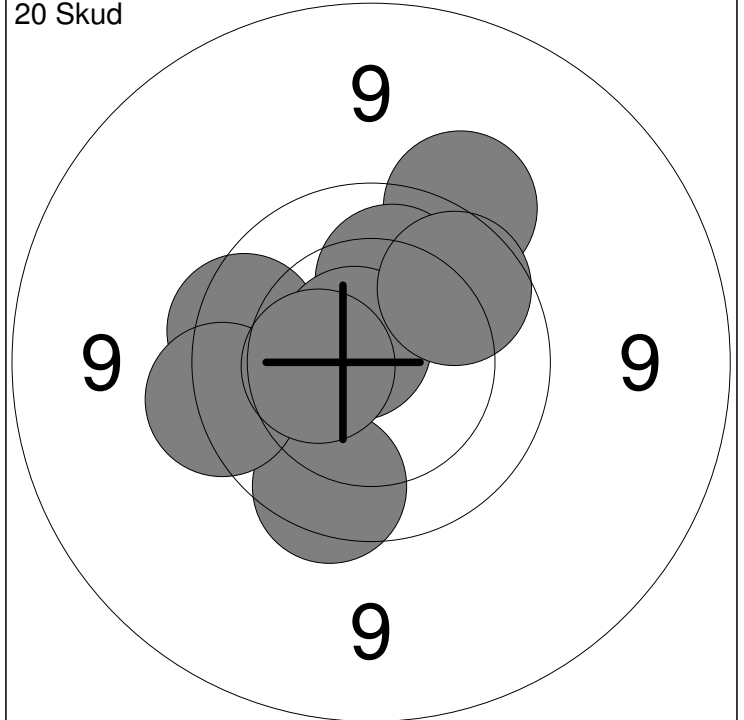
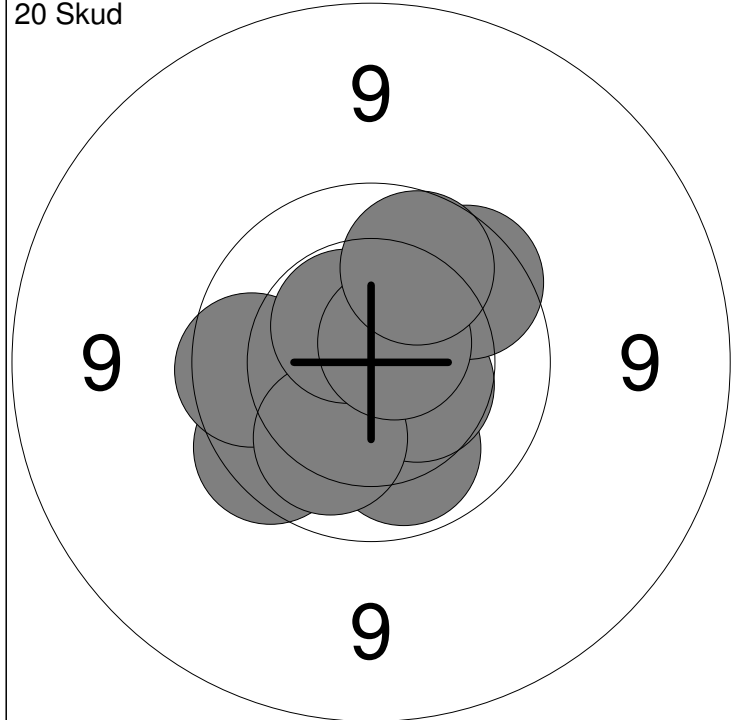

1: 10.0 ↘	6: 10.1 ↘	Serie	96 (3x)
2: 9.8 ↙	7: 9.8 ↗		
3: 9.9 ←	8: 10.5x ↖	Total	96 (3x)
4: 10.6x ↗	9: 10.7x ↗		
5: 10.4 ↘	10: 9.9 ↗		

11: 9.5 ↗	16: 9.8 ↘	Serie	94 (1x)
12: 9.8 ←	17: 10.7x ↖		
13: 10.1 ↗	18: 9.9 ↗	Total	190 (4x)
14: 10.1 ←	19: 9.7 ←		
15: 9.8 ←	20: 10.4 ←		

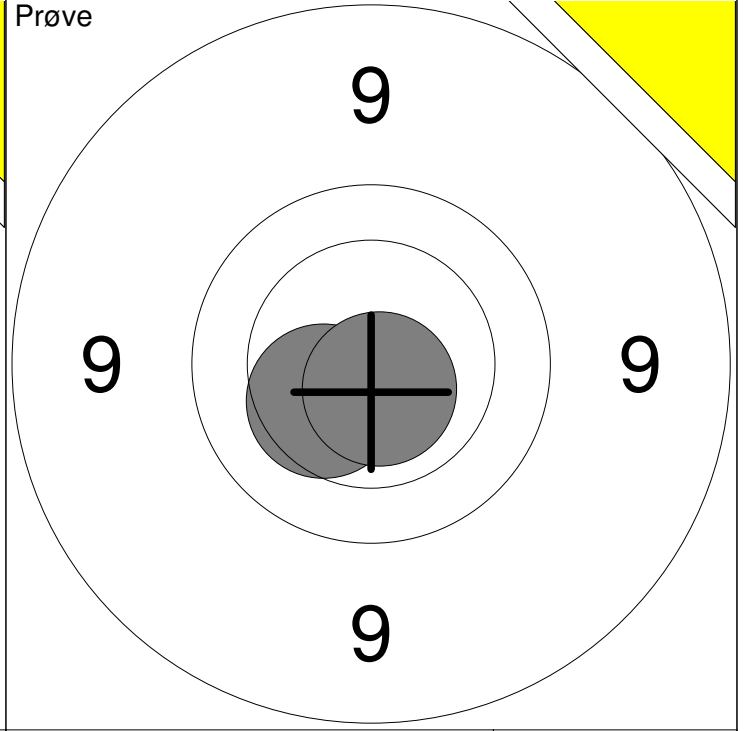
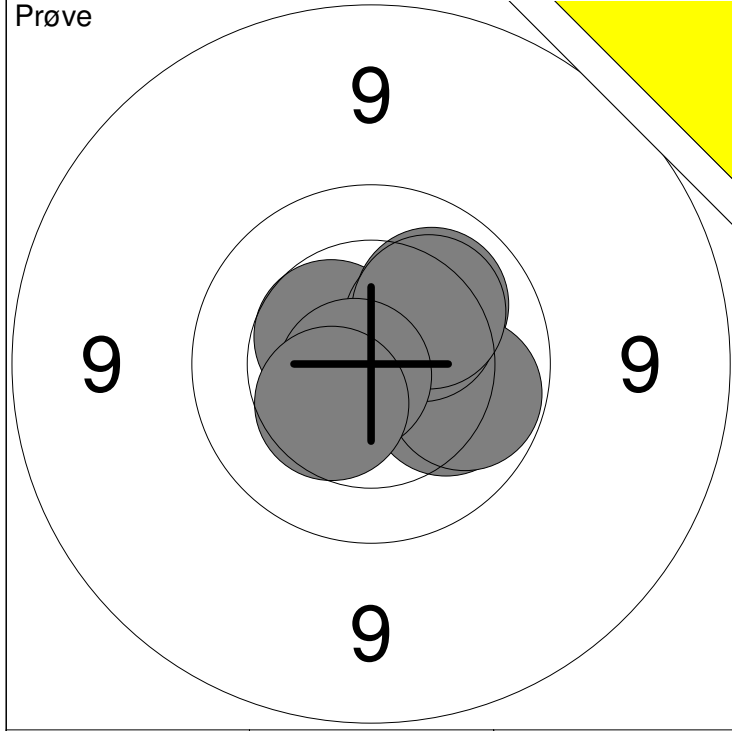

1: 10.7x ↙	6: 10.0 →	Serie 100 (2x)
2: 10.5 ↖	7: 10.3 ↗	
3: 10.5 →	8: 10.2 ↗	Total 0 (0x)
4: 10.1 →	9: 10.8x ↙	
5: 10.1 ↗	10: 10.4 ↙	

11: 10.4 ↙	Serie 20 (1x)
12: 10.7x ↘	
Total 0 (0x)	

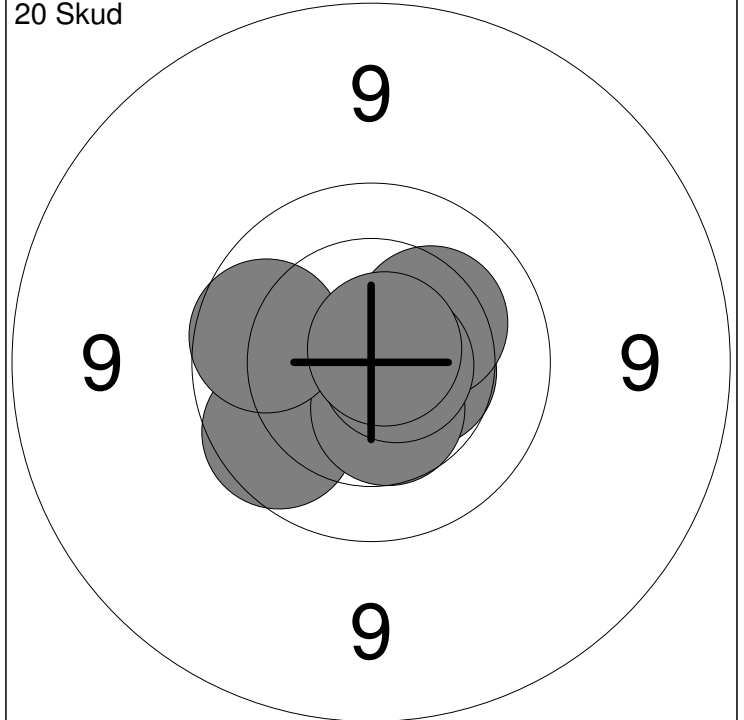
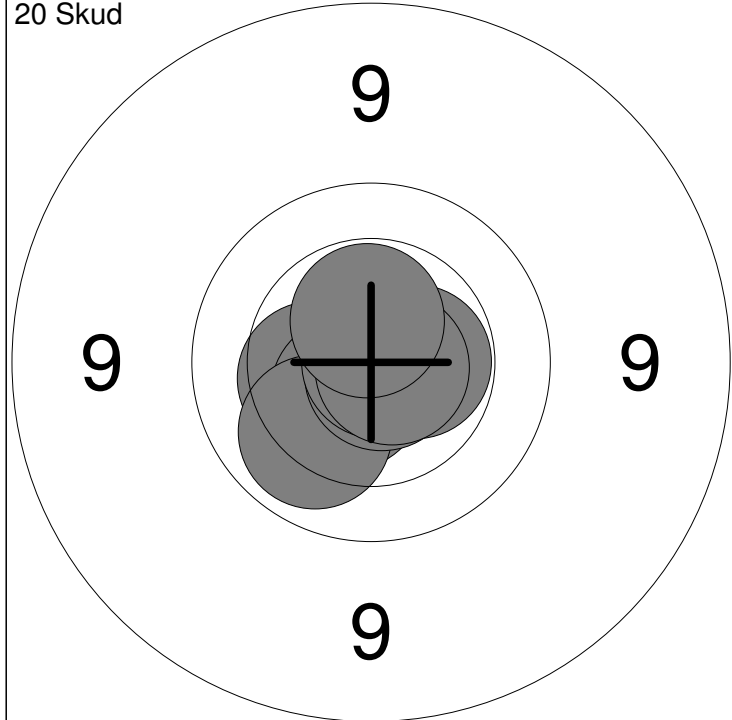

1: 10.7x ↑	6: 10.8x ↘	Serie 100 (8x)
2: 10.7x ↑	7: 10.5x →	
3: 10.4 ↖	8: 10.9x →	Total 100 (8x)
4: 10.6x ↙	9: 10.7x →	
5: 10.1 ↙	10: 10.5x ↑	

11: 10.5 →	16: 9.9 ↙	Serie 98 (5x)
12: 10.7x ↓	17: 10.5 ↓	
13: 10.2 ↗	18: 9.9 ↖	Total 198 (13x)
14: 10.8x ↓	19: 10.7x →	
15: 10.8x ↙	20: 10.8x ↗	

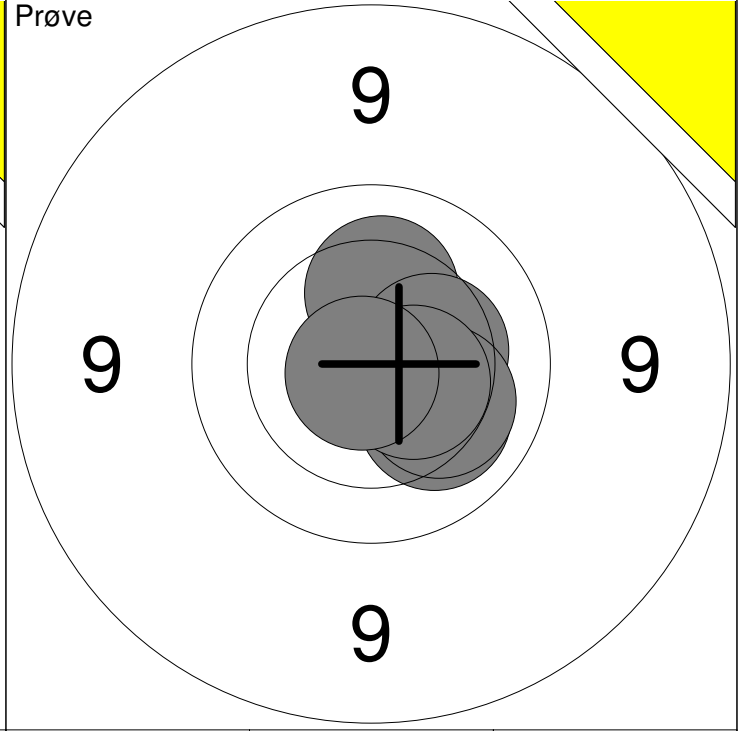
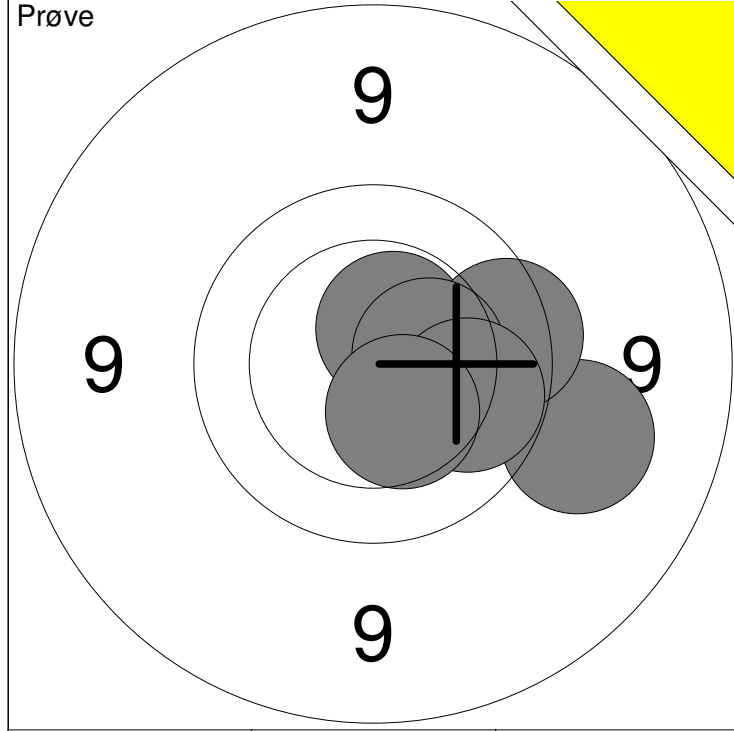

1: 9.3 →	9: 10.0 →	Serie	68 (1x)
3: 10.6x ↗	10: 10.4 ↘		
4: 10.2 →		Total	0 (0x)
6: 9.8 →			
8: 10.4 →			

11: 10.2 ↘	17: 10.5x →	Serie	70 (3x)
13: 10.5x ↗	18: 10.8x ↙		
14: 10.2 ↑		Total	0 (0x)
15: 10.3 →			
16: 10.2 ↘			

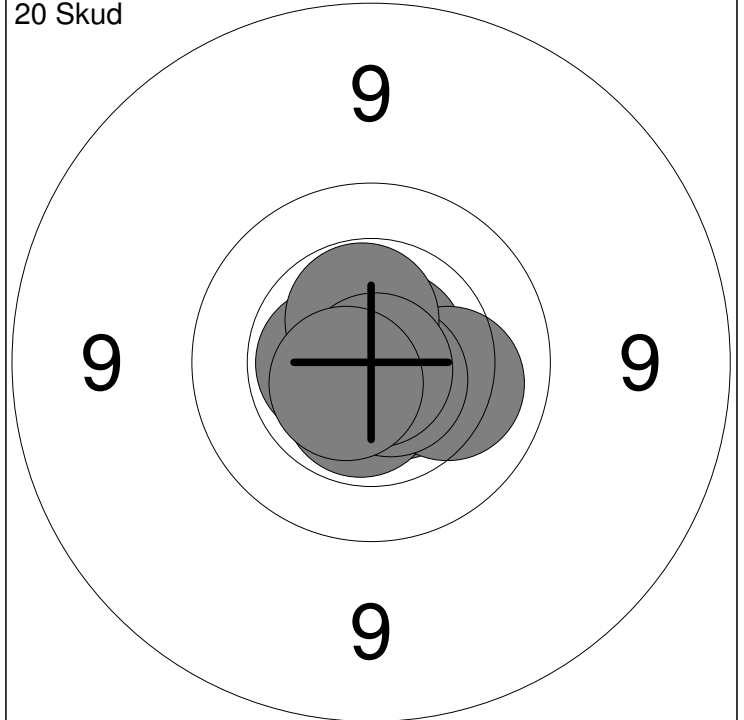
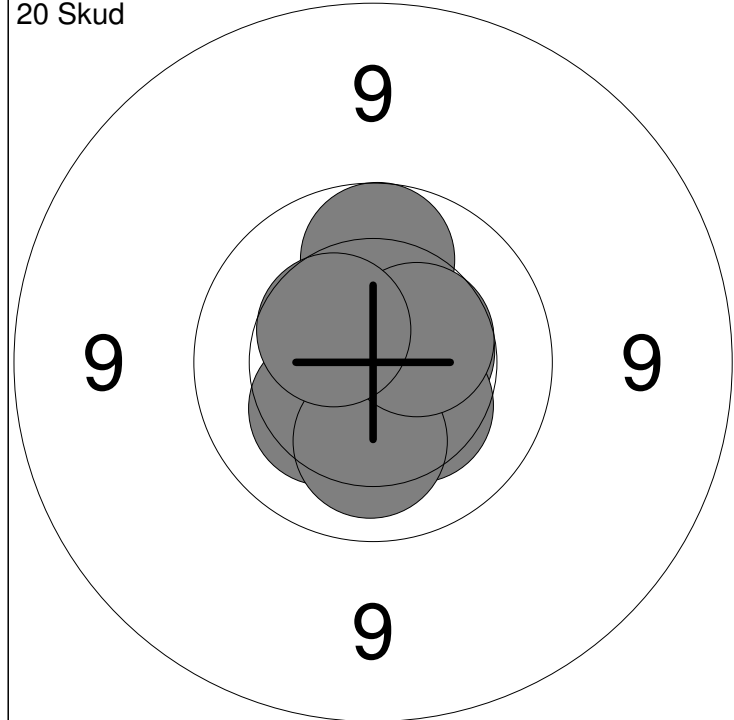

1: 10.5x →	6: 10.7x ↘	Serie	99 (4x)
2: 10.5x ↓	7: 10.4 ↘		
3: 9.9 ↑	8: 10.2 ↓	Total	99 (4x)
4: 10.3 ↙	9: 10.5 ↗		
5: 10.6x →	10: 10.5 ↖		

11: 10.6x ←	16: 10.2 →	Serie	100 (9x)
12: 10.8x ↙	17: 10.7x ↘		
13: 10.6x ↘	18: 10.5x ↑	Total	199 (13x)
14: 10.6x ↓	19: 10.9x ↘		
15: 10.7x ↗	20: 10.6x ↙		

Hold 26	Skive 3	Niels Juulsgaard		
15 meter		Vester Hassing Skytteforening		BK1
		Nordjysk mesterskab 2019	Aalborg Skyttekreds	
Prøve		1:	9.2	→
		2:	10.2	←
		3:	10.0	↓
		4:	10.6x	→
		5:	10.1	↓
		6:	10.6x	→
		7:	10.6x	→
		8:	10.8x	↑
		Serie	79 (4x)	
		Total	0 (0x)	
20 Skud		1:	10.3	↑
		2:	10.6x	↑
		3:	10.6x	→
		4:	10.3	↑
		5:	10.8x	→
		6:	10.2	←
		7:	10.5x	→
		8:	10.9x	↓
		9:	10.6x	↓
		10:	10.7x	←
		Serie	100 (7x)	
		Total	100 (7x)	
20 Skud		11:	10.8x	↓
		12:	10.8x	→
		13:	10.8x	→
		14:	10.7x	↓
		15:	10.6x	↓
		16:	10.3	↓
		17:	10.5x	←
		18:	10.6x	↓
		19:	10.5x	↑
		20:	10.7x	↑
		Serie	100 (9x)	
		Total	200 (16x)	

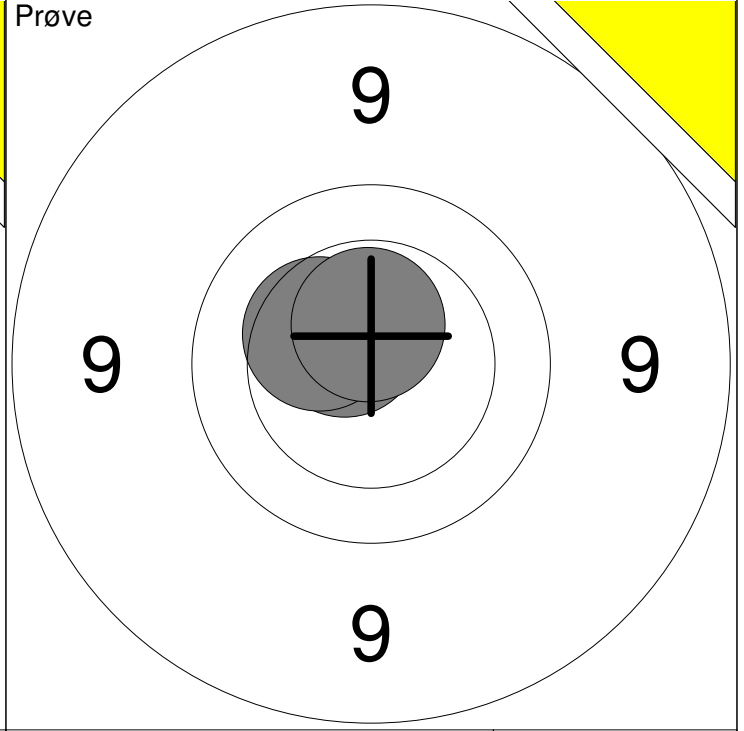
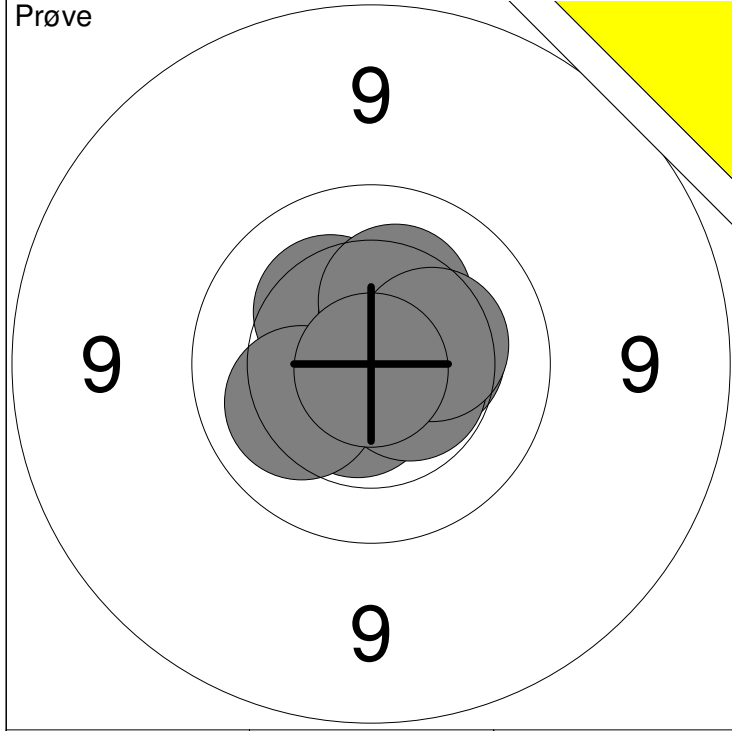

1: 10.6x ↗	6: 10.3 ↗	Serie 100 (4x)
2: 10.3 ↘	7: 10.4 →	
3: 10.6x ↙	8: 10.5x ↘	Total 0 (0x)
4: 10.2 ↖	9: 10.3 →	
5: 10.4 ↗	10: 10.9x ↓	

11: 10.6x ↖	Serie 30 (2x)
12: 10.4 ↖	
13: 10.6x ↑	Total 0 (0x)

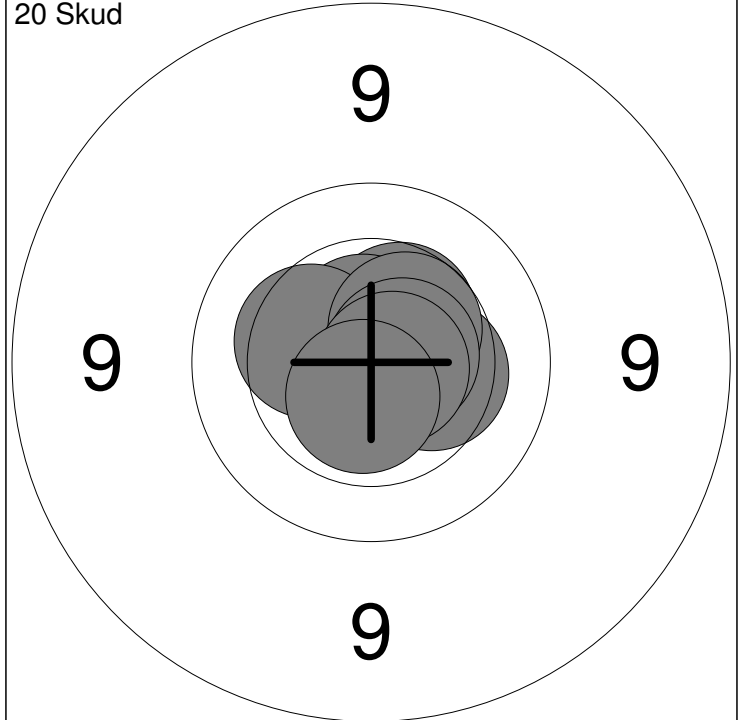
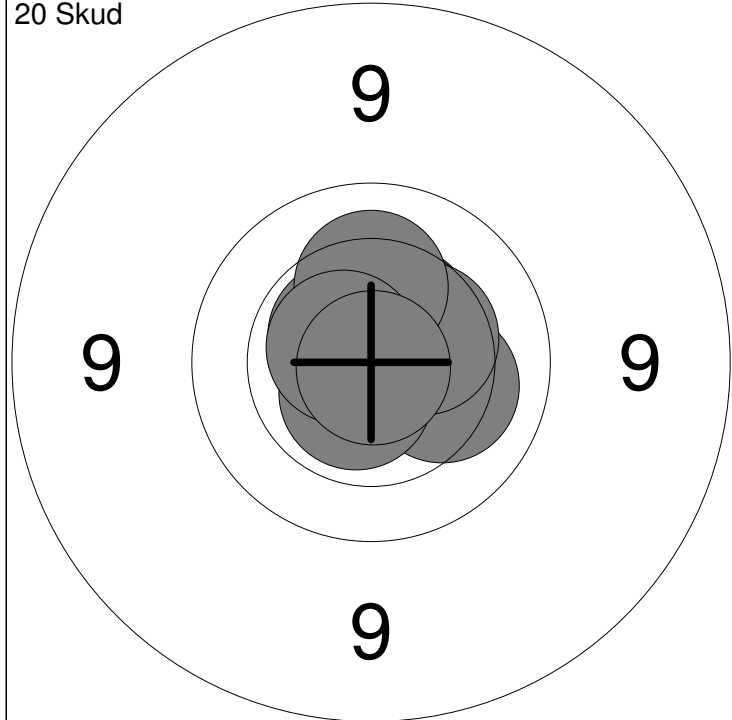

1: 10.2 →	6: 10.8x ↗	Serie 100 (6x)
2: 10.6x ↖	7: 10.4 →	
3: 10.6x ↙	8: 10.2 ↑	Total 100 (6x)
4: 10.5 ↗	9: 10.6x ↖	
5: 10.6x ↗	10: 10.9x ↓	

11: 10.4 ↗	16: 10.3 ↖	Serie 100 (6x)
12: 10.3 →	17: 10.5 ↗	
13: 10.6x ↗	18: 10.6x →	Total 200 (12x)
14: 10.9x ↗	19: 10.7x →	
15: 10.8x ↓	20: 10.6x ↓	

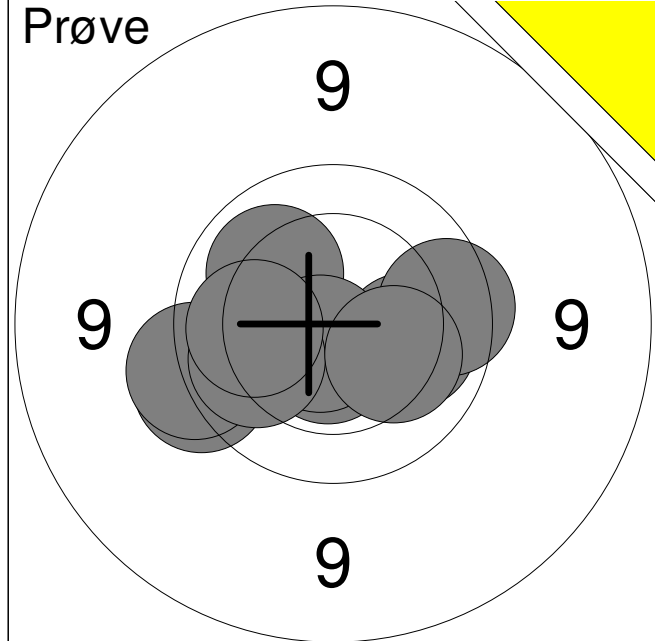

1:	9.6	↙
2:	9.6	↙
3:	10.1	→
4:	9.8	→
5:	10.6x	↓
6:	10.1	↗
7:	10.7x	↓
8:	10.0	↙
9:	10.1	↙
10:	10.2	↘
Serie		97 (2x)
Total		0 (0x)

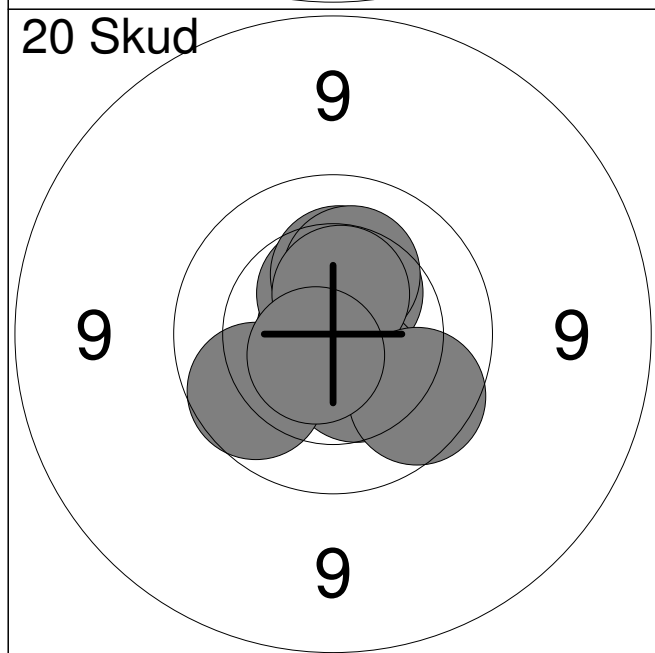

1:	10.9x	↙
2:	10.5	↑
3:	10.3	↑
4:	10.4	↗
5:	10.3	↑
6:	10.4	↓
7:	10.5x	↑
8:	9.9	↙
9:	9.9	↘
10:	10.6x	↘
Serie		98 (3x)
Total		98 (3x)

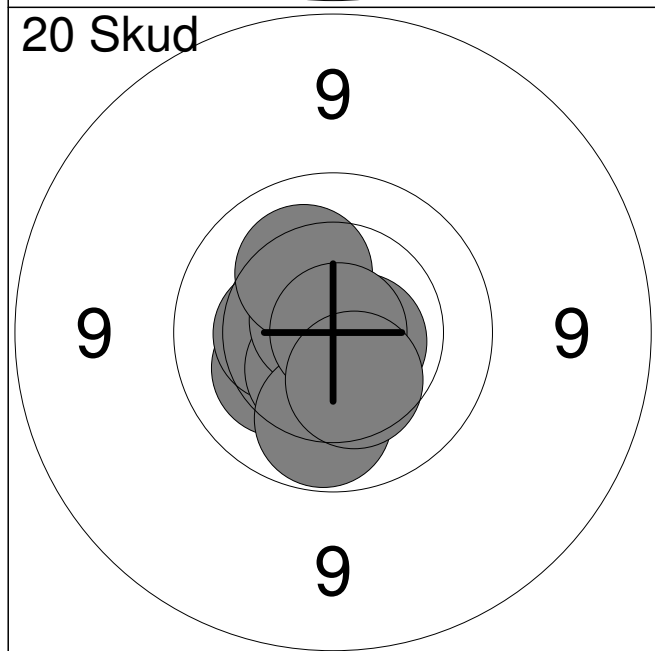

11:	10.2	↙
12:	10.3	↓
13:	10.7x	→
14:	10.4	↙
15:	10.5x	↓
16:	10.7x	↗
17:	10.0	↓
18:	10.2	↗
19:	10.9x	→
20:	10.4	↓
Serie		100 (4x)
Total		198 (7x)

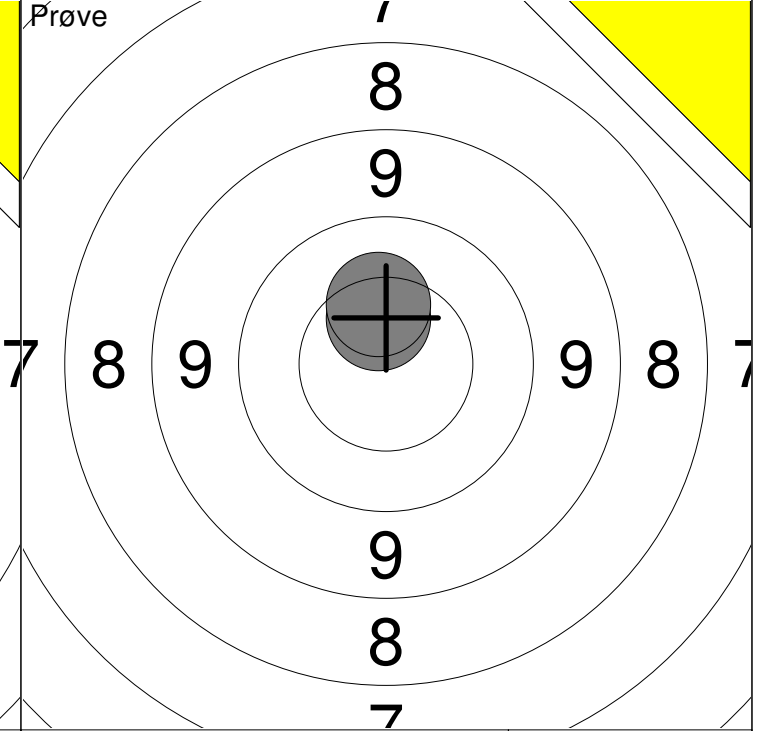
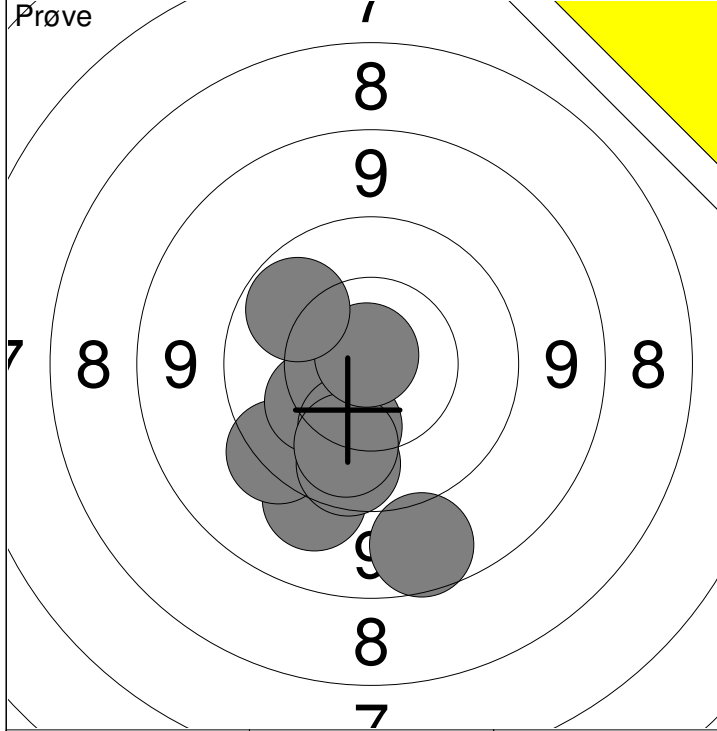

1: 9.4 ↓	6: 10.3 ↓	Serie 85 (1x)
2: 8.9 ↓	7: 10.1 ↓	
3: 9.6 ↙	9: 10.8x ↗	Total 0 (0x)
4: 9.9 ↓	10: 10.0 ↖	
5: 10.3 ↙		

11: 10.5 ↑	Serie 20 (0x)
13: 10.3 ↑	
	Total 0 (0x)

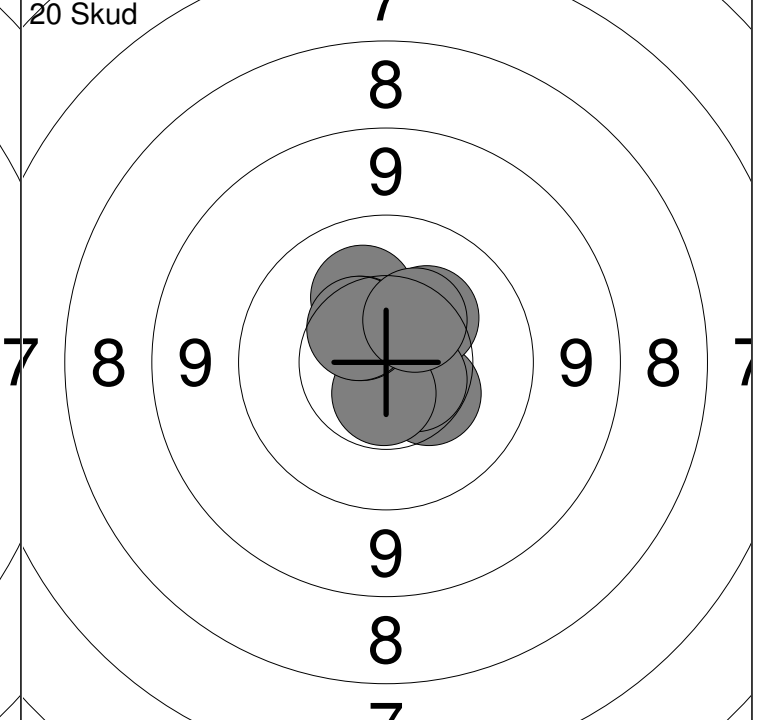
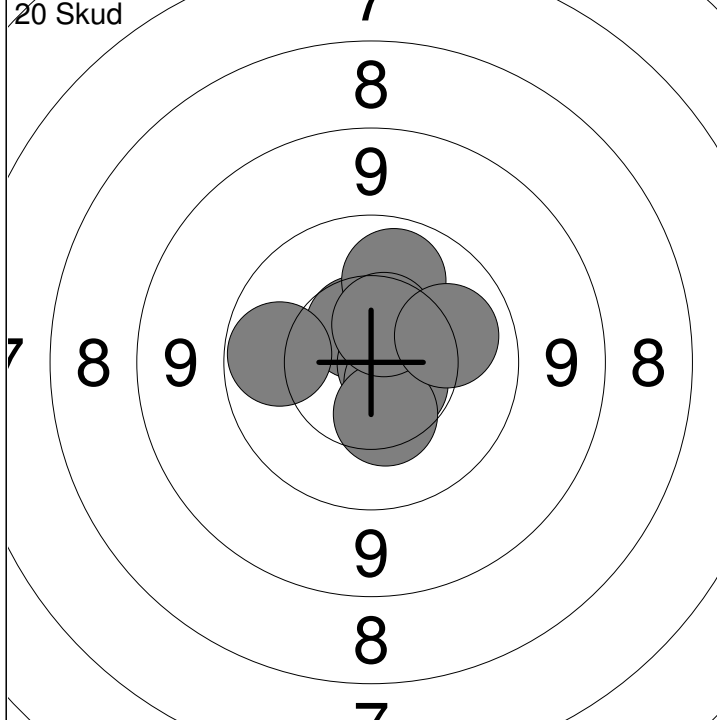

1: 10.6 ↗	6: 10.6x ↘	Serie 100 (3x)
2: 10.0 ↖	7: 10.1 ↗	
3: 10.6x ↗	8: 10.4 ↓	Total 100 (3x)
4: 10.8x →	9: 10.5 ↗	
5: 10.5 ↗	10: 10.1 →	

11: 10.8x ↗	16: 10.6x ↘	Serie 100 (3x)
12: 10.4 ↗	17: 10.6x ↓	
13: 10.4 ↘	18: 10.5 ↗	Total 200 (6x)
14: 10.2 ↗	19: 10.5 ↖	
15: 10.3 ↗	20: 10.4 ↗	

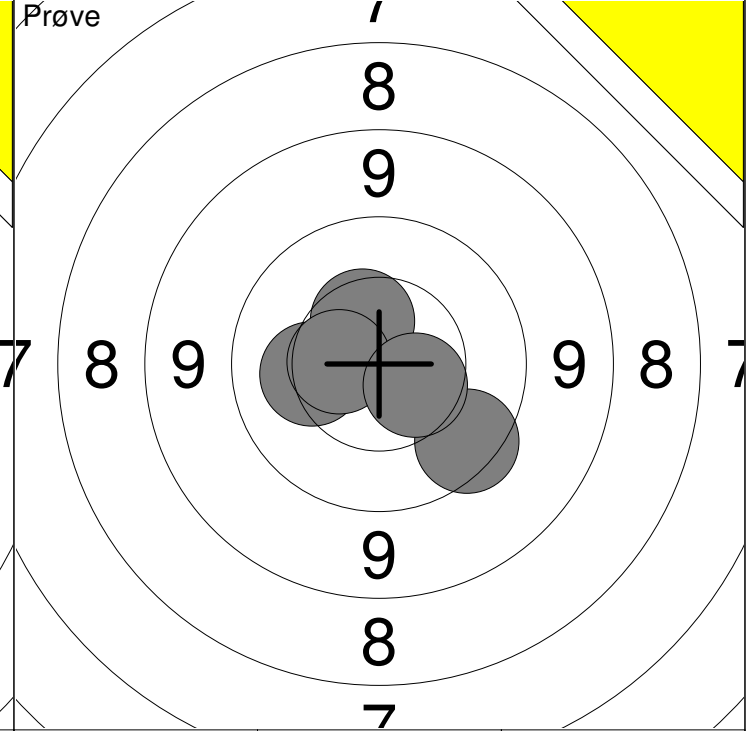
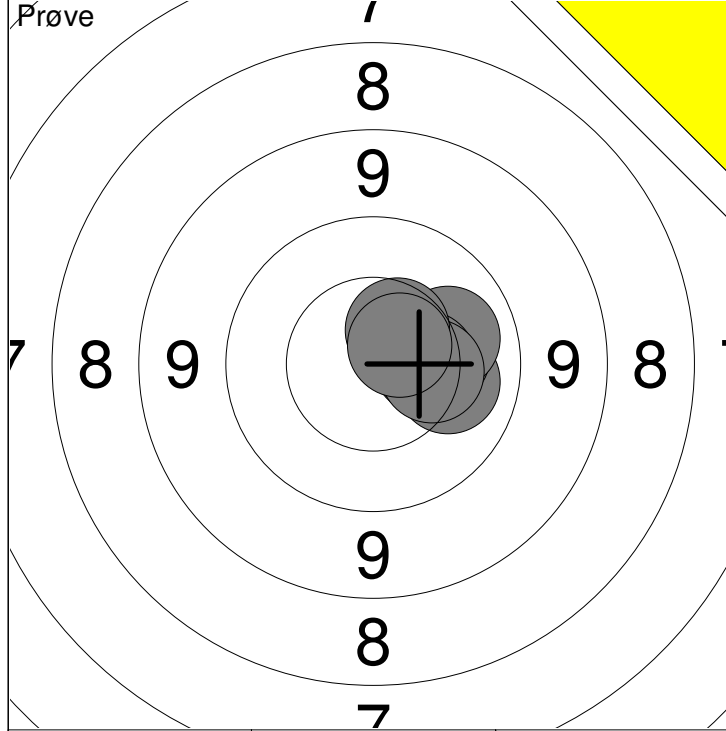

2: 10.1 →	9: 10.5 ↗	Serie	70 (1x)
3: 10.3 →	10: 10.6x ↗		
5: 10.1 →		Total	0 (0x)
6: 10.4 →			
7: 10.3 →			

11: 10.5 ↗	Serie	49 (0x)
12: 10.2 ←		
13: 10.5 ←	Total	0 (0x)
15: 9.7 ↘		
16: 10.5 ↘		

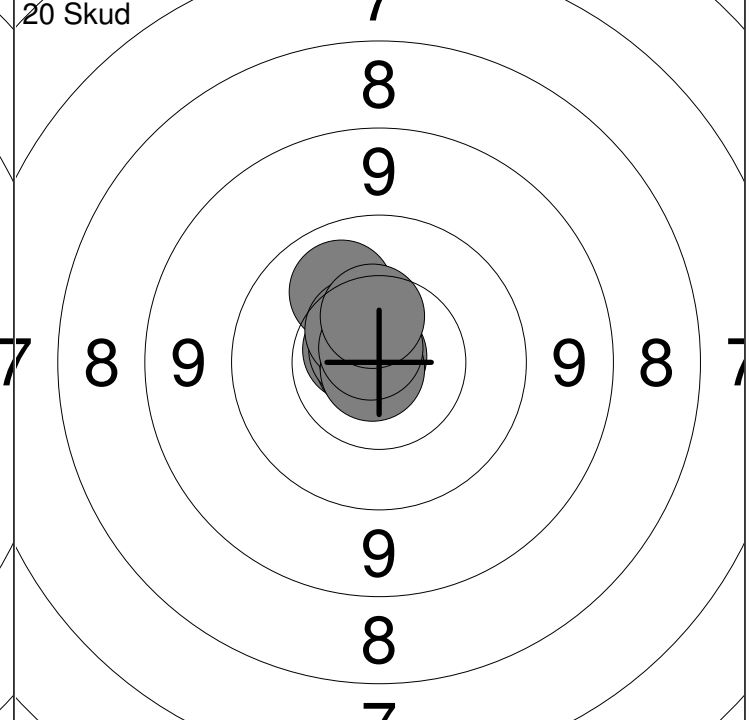
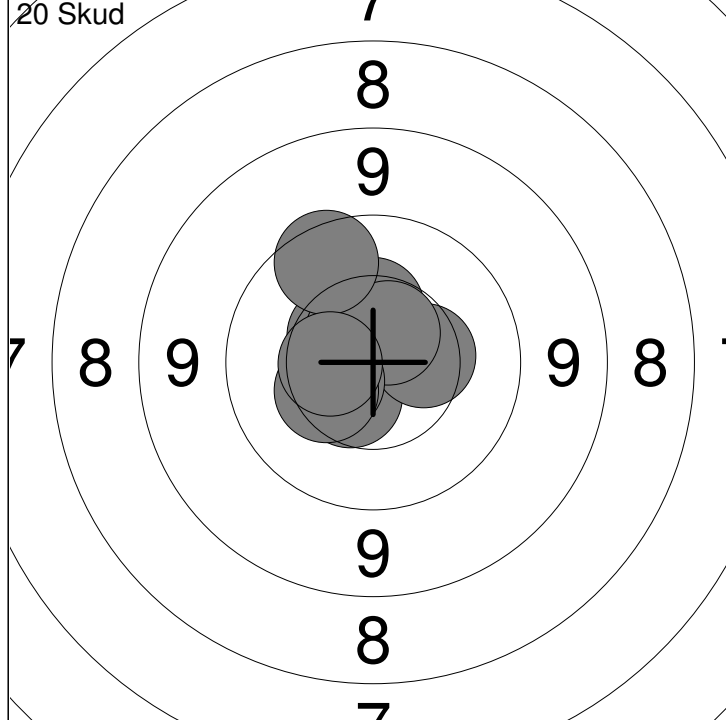

1: 10.5 ↖	6: 10.6x ↗	Serie	99 (2x)
2: 10.6x ↗	7: 10.5 ←		
3: 10.5 ↘	8: 9.8 ↗	Total	99 (2x)
4: 10.4 →	9: 10.4 ←		
5: 10.4 ↑	10: 10.5 ←		

11: 10.7x ↖	Serie	100 (7x)
12: 10.8x ←		
13: 10.7x ↗	Total	199 (9x)
14: 10.9x ↖		
15: 10.9x ↗		

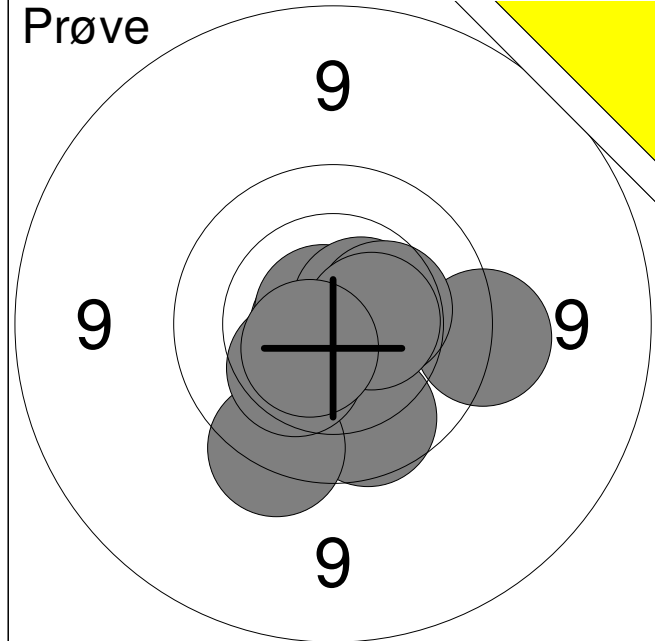

1:	9.9	↘
2:	9.6	→
3:	10.8x	←
4:	9.7	↘
5:	10.3	↘
6:	10.8x	↗
7:	10.6x	↗
8:	10.4	→
9:	10.5x	→
10:	10.6x	↙
Serie	97 (5x)	
Total	0 (0x)	

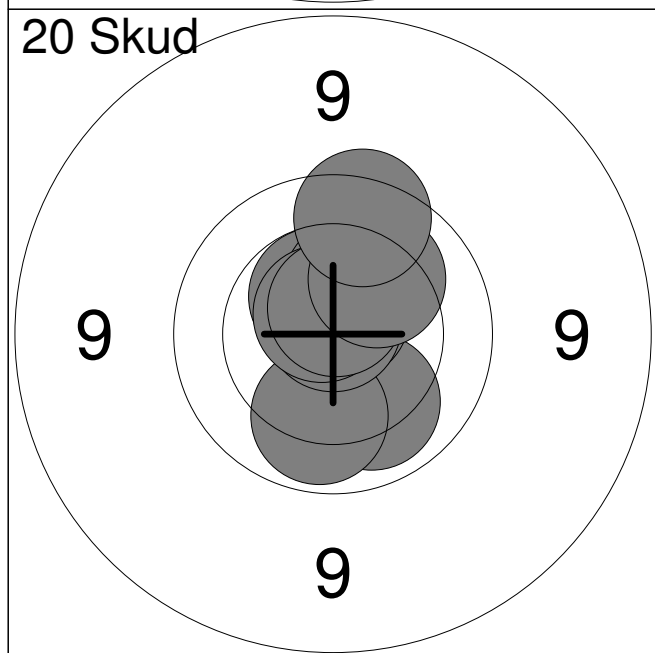

1:	10.1	↘
2:	10.7x	↗
3:	10.5x	↗
4:	10.4	↗
5:	10.0	↘
6:	10.8x	↑
7:	10.7x	↗
8:	10.7x	↑
9:	10.2	↗
10:	9.8	↑
Serie	99 (5x)	
Total	99 (5x)	

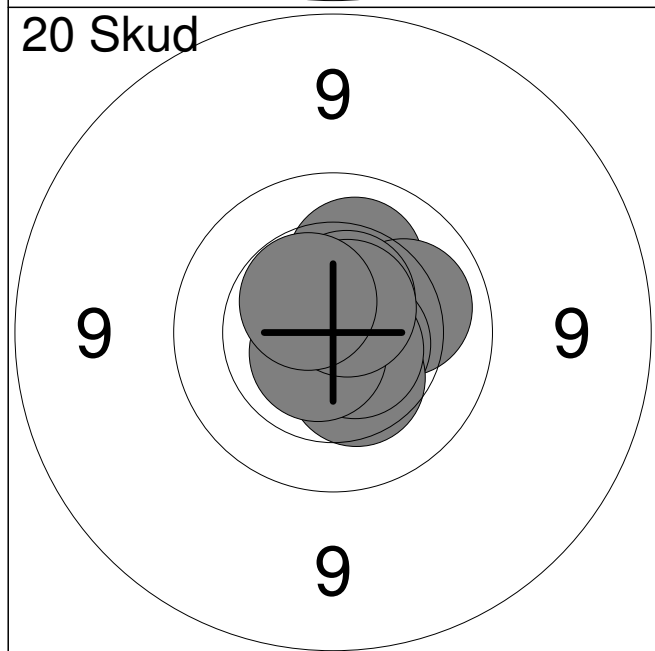

11:	10.2	↑
12:	10.1	→
13:	10.6x	↘
14:	10.6x	→
15:	10.4	↘
16:	10.6x	↘
17:	10.7x	↘
18:	10.6x	↑
19:	10.6x	↗
20:	10.5x	↗
Serie	100 (7x)	
Total	199 (12x)	

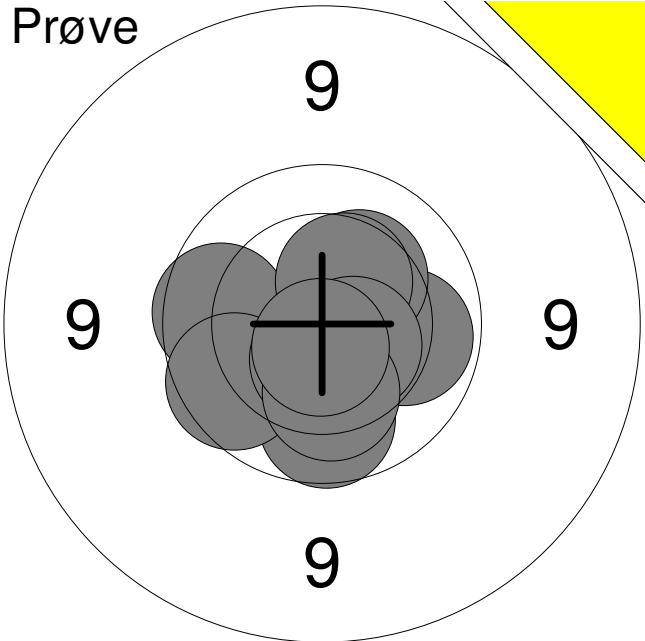
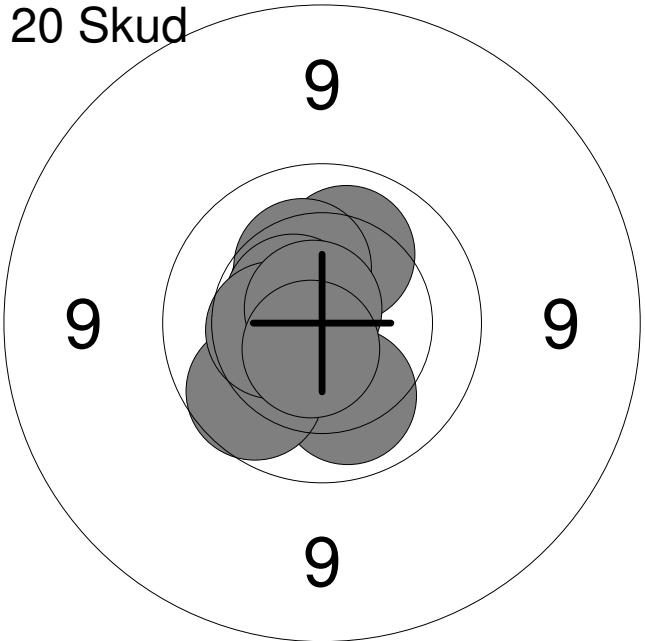
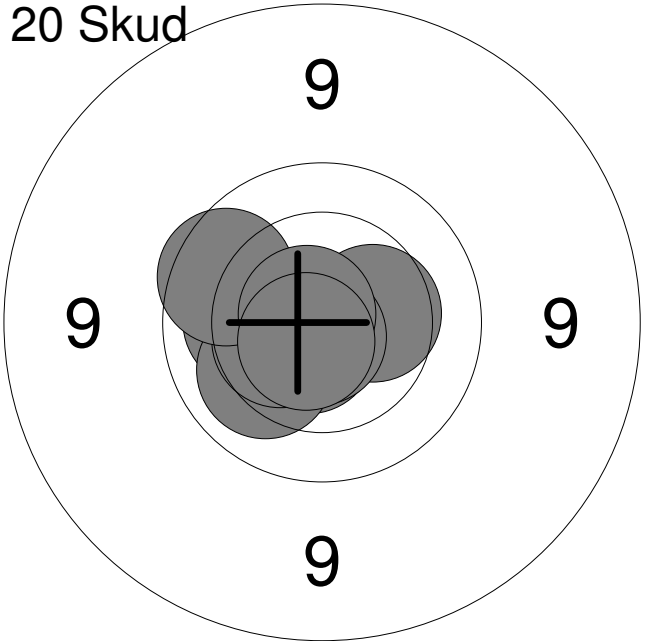
Hold	Skive	Kasper_Rebelski	
26	9	Vilsted Skytteforening	BK2
15 meter		Nordjysk mesterskab 2019	Aalborg Skyttekreds
Prøve		1: 9.9	↓
		2: 10.0	→
		3: 10.3	↗
		4: 9.9	←
		5: 10.4	↗
		6: 9.9	←
		7: 10.5x	↘
		8: 10.6x	↓
		9: 10.2	↓
		10: 10.7x	↓
		Serie	97 (3x)
		Total	0 (0x)
20 Skud		1: 10.1	↓
		2: 10.8x	←
		3: 9.9	↙
		4: 10.5	↗
		5: 10.1	↗
		6: 10.3	↗
		7: 10.6x	↗
		8: 10.4	←
		9: 10.8x	↗
		10: 10.6x	↓
		Serie	99 (4x)
		Total	99 (4x)
20 Skud		11: 10.7x	↙
		12: 10.2	←
		13: 10.2	←
		14: 10.4	→
		15: 10.1	↙
		16: 10.8x	↓
		17: 10.5	←
		18: 9.8	←
		19: 10.8x	↙
		20: 10.7x	↙
		Serie	99 (4x)
		Total	198 (8x)

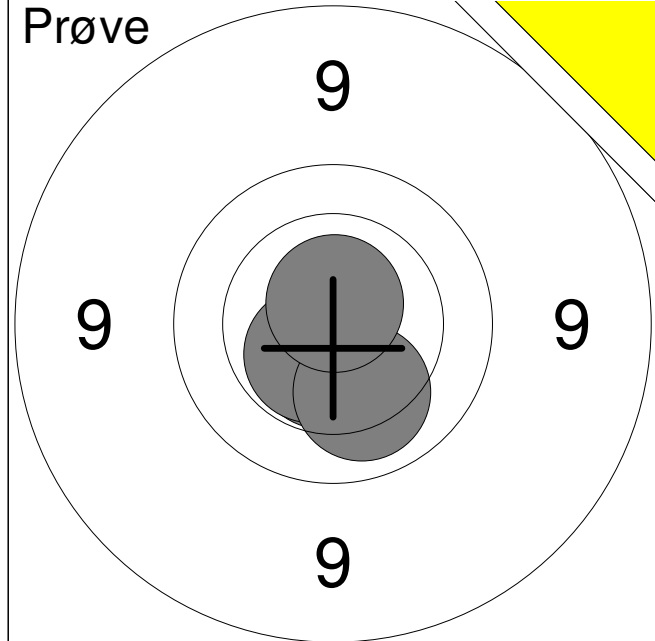

1:	10.5x	↓
2:	10.5x	↙
3:	10.1	↓
4:	10.7x	↑
Serie		40 (3x)
Total		0 (0x)

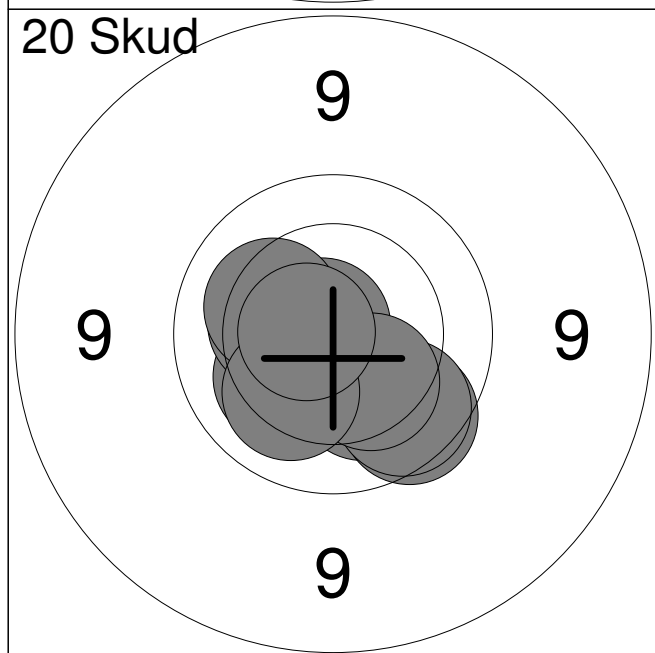

1:	10.2	↙
2:	10.3	←
3:	10.8x	↗
4:	10.2	↓
5:	9.8	↓
6:	9.9	↓
7:	10.3	↓
8:	10.2	↗
9:	10.2	↓
10:	10.7x	←
Serie		98 (2x)
Total		98 (2x)

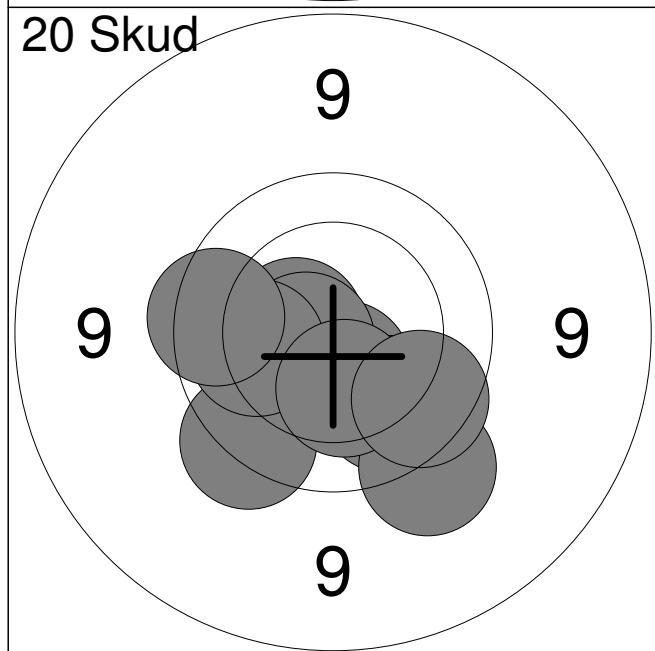

11:	10.5x	↓
12:	10.5x	←
13:	10.6x	←
14:	9.7	↓
15:	10.1	←
16:	10.0	↓
17:	9.8	←
18:	9.5	↓
19:	10.3	↓
20:	9.8	↓
Serie		96 (3x)
Total		194 (5x)

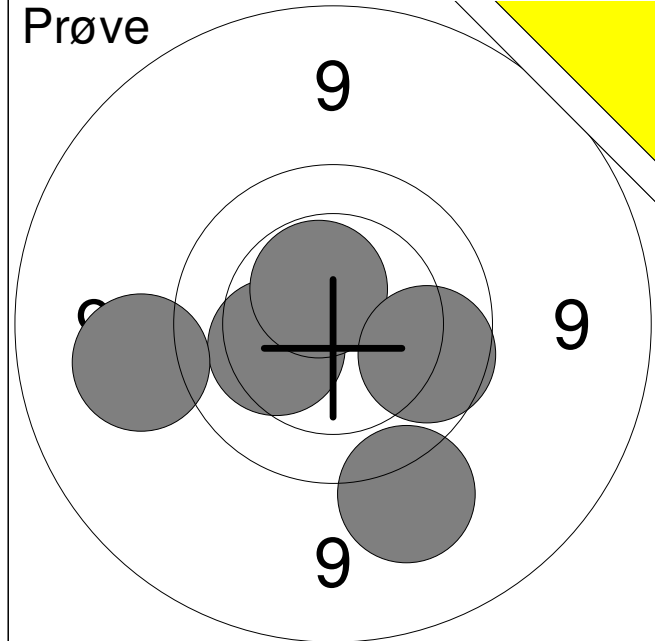

1:	10.3	←
2:	9.4	↓
3:	9.3	←
4:	10.5x	↑
5:	9.9	→
Serie		47 (1x)
Total		0 (0x)

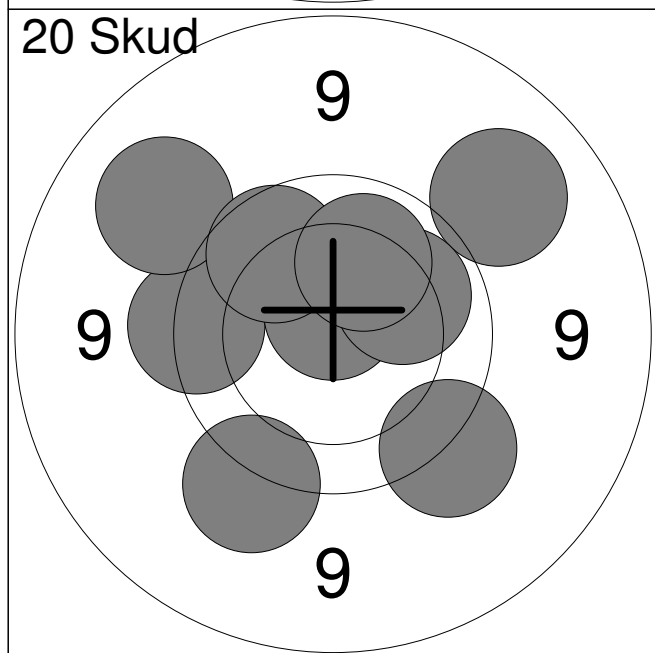

1:	9.4	↓
2:	9.7	←
3:	9.5	↓
4:	9.2	↗
5:	10.3	↑
6:	9.2	↗
7:	10.7x	↑
8:	10.1	↗
9:	9.9	↗
10:	10.1	↑
Serie		94 (1x)
Total		94 (1x)

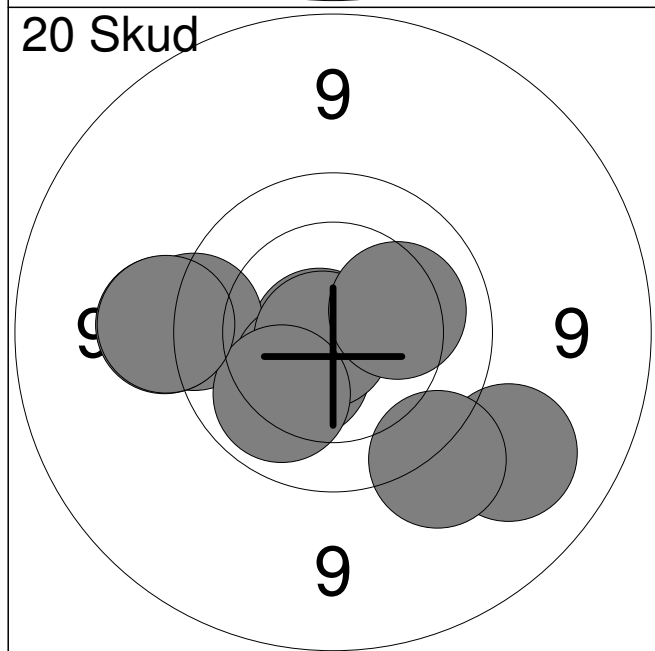

11:	9.2	↓
12:	10.8x	←
13:	9.6	←
14:	10.4	↓
15:	10.8x	←
16:	10.1	↓
17:	9.5	↓
18:	9.5	←
19:	9.5	←
20:	10.2	↗
Serie		95 (2x)
Total		189 (3x)

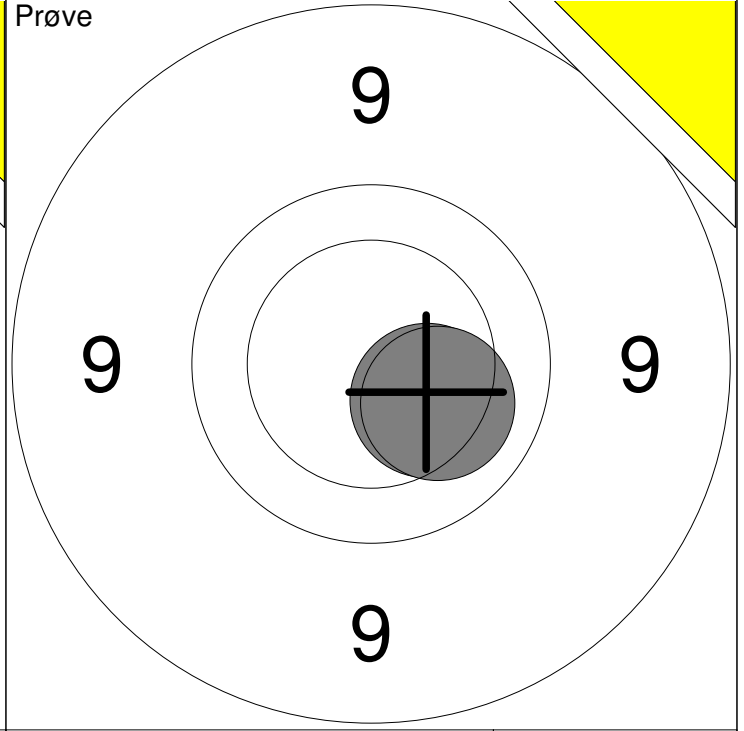
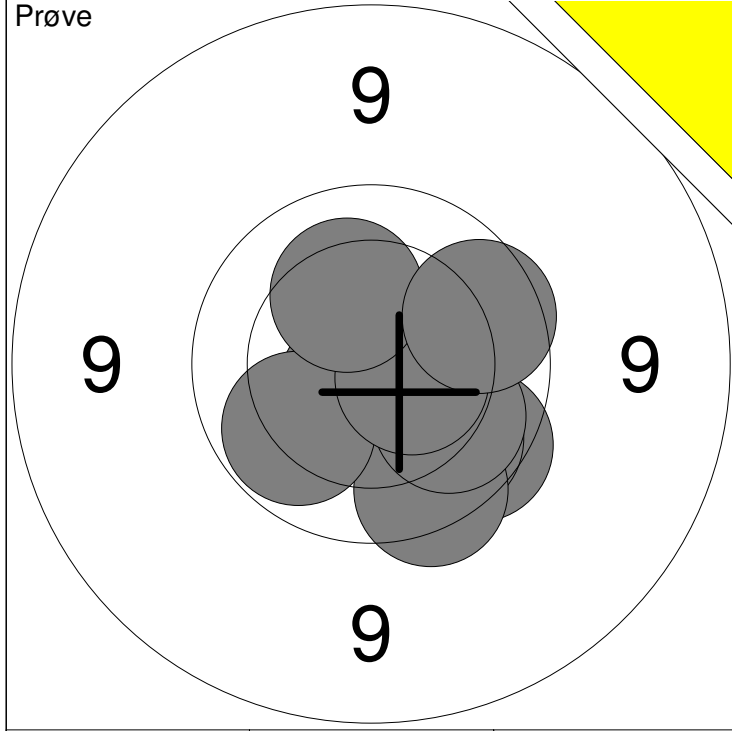

1: 9.8 ↘	6: 10.0 ↘	Serie 96 (3x)
2: 10.7x ↙	7: 10.0 ↙	
3: 10.7x ↘	8: 10.5x ↘	Total 0 (0x)
4: 9.9 ↘	9: 10.2 ↗	
5: 9.7 ↘	10: 9.9 ↗	

11: 10.3 ↘	Serie 20 (0x)
12: 10.2 ↘	
Total 0 (0x)	

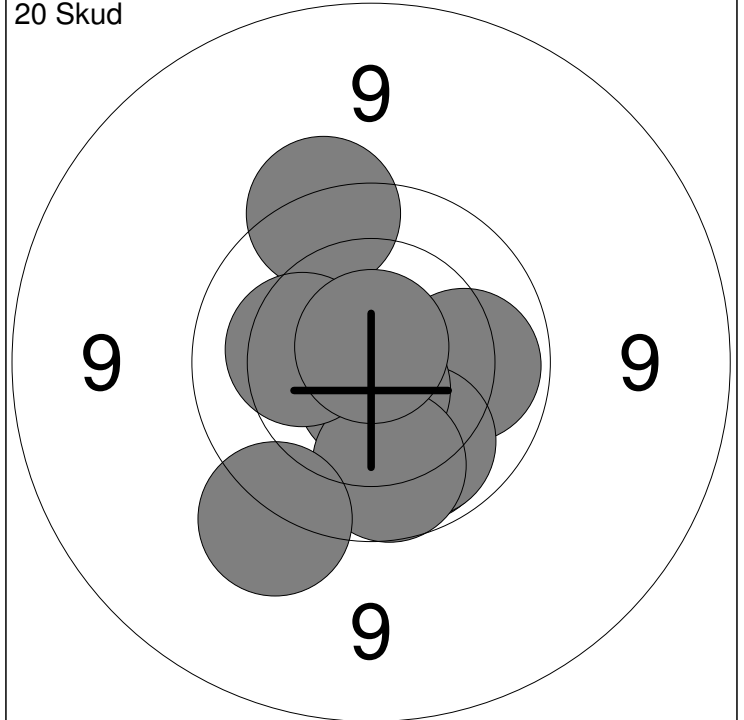
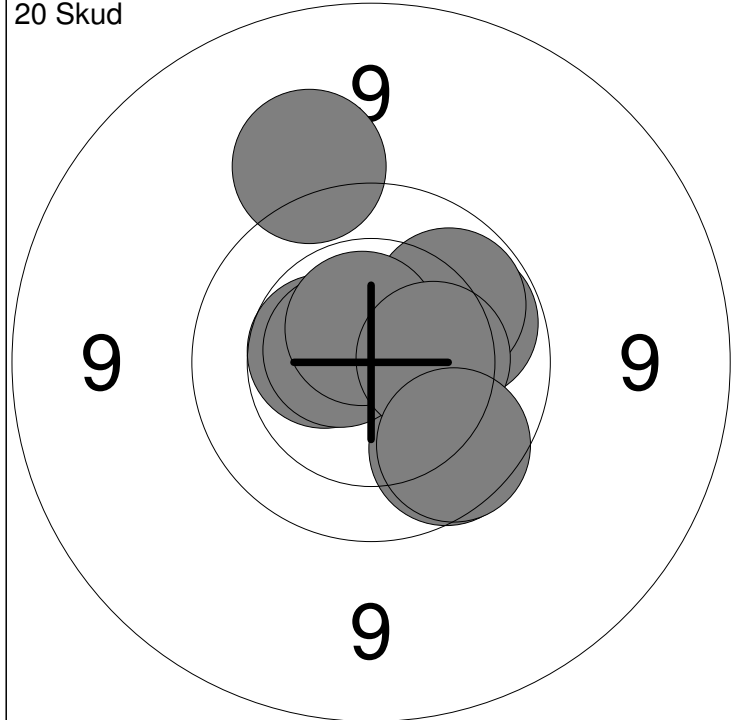

1: 10.5 ←	6: 10.6x ↗	Serie 97 (3x)
2: 9.4 ↗	7: 10.6x ↖	
3: 9.9 ↘	8: 10.6x ↗	Total 97 (3x)
4: 10.0 ↗	9: 10.3 →	
5: 10.0 ↗	10: 9.9 ↘	

11: 10.0 ↘	16: 10.7x ↘	Serie 97 (2x)
12: 10.0 →	17: 9.9 ↘	
13: 9.6 ↗	18: 10.3 ←	Total 194 (5x)
14: 10.2 ↘	19: 10.8x ↗	
15: 10.0 ↘	20: 9.5 ↘	

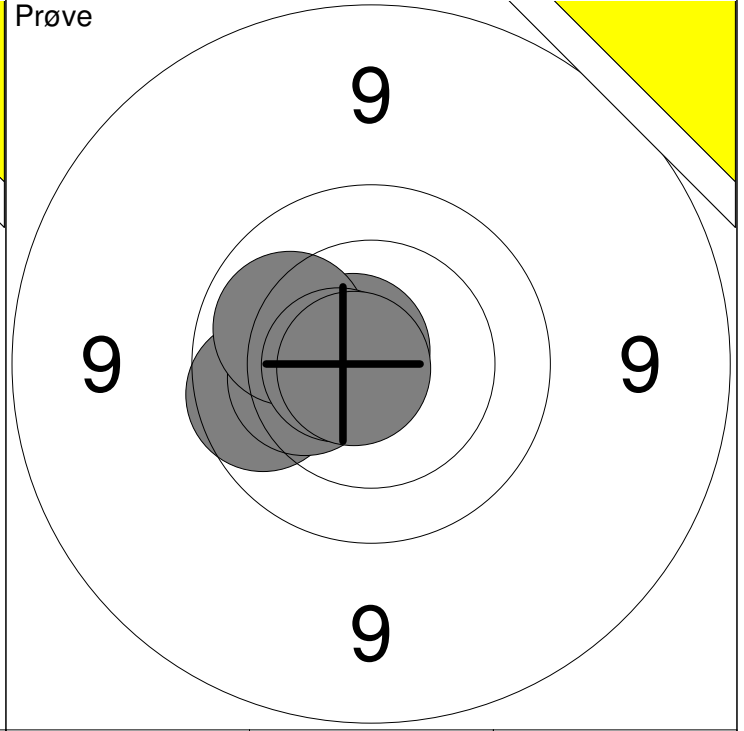
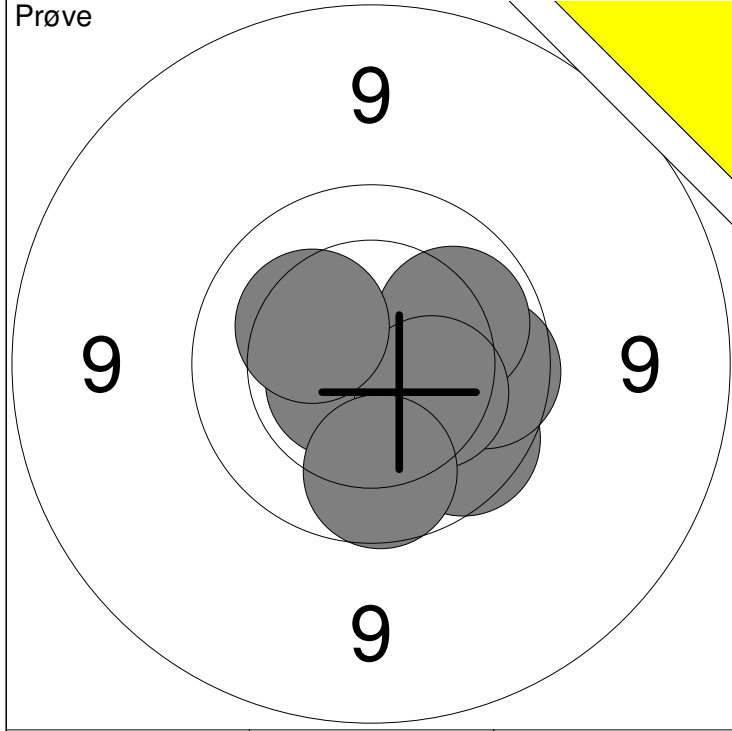

1: 10.6x ↙	8: 10.3 →	Serie 77 (1x)
3: 10.0 ↘	9: 10.3 ↖	
4: 9.9 ↘	10: 9.9 ↓	Total 0 (0x)
6: 9.9 →		
7: 10.1 ↗		

11: 10.7x ↖	16: 10.8x ←	Serie 59 (3x)
12: 9.9 ←		
13: 10.3 ←		Total 0 (0x)
14: 10.1 ↖		
15: 10.6x ←		

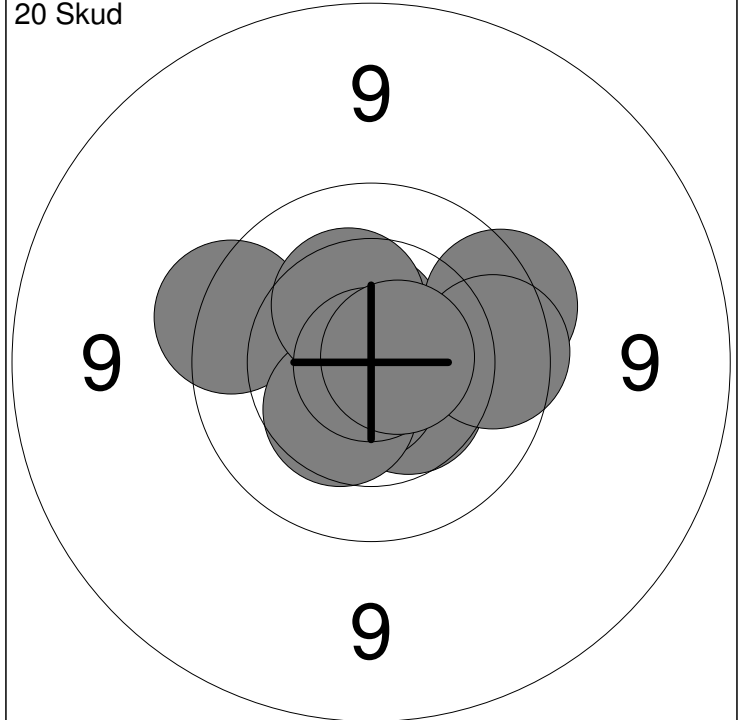
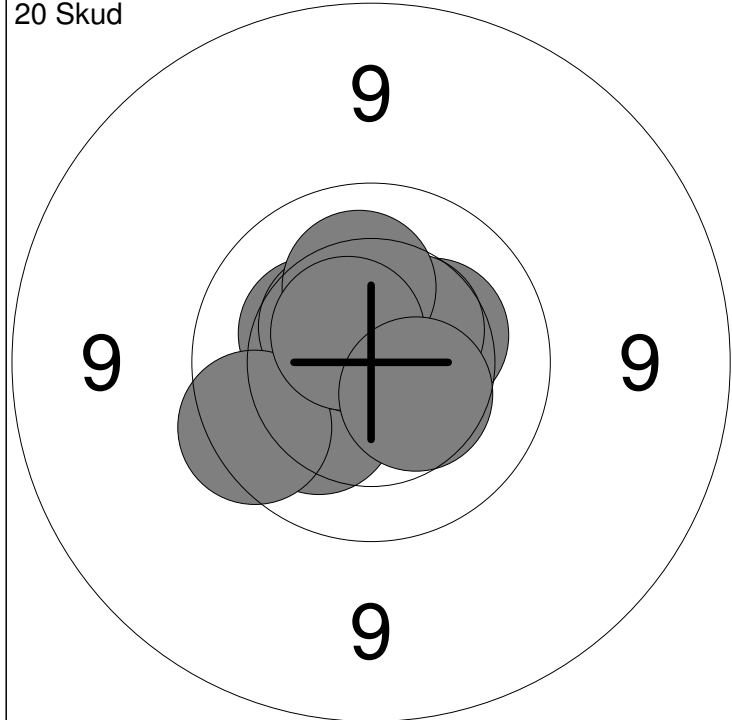

1: 10.3 ↗	6: 10.5 ↖	Serie 99 (2x)
2: 10.2 ↘	7: 10.2 ↑	
3: 10.3 ↖	8: 9.8 ←	Total 99 (2x)
4: 10.7x ↑	9: 10.6x ↖	
5: 10.5 ↗	10: 10.4 ↘	

11: 10.6x ↑	16: 10.4 ↘	Serie 97 (4x)
12: 9.7 ←	17: 9.8 →	
13: 9.7 ↗	18: 10.3 ↖	Total 196 (6x)
14: 10.5 ↘	19: 10.9x ↓	
15: 10.7x ↓	20: 10.7x →	

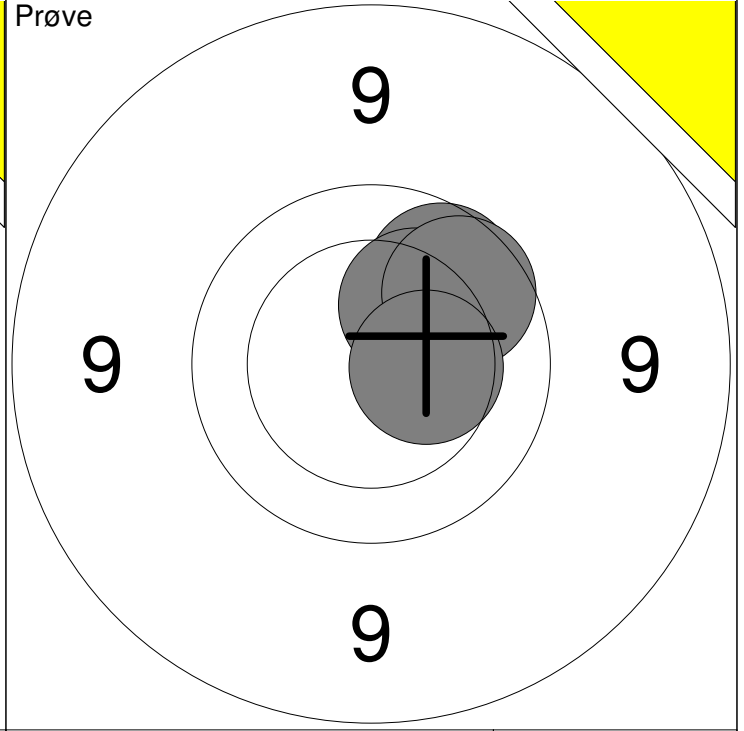
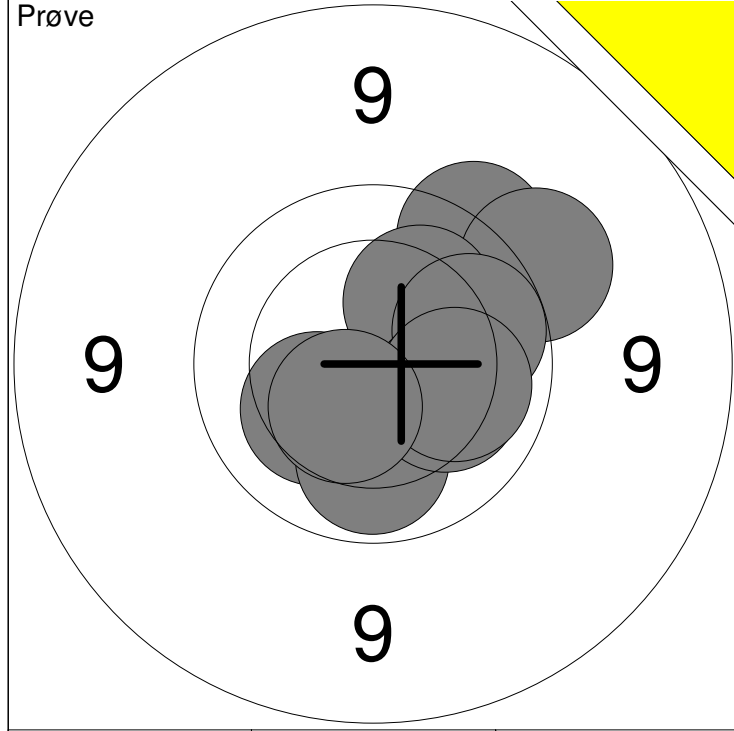

1: 9.6 ↗	7: 10.0 ↓	Serie	88 (0x)
3: 9.5 ↗	8: 10.2 →		
4: 10.2 ↗	9: 10.1 →	Total	0 (0x)
5: 10.0 →	10: 10.5 ↘		
6: 10.2 ↙			

11: 9.9 ↗	Serie	38 (0x)
12: 10.2 ↗		
13: 9.9 ↗	Total	0 (0x)
14: 10.4 →		

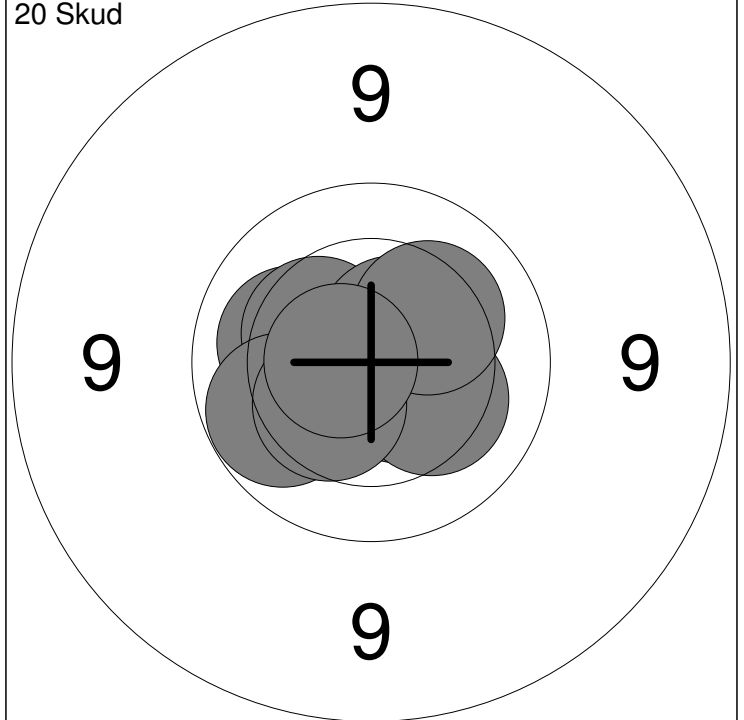
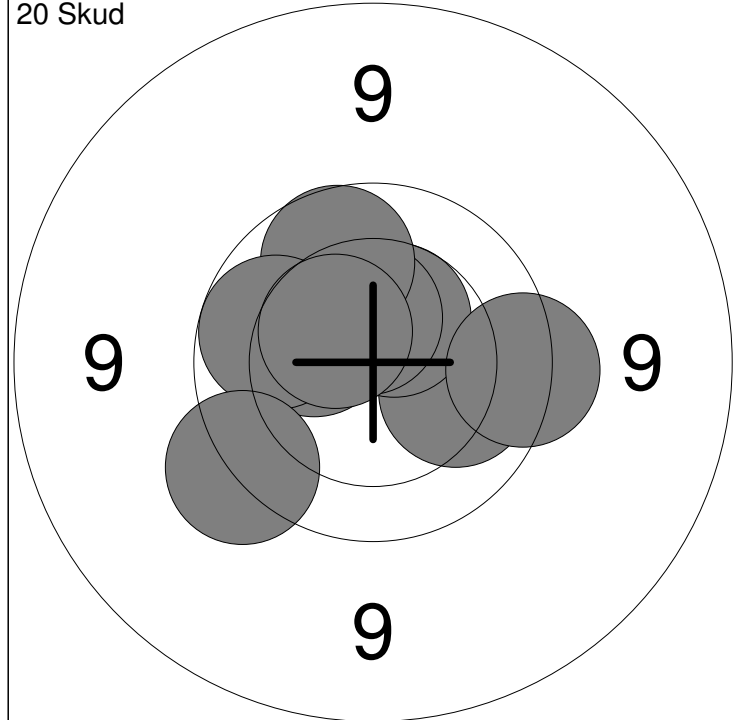

1: 10.1 →	6: 10.5x ↑	Serie	96 (1x)
2: 10.1 ↖	7: 9.9 ↑		
3: 10.5 ↗	8: 9.9 ←	Total	96 (1x)
4: 9.7 →	9: 10.5 ↖		
5: 10.3 ↖	10: 9.6 ↘		

11: 10.2 ↖	16: 10.3 →	Serie	100 (4x)
12: 10.4 ↖	17: 10.2 ↗		
13: 10.6x ↘	18: 10.0 ←	Total	196 (5x)
14: 10.6x →	19: 10.4 ↘		
15: 10.6x ↗	20: 10.7x ←		

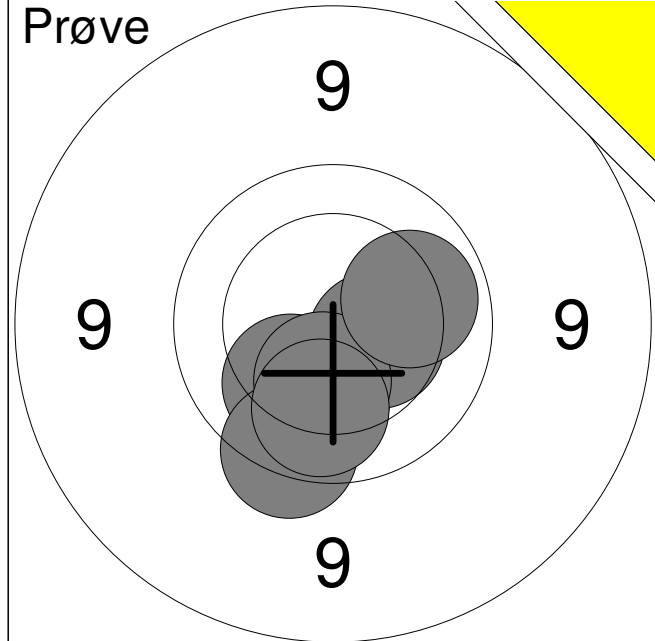

1:	10.2	↓
2:	10.2	↙
3:	9.7	↓
4:	10.4	→
5:	10.3	↓
6:	10.1	→
7:	10.0	↓
Serie		69 (0x)
Total		0 (0x)

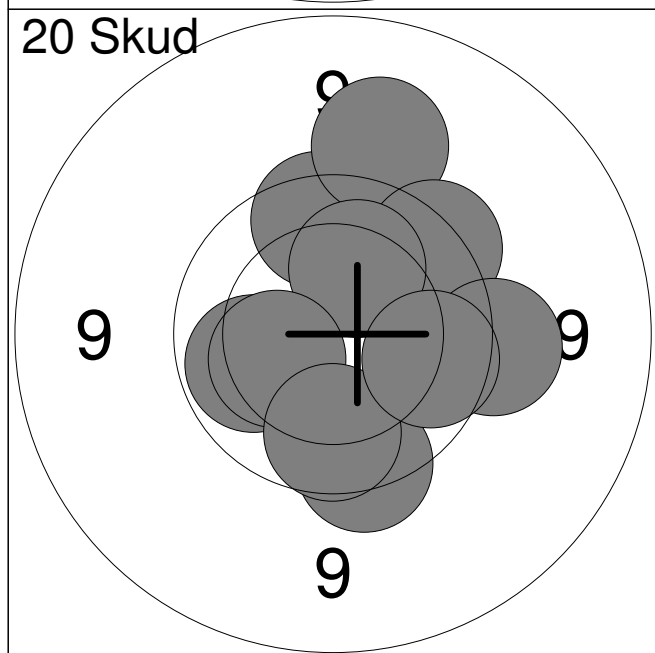

1:	9.8	↑
2:	9.3	↑
3:	9.7	↗
4:	10.0	←
5:	10.2	↑
6:	10.3	←
7:	9.7	↓
8:	9.9	↓
9:	9.5	→
10:	9.9	→
Serie		93 (0x)
Total		93 (0x)

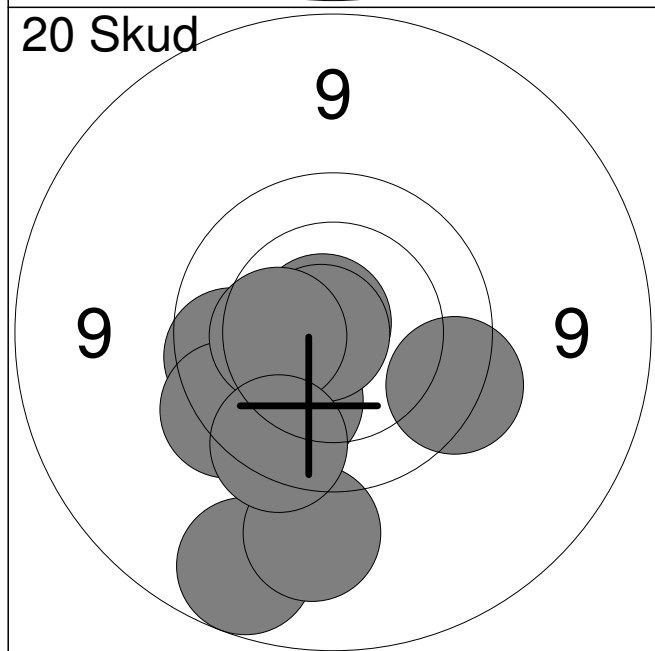

11:	9.7	→
12:	10.8x	↖
13:	9.0	↓
14:	10.1	↓
15:	10.8x	←
16:	9.9	←
17:	9.7	↙
18:	10.3	←
19:	9.3	↓
20:	9.7	↓
Serie		94 (2x)
Total		187 (2x)

Hold 27	Skive 4	Emil Hedemann	
15 meter		Vester Hassing Skytteforening	J2
		Nordjysk mesterskab 2019	Aalborg Skyttekreds
Prøve		1: 10.0 →	
		2: 10.5 ↗	
		3: 10.1 ↓	
		4: 9.9 ↓	
		5: 10.0 ↙	
		6: 9.8 ↑	
		7: 10.8x ↓	
		8: 10.9x ←	
		Serie	78 (2x)
		Total	0 (0x)
20 Skud		1: 10.4 ↑	
		2: 10.2 ←	
		3: 10.6x ↗	
		4: 10.3 ↗	
		5: 10.2 ↑	
		6: 10.7x ↑	
		7: 10.3 →	
		8: 10.6x ↓	
		9: 10.3 ←	
		10: 10.1 ↗	
		Serie	100 (3x)
		Total	100 (3x)
20 Skud		11: 10.5 ↑	
		12: 10.6x ↗	
		13: 9.9 ↗	
		14: 10.3 ↗	
		15: 10.1 ↑	
		16: 9.9 ←	
		17: 10.2 ↑	
		18: 10.4 ↗	
		19: 9.8 ↑	
		20: 10.5 ↑	
		Serie	97 (1x)
		Total	197 (4x)

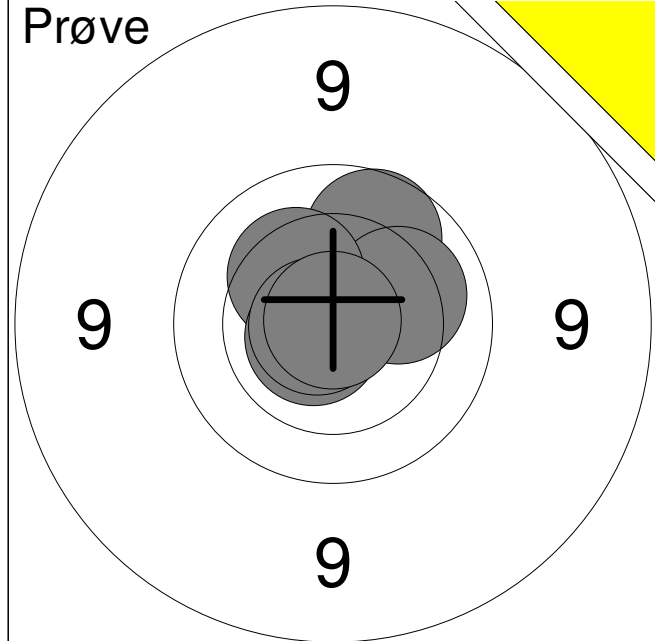

1:	9.9	↗
2:	10.2	→
3:	10.3	↖
4:	10.7x	←
5:	10.8x	←
6:	10.9x	↑
Serie		59 (3x)
Total		0 (0x)

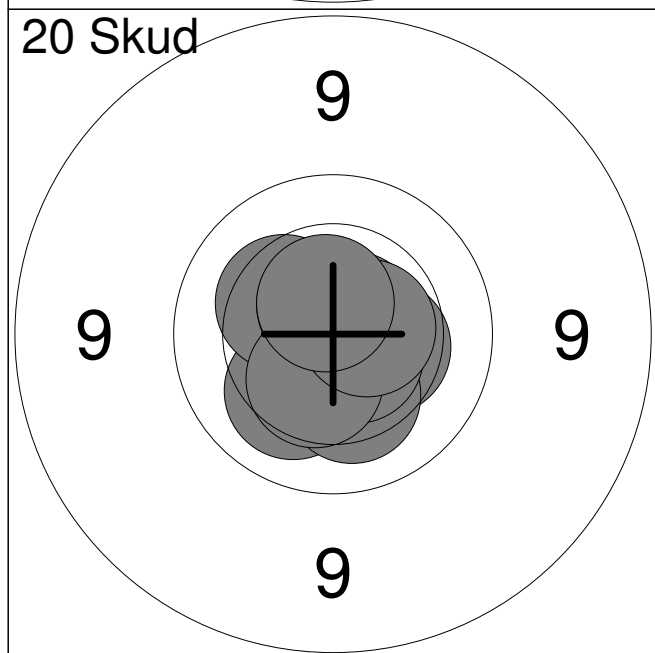

1:	10.4	→
2:	10.7x	↗
3:	10.2	↘
4:	10.3	↘
5:	10.3	↖
6:	10.6x	↑
7:	10.6x	↘
8:	10.4	↘
9:	10.6x	→
10:	10.6x	↑
Serie		100 (5x)
Total		100 (5x)

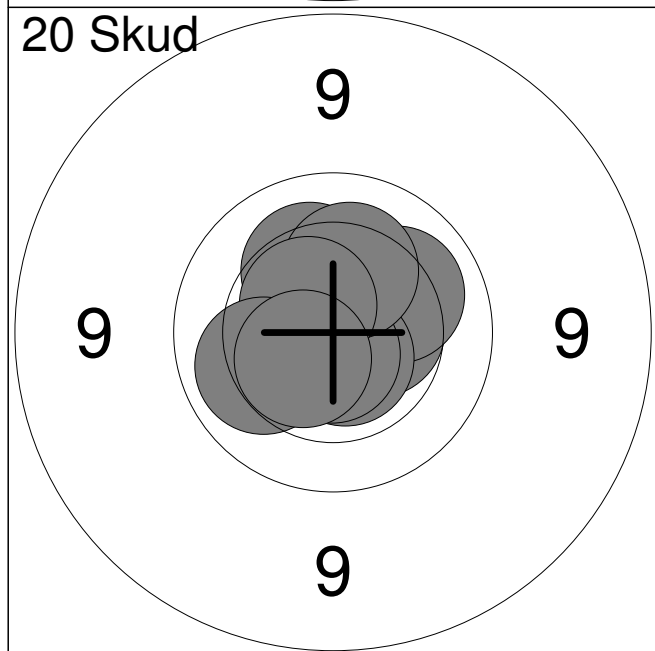

11:	10.7x	↖
12:	10.5	→
13:	10.1	↗
14:	10.2	↑
15:	10.6x	↘
16:	10.7x	↘
17:	10.2	↑
18:	10.5x	↖
19:	10.1	←
20:	10.5x	↘
Serie		100 (5x)
Total		200 (10x)

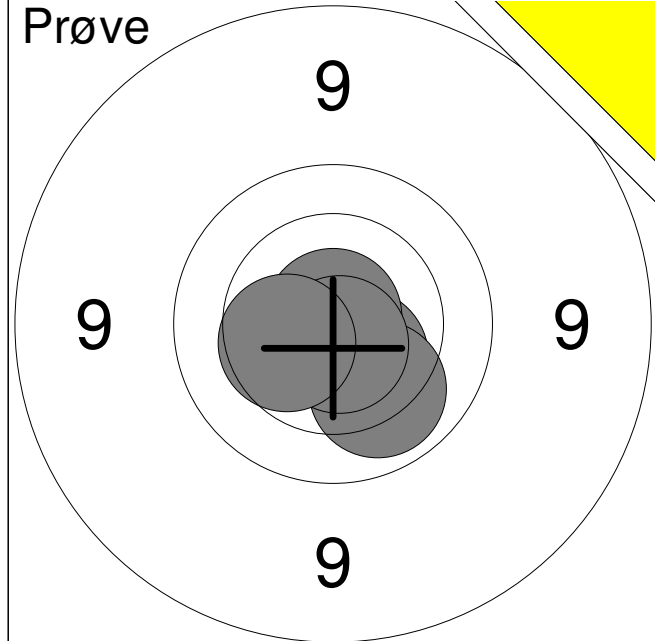

1:	10.5	↘
2:	10.1	↘
3:	10.9x	↑
4:	10.7x	↘
5:	10.4	←
Serie		50 (2x)
Total		0 (0x)

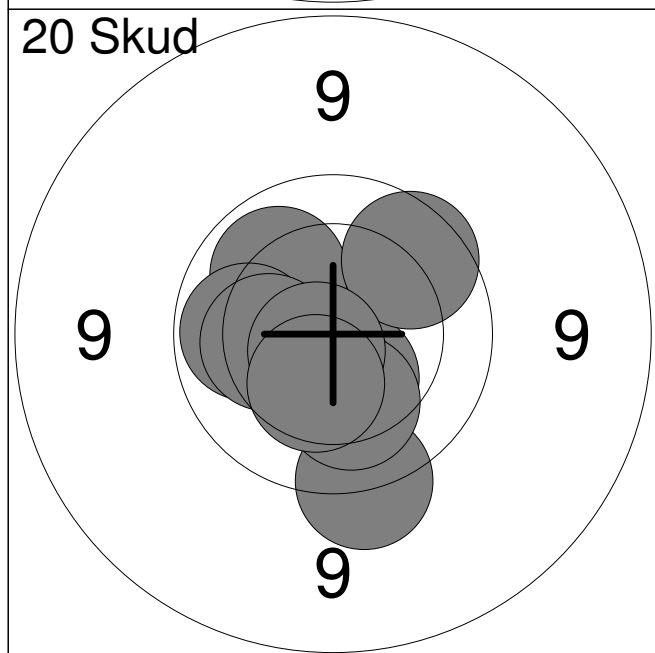

1:	10.4	↘
2:	10.1	↗
3:	10.0	←
4:	10.2	←
5:	10.5	↘
6:	9.6	↘
7:	9.8	↗
8:	10.2	↘
9:	10.7x	↘
10:	10.4	↘
Serie		98 (1x)
Total		98 (1x)

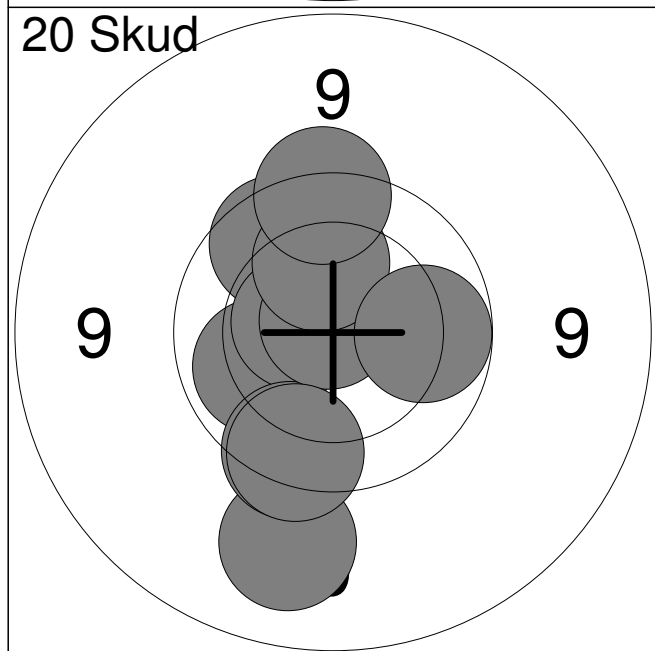

11:	10.1	←
12:	9.9	↗
13:	10.6x	←
14:	9.2	↘
15:	9.7	↘
16:	10.8x	↗
17:	9.7	↘
18:	10.2	↑
19:	9.7	↑
20:	10.0	→
Serie		95 (2x)
Total		193 (3x)

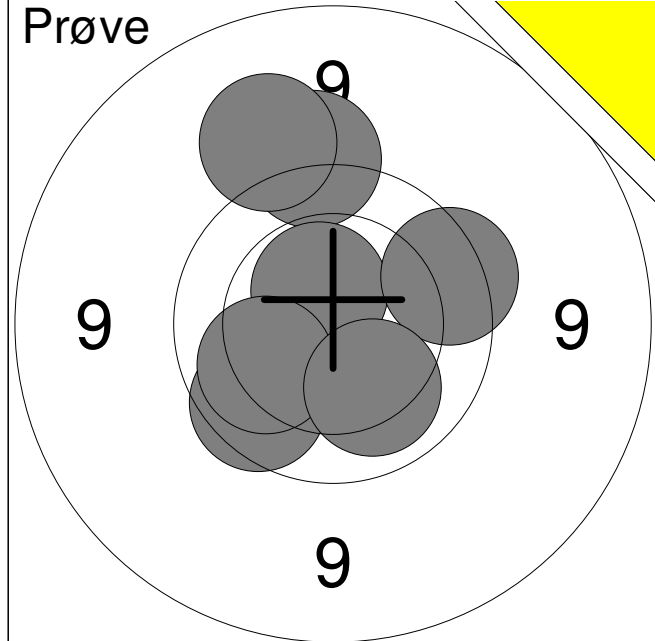

1:	9.5	↑
2:	9.8	↙
3:	10.6x	↑
4:	10.1	↙
5:	9.7	→
6:	9.3	↑
7:	10.1	↘
Serie		66 (1x)
Total		0 (0x)

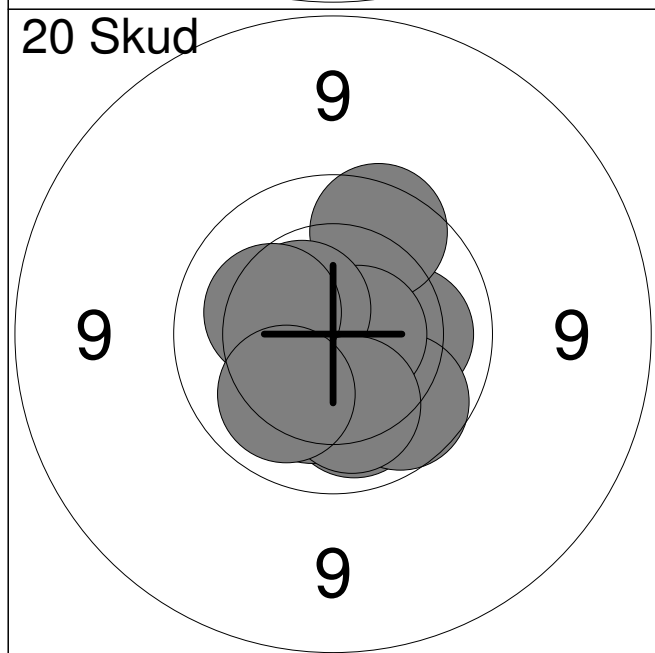

1:	10.2	→
2:	10.1	↘
3:	9.8	↑
4:	9.9	↘
5:	10.7x	→
6:	10.5x	↑
7:	10.2	↘
8:	10.1	↘
9:	10.2	←
10:	10.1	↘
Serie		98 (2x)
Total		98 (2x)

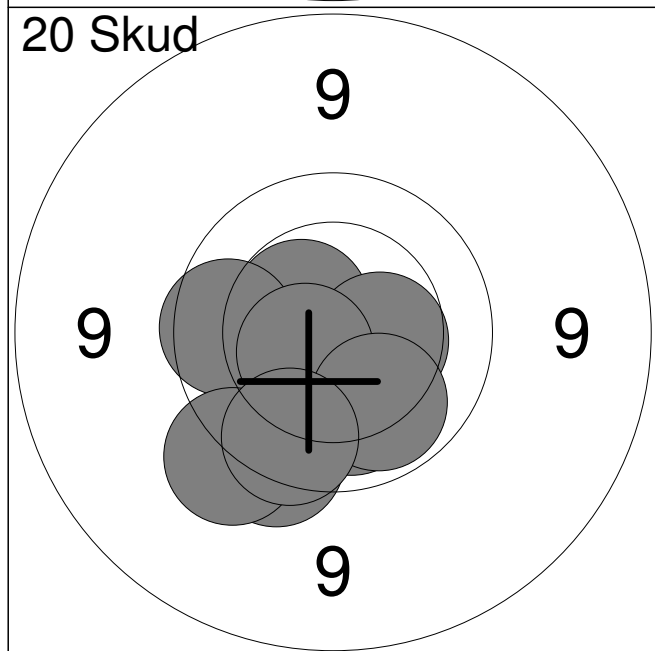

11:	9.8	↘
12:	10.1	↘
13:	10.5x	↑
14:	9.9	←
15:	10.4	→
16:	9.7	↘
17:	9.5	↘
18:	10.6x	←
19:	10.0	↘
20:	9.8	↘
Serie		95 (2x)
Total		193 (4x)

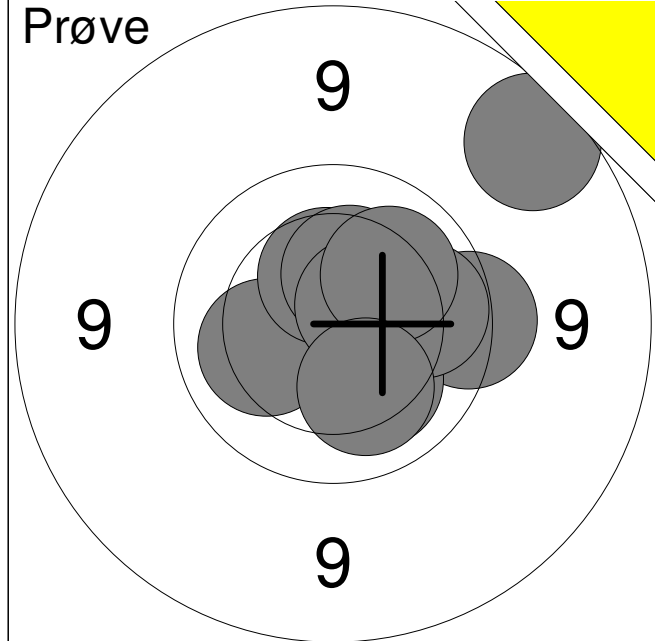

1:	8.9	↗
2:	9.7	→
3:	10.2	←
4:	10.2	↘
5:	10.4	↑
6:	10.4	↑
7:	10.6x	↗
8:	10.0	→
9:	10.1	↗
10:	10.2	↘
Serie		97 (1x)
Total		0 (0x)

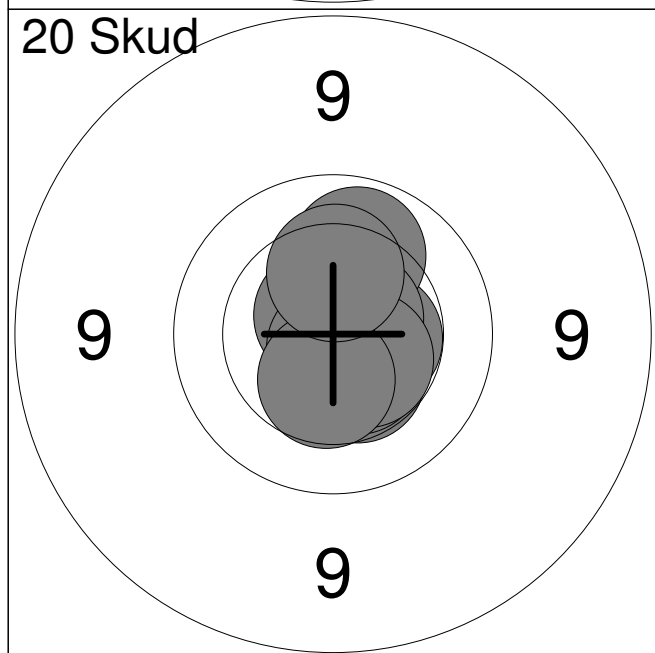

1:	10.5x	→
2:	10.7x	↗
3:	10.0	↑
4:	10.7x	↗
5:	10.8x	↘
6:	10.4	↘
7:	10.5x	↘
8:	10.5x	↘
9:	10.4	↘
10:	10.3	↑
Serie		100 (6x)
Total		100 (6x)

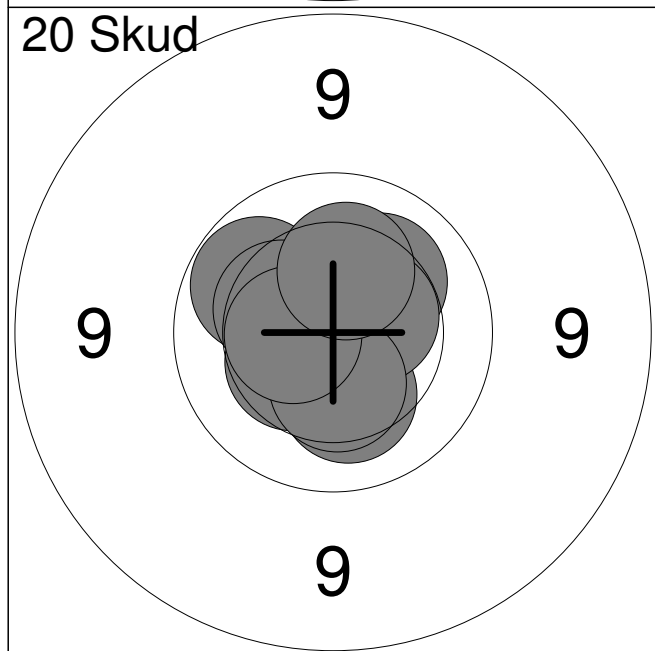

11:	10.0	↖
12:	10.7x	←
13:	10.2	↘
14:	10.3	↖
15:	10.4	↖
16:	10.2	↗
17:	10.5x	↗
18:	10.4	↘
19:	10.5x	←
20:	10.3	↑
Serie		100 (3x)
Total		200 (9x)

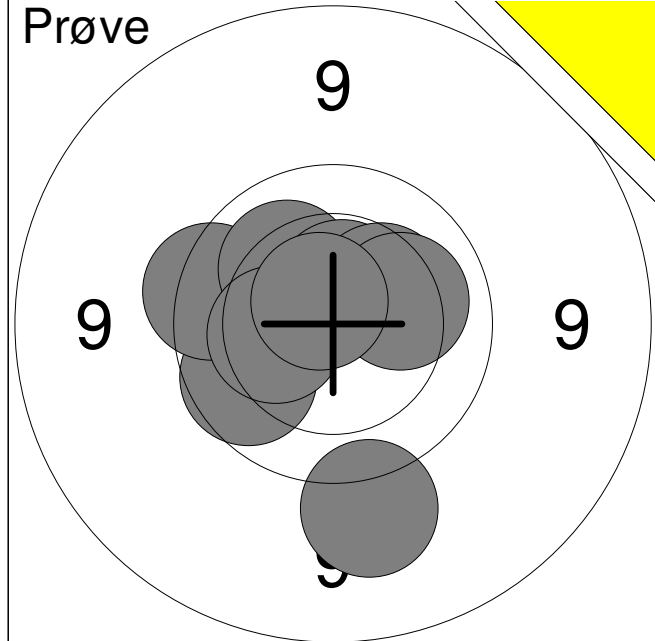

1:	9.3	↓
2:	9.9	↙
3:	9.7	↖
4:	10.2	↗
5:	10.5x	↑
6:	10.3	↖
7:	10.3	↗
8:	10.2	↗
9:	10.7x	↖
Serie		87 (2x)
Total		0 (0x)

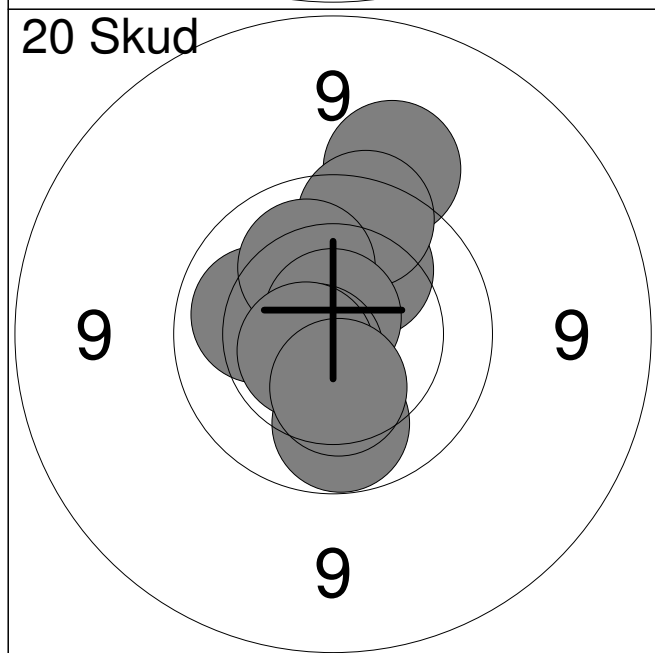

1:	10.1	↖
2:	10.0	↓
3:	10.2	↗
4:	9.4	↗
5:	9.8	↑
6:	10.2	↗
7:	10.8x	↑
8:	10.7x	↙
9:	10.6x	↖
10:	10.4	↓
Serie		98 (3x)
Total		98 (3x)

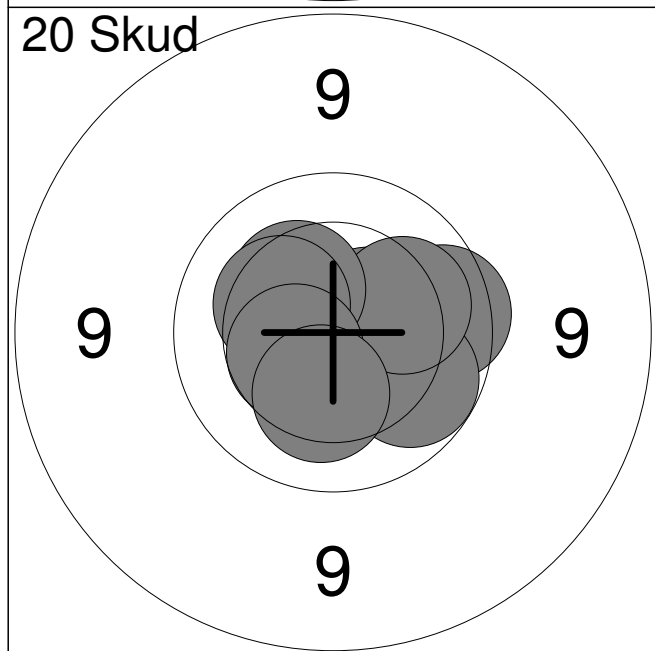

11:	9.8	→
12:	10.5x	↗
13:	10.6x	→
14:	10.0	↘
15:	10.9x	↑
16:	10.1	↗
17:	10.3	↗
18:	10.3	↖
19:	10.5	↖
20:	10.3	↓
Serie		99 (3x)
Total		197 (6x)

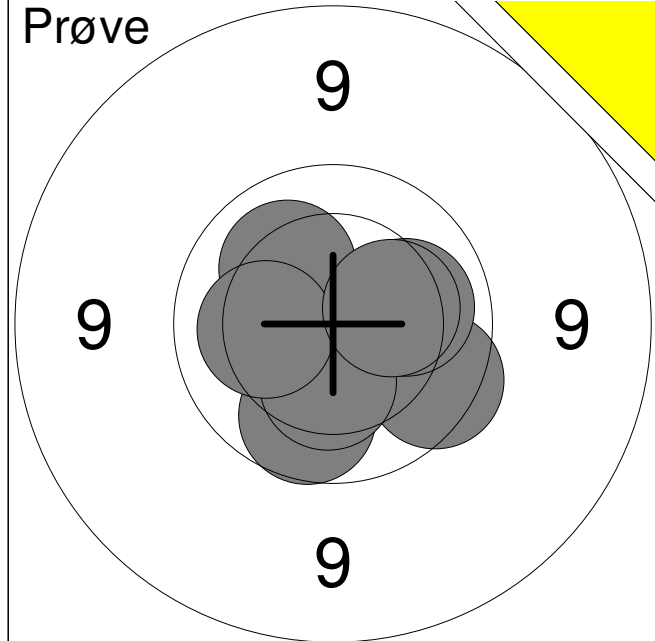

1:	9.8	↘
2:	10.1	→
3:	9.9	↓
4:	10.3	↓
5:	10.2	↗
6:	10.2	←
7:	10.3	→
Serie		68 (0x)
Total		0 (0x)

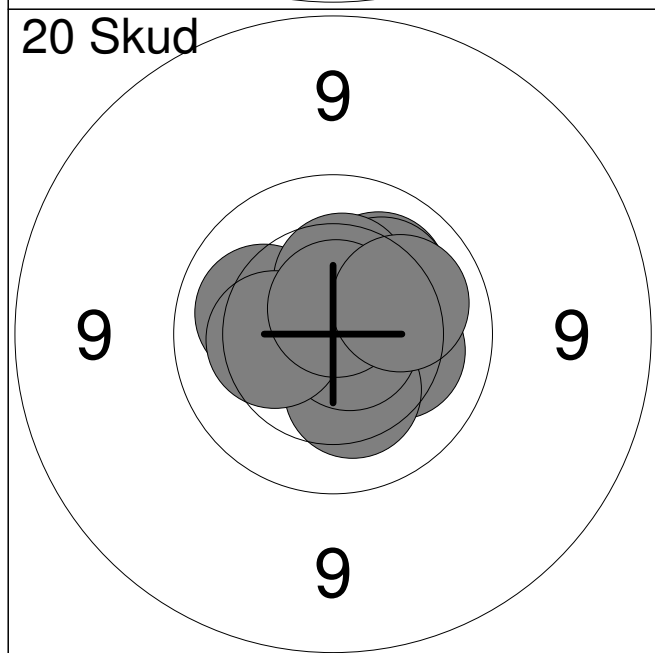

1:	10.1	←
2:	10.2	→
3:	10.3	↓
4:	10.2	↗
5:	10.2	↗
6:	10.7x	→
7:	10.4	↑
8:	10.3	←
9:	10.7x	↑
10:	10.1	↗
Serie		100 (2x)
Total		100 (2x)

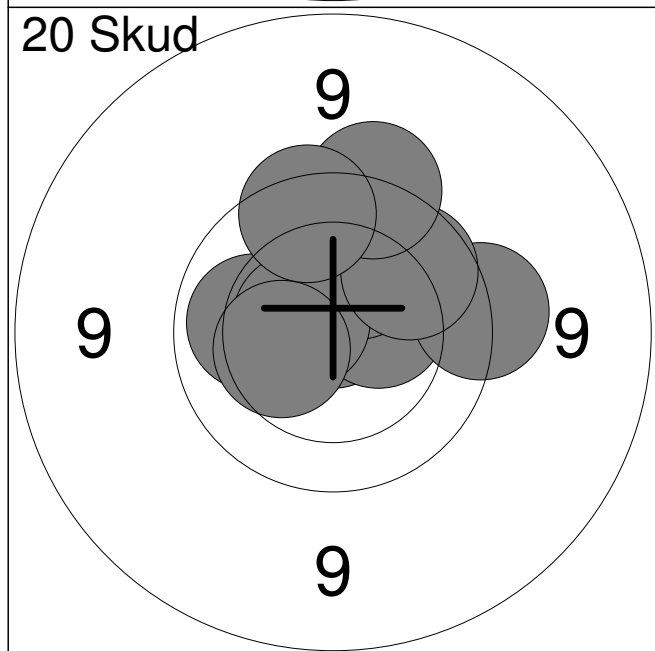

11:	10.8x	↑
12:	10.1	←
13:	10.4	→
14:	10.2	↗
15:	10.6x	←
16:	9.6	→
17:	9.9	↗
18:	10.4	←
19:	9.6	↑
20:	9.8	↑
Serie		96 (2x)
Total		196 (4x)

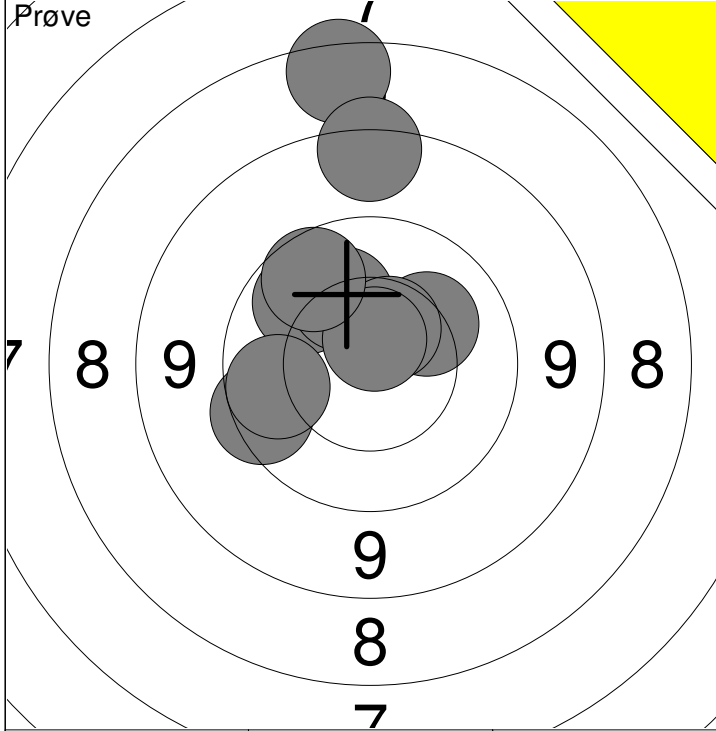

1: 7.7 ↑	6: 9.7 ←
2: 8.6 ↑	7: 10.5 ↗
3: 10.2 ↗	8: 10.0 ←
4: 10.0 ↖	9: 10.7x ↑
5: 10.2 ↗	10: 9.9 ↖

Serie	93 (1x)
Total	0 (0x)

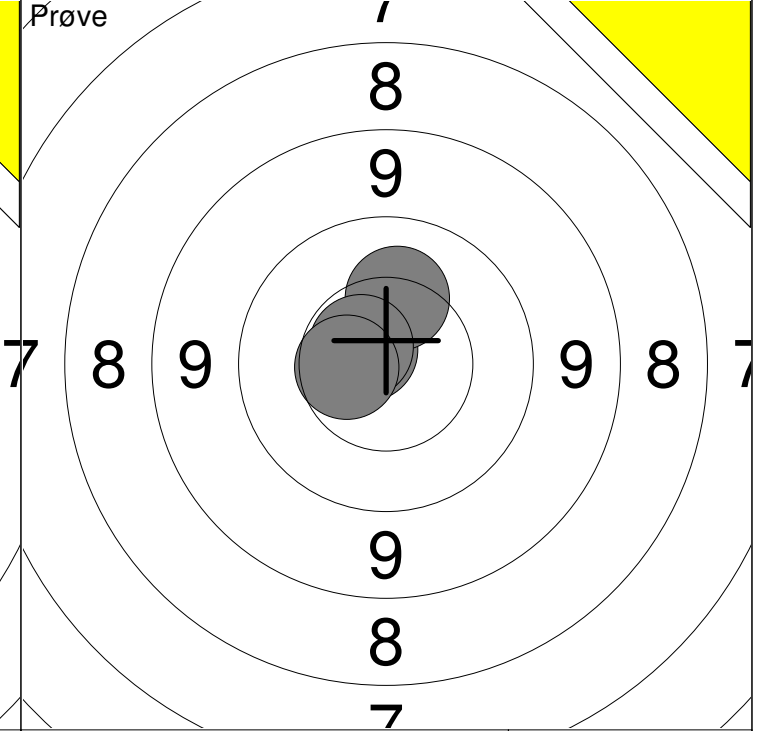

11: 10.7x ↖	12: 10.2 ↑
13: 10.2 ↑	14: 10.6x ↖
15: 10.5 ←	

Serie	40 (2x)
Total	0 (0x)

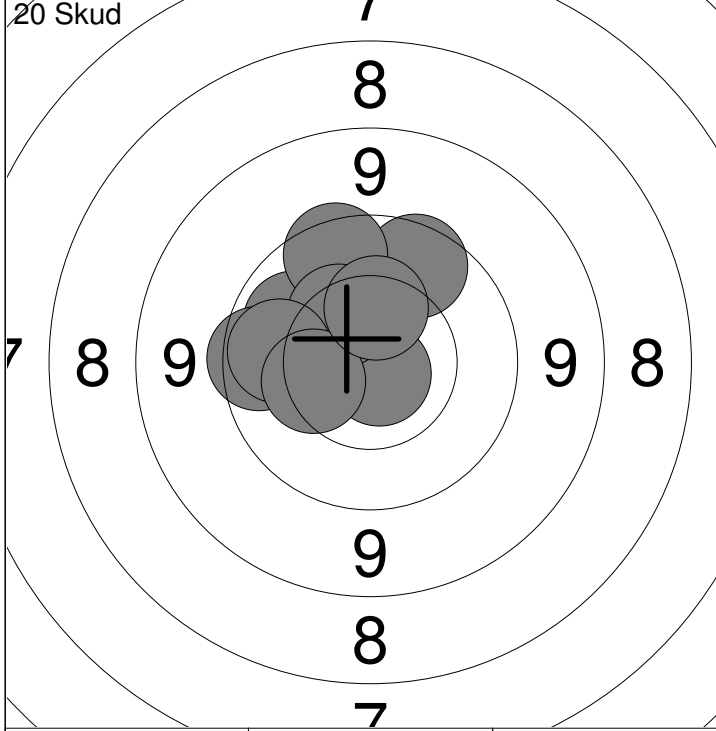

1: 10.7x ←	6: 10.4 ↗
2: 10.8x ↘	7: 9.8 ←
3: 10.1 ↖	8: 10.0 ←
4: 9.8 ↗	9: 10.3 ←
5: 9.7 ↗	10: 10.4 ↑

Serie	97 (2x)
Total	97 (2x)

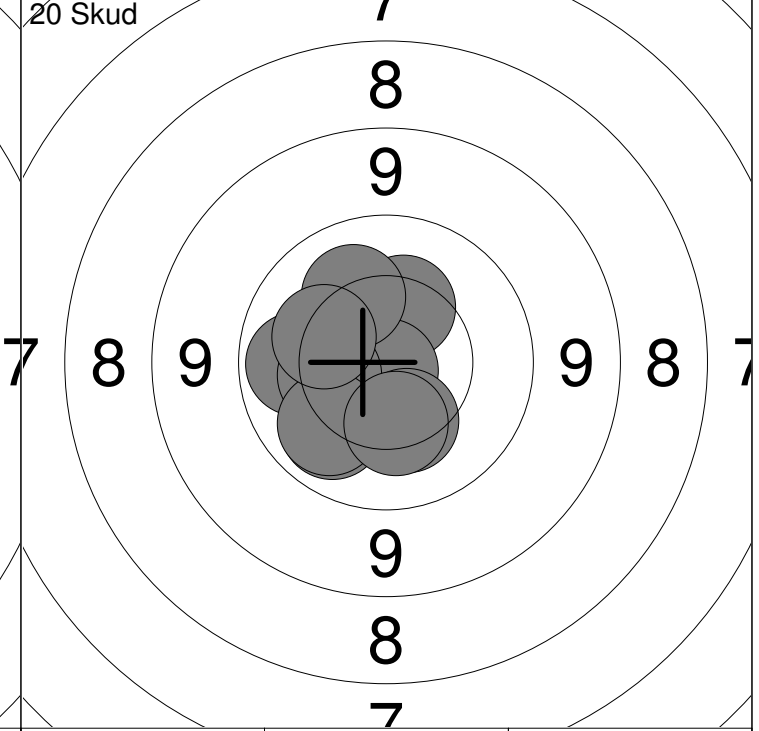

11: 10.3 ↑	12: 10.9x ↓	16: 10.3 ↓
13: 10.0 ←	14: 10.3 ←	17: 10.1 ↘
15: 10.1 ↘	18: 10.2 ↗	19: 10.2 ↖
	20: 10.3 ↓	

Serie	100 (1x)
Total	197 (3x)

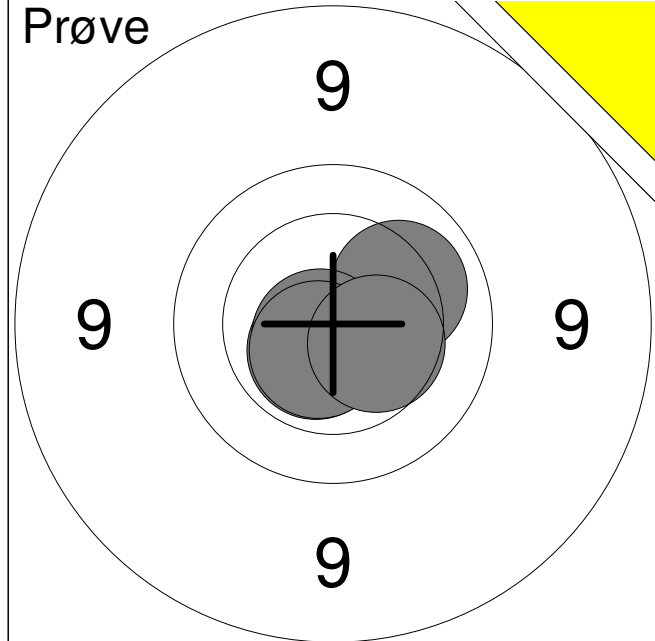

1:	10.1	➔
2:	10.6x	⬇
3:	10.7x	⬇
4:	10.6x	⬇
5:	10.4	➔
Serie		50 (3x)
Total		0 (0x)

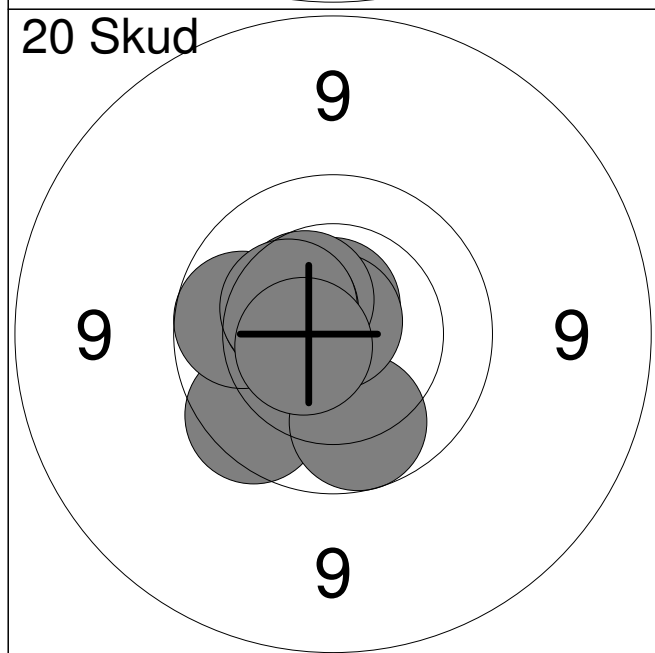

1:	9.8	⬇
2:	9.9	⬇
3:	10.6x	⬆
4:	9.9	⬅
5:	10.7x	↗
6:	10.8x	⬆
7:	10.5	↗
8:	10.4	⬅
9:	10.4	⬅
10:	10.6x	⬅
Serie		97 (4x)
Total		97 (4x)

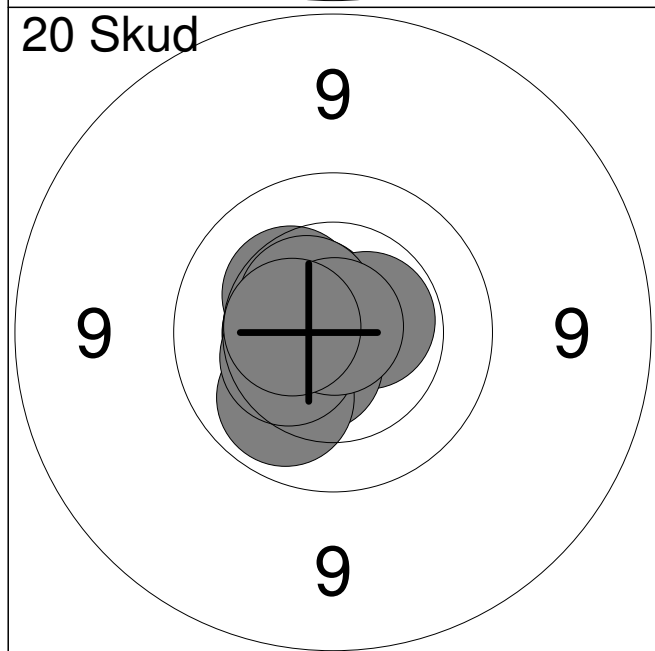

11:	10.5	⬅
12:	10.6x	↗
13:	10.6x	➔
14:	10.3	↗
15:	10.5x	⬇
16:	10.1	⬇
17:	10.5x	↗
18:	10.4	⬅
19:	10.9x	⬆
20:	10.5x	⬅
Serie		100 (6x)
Total		197 (10x)

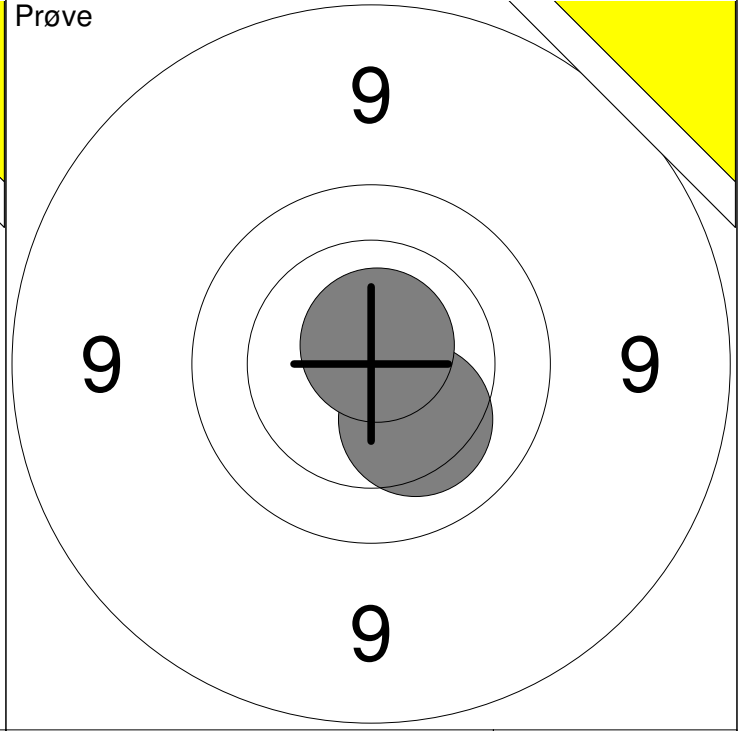
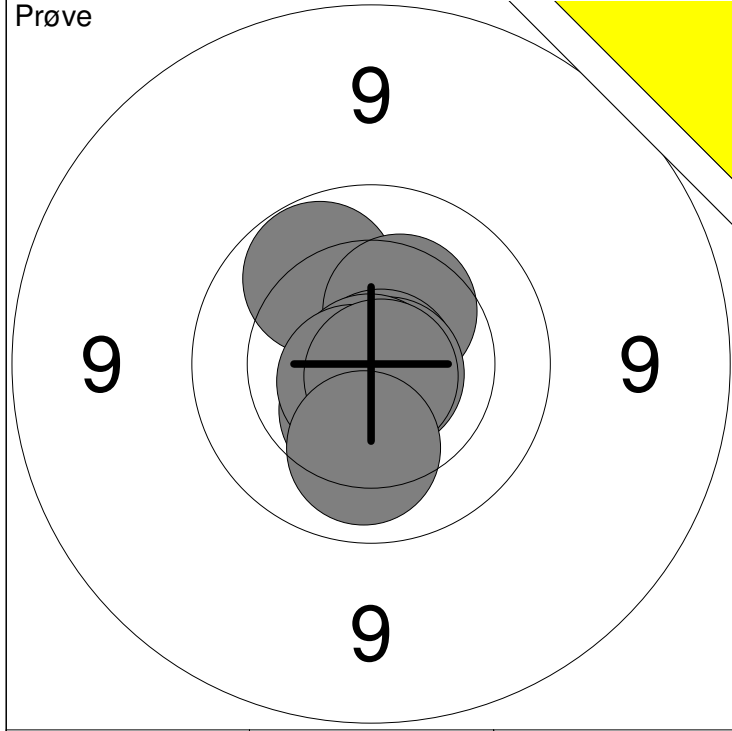

2: 10.0 ↗	7: 10.9x ↓	Serie	90 (5x)
3: 10.4 ↗	8: 10.7x ↘		
4: 10.8x →	9: 10.8x ↘	Total	0 (0x)
5: 10.5 ↓	10: 10.1 ↓		
6: 10.8x ↘			

11: 10.3 ↘	Serie	20 (1x)
12: 10.8x ↗		
	Total	0 (0x)

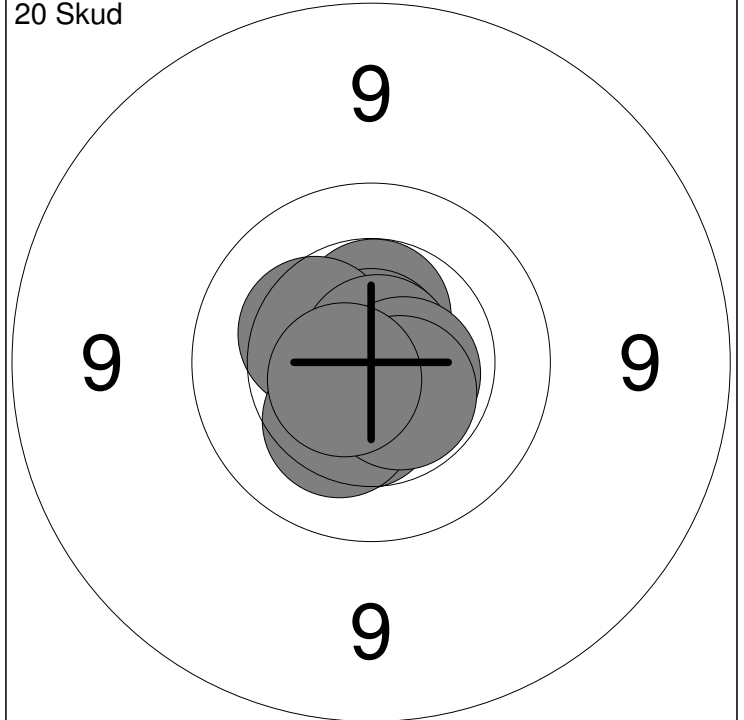
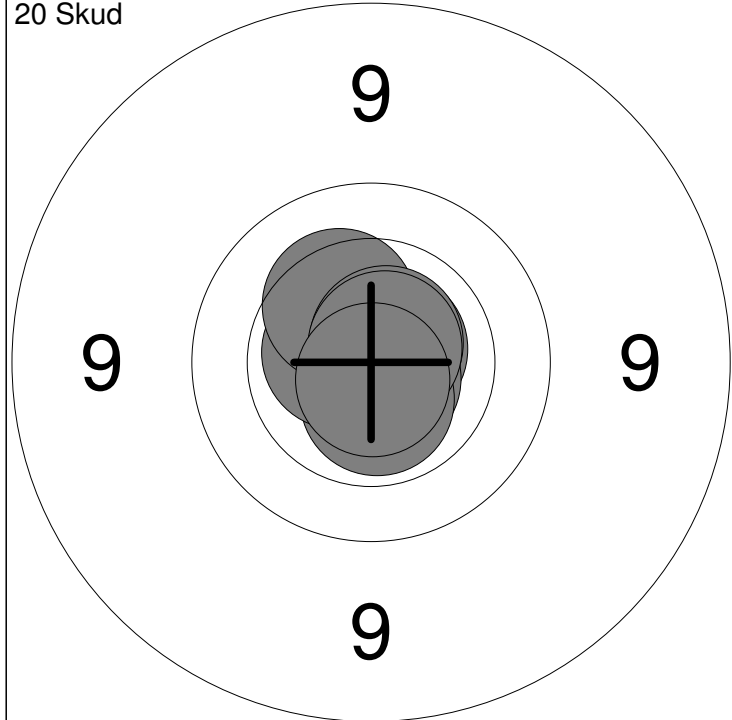

1: 10.7x ↗	6: 10.6x ←	Serie	100 (8x)
2: 10.7x ↘	7: 10.3 ↗		
3: 10.6x ↓	8: 10.7x ↗	Total	100 (8x)
4: 10.4 ↗	9: 10.8x ↗		
5: 10.8x ↗	10: 10.8x ↓		

11: 10.8x ←	16: 10.8x ↗	Serie	100 (7x)
12: 10.5x ↗	17: 10.3 ↓		
13: 10.8x ↗	18: 10.6x →	Total	200 (15x)
14: 10.5 ↓	19: 10.5x ↘		
15: 10.3 ←	20: 10.6x ↘		

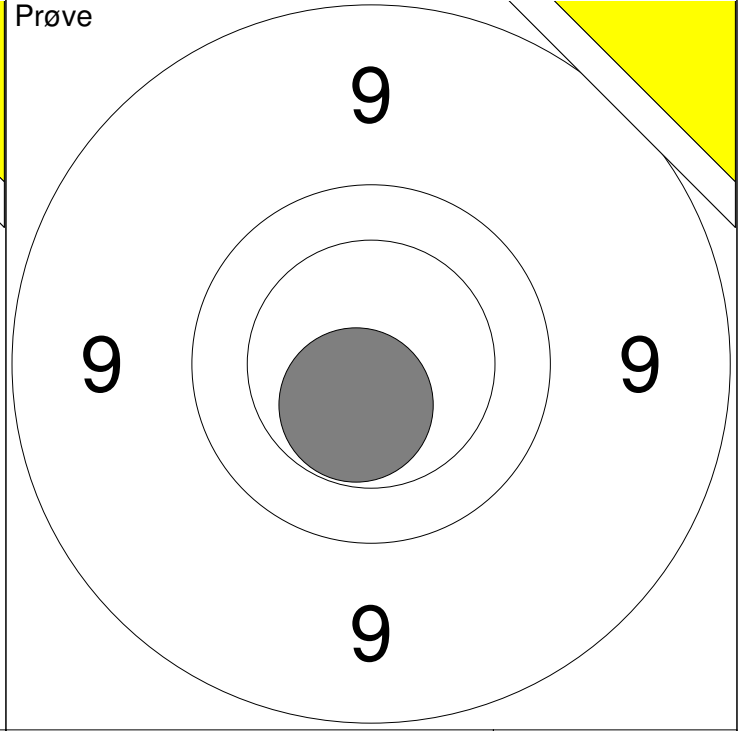
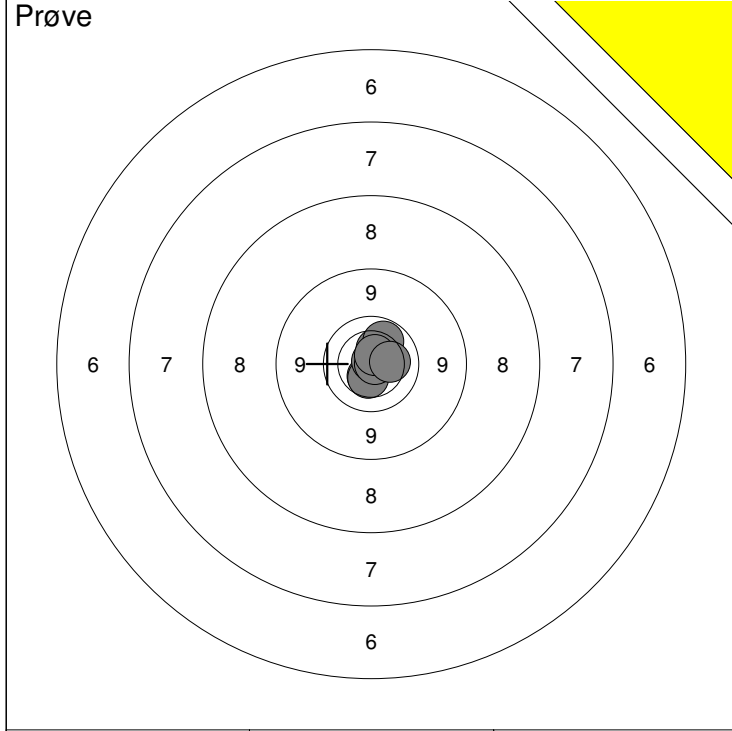

1: 0.0 ←	6: 10.8x ↗	Serie	80 (3x)
2: 10.5 ↓	7: 10.8x →		
3: 10.4 ↓	8: 10.6x ↗	Total	0 (0x)
4: 10.4 ↗	10: 10.2 →		
5: 10.0 ↗			

11: 10.5x ↓	Serie	10 (1x)
	Total	0 (0x)

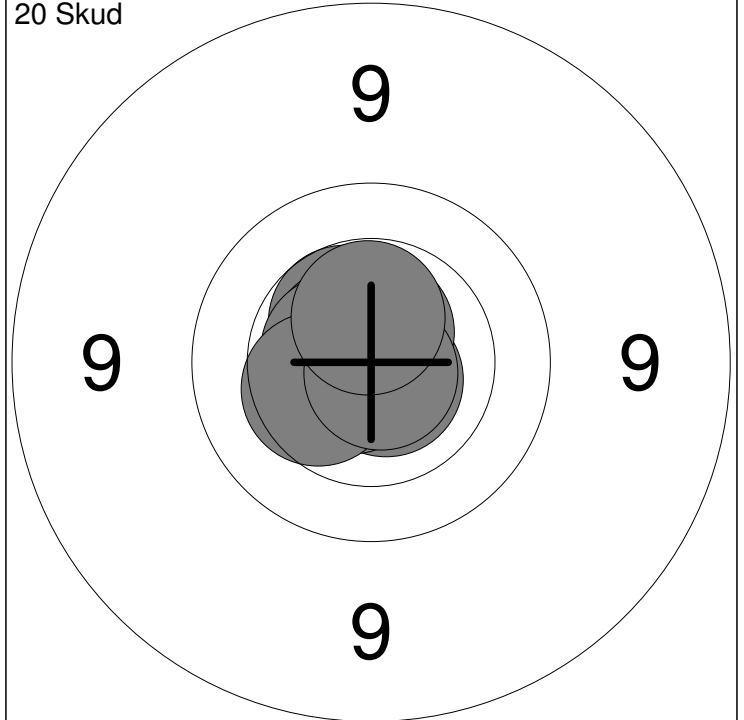
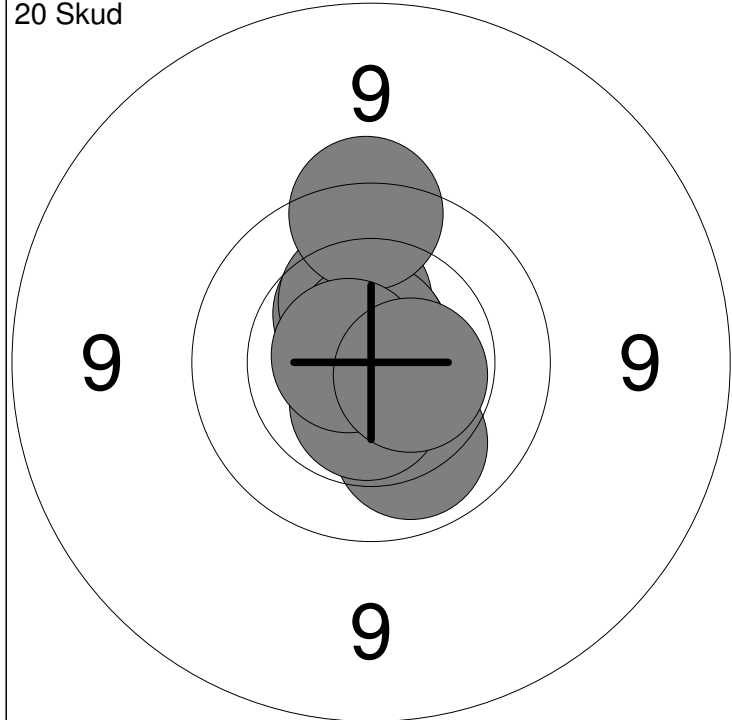

1: 10.8x ↓	6: 10.7x ↗	Serie	99 (6x)
2: 10.4 ↗	7: 10.6x ↓		
3: 10.1 ↓	8: 9.7 ↗	Total	99 (6x)
4: 10.3 ↗	9: 10.7x ←		
5: 10.7x ↗	10: 10.5x →		

11: 10.5 ↗	16: 10.6x ↗	Serie	100 (8x)
12: 10.9x ↗	17: 10.6x ←		
13: 10.7x ↓	18: 10.4 ←	Total	199 (14x)
14: 10.7x ←	19: 10.8x ↓		
15: 10.6x ↗	20: 10.5x ↗		

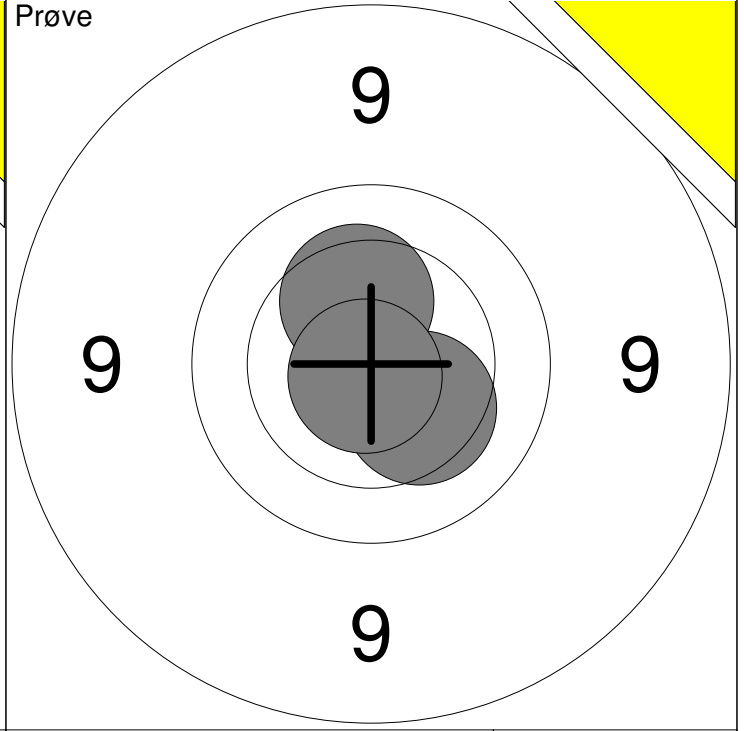
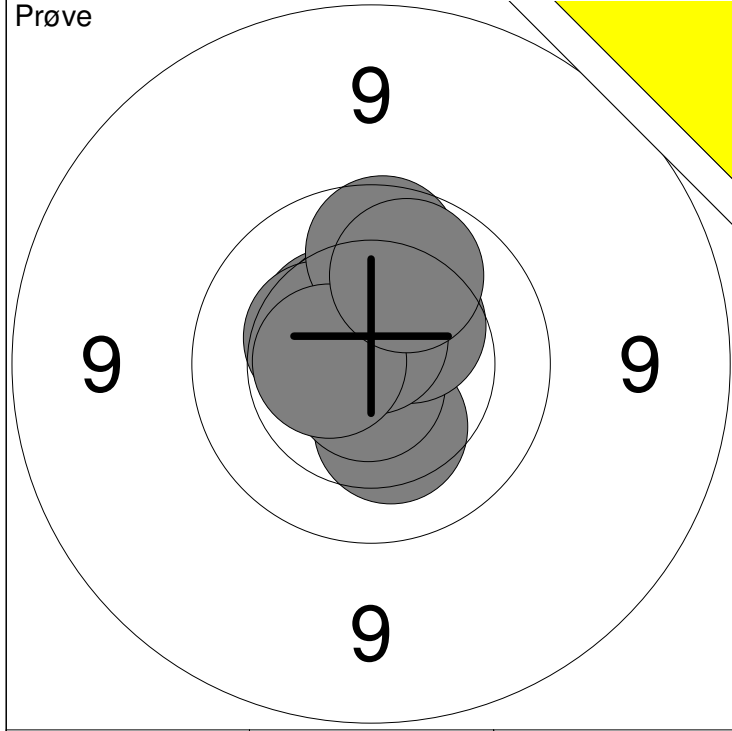

1: 10.3 ↓	6: 10.4 ↖	Serie 99 (3x)
2: 10.7x ↓	7: 10.7x ↑	
3: 10.4 ↖	8: 9.9 ↑	Total 0 (0x)
4: 10.4 ↗	9: 10.5x ←	
5: 10.5 ↑	10: 10.0 ↗	

11: 10.3 ↑	Serie 30 (1x)
12: 10.3 ↓	
13: 10.8x ↓	Total 0 (0x)

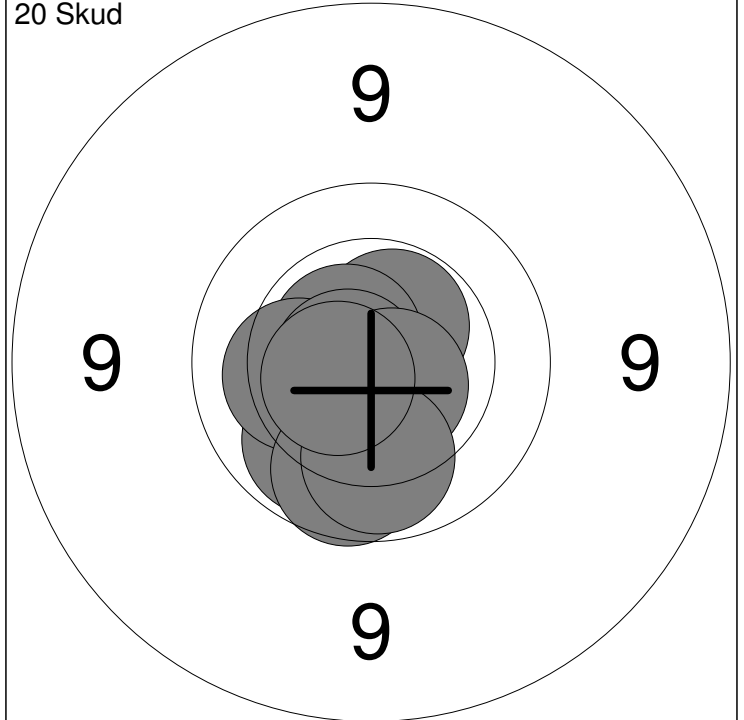
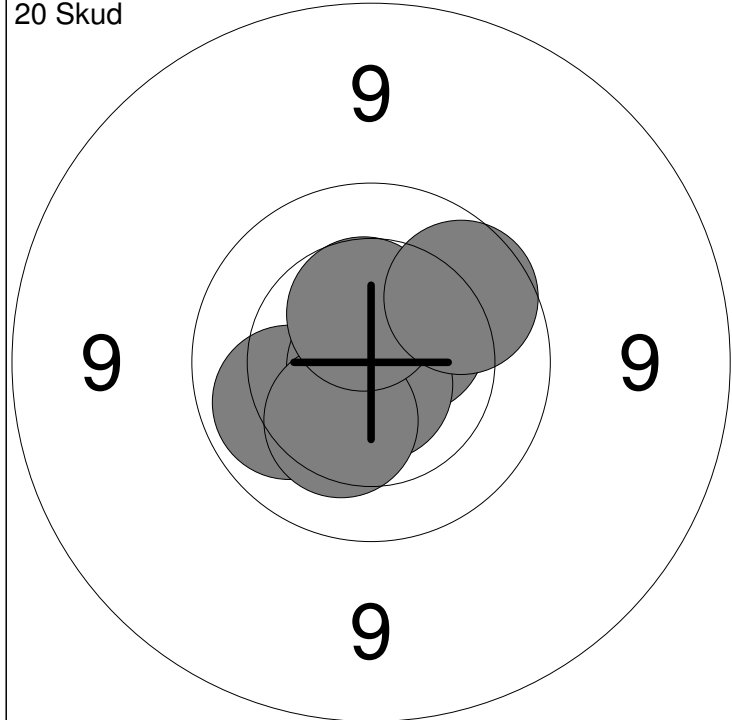

1: 10.9x ↓	6: 10.9x ↖	Serie 99 (5x)
2: 10.4 ↗	7: 10.7x ↓	
3: 10.5x ↗	8: 10.3 ↓	Total 99 (5x)
4: 10.1 ↖	9: 10.5 ↑	
5: 10.6x ↓	10: 9.9 ↗	

11: 10.8x ↓	16: 10.7x ↖	Serie 99 (6x)
12: 10.5x ↗	17: 10.6x ↓	
13: 10.0 ↖	18: 9.9 ↓	Total 198 (11x)
14: 10.6x ↖	19: 10.0 ↓	
15: 10.2 ↖	20: 10.6x ↖	

	Nordjysk mesterskab 2019	Aalborg Skyttekreds																																													
Prøve 	<table style="width:100%; border-collapse: collapse;"> <tr><td style="width:5%;">1:</td><td style="width:15%;">9.8</td><td style="width:10%;"></td><td style="width:10%; text-align: center;">↘</td></tr> <tr><td>2:</td><td>10.3</td><td></td><td style="text-align: center;">↓</td></tr> <tr><td>3:</td><td>10.4</td><td></td><td style="text-align: center;">→</td></tr> <tr><td>4:</td><td>10.6x</td><td></td><td style="text-align: center;">↘</td></tr> <tr><td>5:</td><td>10.7x</td><td></td><td style="text-align: center;">↗</td></tr> <tr><td>6:</td><td>10.6x</td><td></td><td style="text-align: center;">↓</td></tr> <tr><td>7:</td><td>10.7x</td><td></td><td style="text-align: center;">↘</td></tr> <tr><td>8:</td><td>10.7x</td><td></td><td style="text-align: center;">↓</td></tr> <tr><td colspan="4"><hr/></td></tr> <tr><td colspan="3">Serie</td><td style="text-align: right;">79 (5x)</td></tr> <tr><td colspan="3">Total</td><td style="text-align: right;">0 (0x)</td></tr> </table>			1:	9.8		↘	2:	10.3		↓	3:	10.4		→	4:	10.6x		↘	5:	10.7x		↗	6:	10.6x		↓	7:	10.7x		↘	8:	10.7x		↓	<hr/>				Serie			79 (5x)	Total			0 (0x)
1:	9.8		↘																																												
2:	10.3		↓																																												
3:	10.4		→																																												
4:	10.6x		↘																																												
5:	10.7x		↗																																												
6:	10.6x		↓																																												
7:	10.7x		↘																																												
8:	10.7x		↓																																												
<hr/>																																															
Serie			79 (5x)																																												
Total			0 (0x)																																												

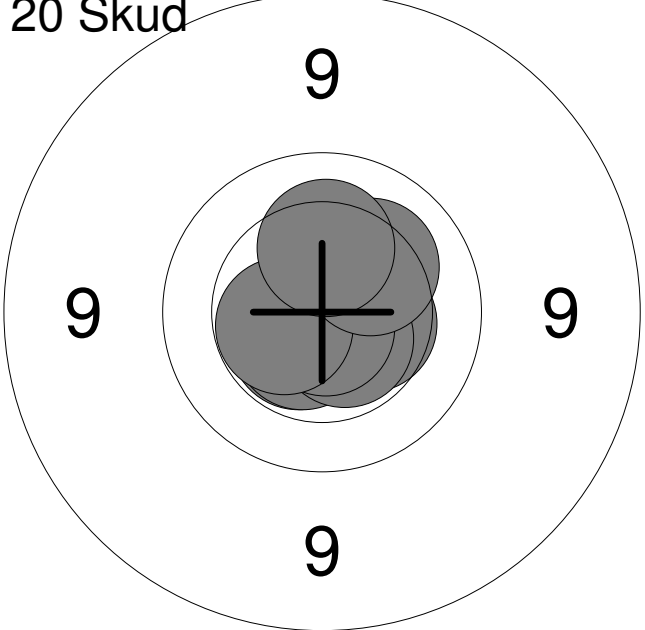
20 Skud 	<table style="width:100%; border-collapse: collapse;"> <tr><td style="width:5%;">1:</td><td style="width:15%;">10.5x</td><td style="width:10%;"></td><td style="width:10%; text-align: center;">→</td></tr> <tr><td>2:</td><td>10.6x</td><td></td><td style="text-align: center;">↓</td></tr> <tr><td>3:</td><td>10.4</td><td></td><td style="text-align: center;">→</td></tr> <tr><td>4:</td><td>10.5x</td><td></td><td style="text-align: center;">↘</td></tr> <tr><td>5:</td><td>10.6x</td><td></td><td style="text-align: center;">↘</td></tr> <tr><td>6:</td><td>10.6x</td><td></td><td style="text-align: center;">↘</td></tr> <tr><td>7:</td><td>10.8x</td><td></td><td style="text-align: center;">↓</td></tr> <tr><td>8:</td><td>10.5x</td><td></td><td style="text-align: center;">←</td></tr> <tr><td>9:</td><td>10.2</td><td></td><td style="text-align: center;">↗</td></tr> <tr><td>10:</td><td>10.2</td><td></td><td style="text-align: center;">↑</td></tr> <tr><td colspan="4"><hr/></td></tr> <tr><td colspan="3">Serie</td><td style="text-align: right;">100 (7x)</td></tr> <tr><td colspan="3">Total</td><td style="text-align: right;">100 (7x)</td></tr> </table>			1:	10.5x		→	2:	10.6x		↓	3:	10.4		→	4:	10.5x		↘	5:	10.6x		↘	6:	10.6x		↘	7:	10.8x		↓	8:	10.5x		←	9:	10.2		↗	10:	10.2		↑	<hr/>				Serie			100 (7x)	Total			100 (7x)
1:	10.5x		→																																																				
2:	10.6x		↓																																																				
3:	10.4		→																																																				
4:	10.5x		↘																																																				
5:	10.6x		↘																																																				
6:	10.6x		↘																																																				
7:	10.8x		↓																																																				
8:	10.5x		←																																																				
9:	10.2		↗																																																				
10:	10.2		↑																																																				
<hr/>																																																							
Serie			100 (7x)																																																				
Total			100 (7x)																																																				

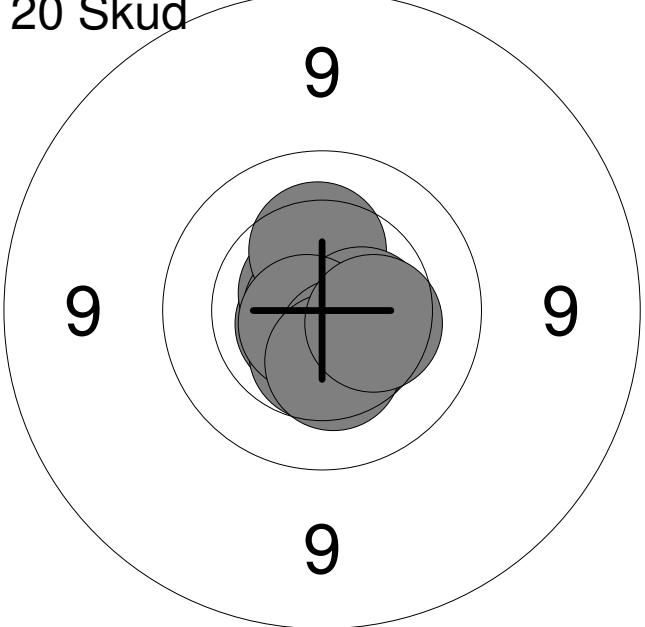
20 Skud 	<table style="width:100%; border-collapse: collapse;"> <tr><td style="width:5%;">11:</td><td style="width:15%;">10.7x</td><td style="width:10%;"></td><td style="width:10%; text-align: center;">↙</td></tr> <tr><td>12:</td><td>10.7x</td><td></td><td style="text-align: center;">↗</td></tr> <tr><td>13:</td><td>10.8x</td><td></td><td style="text-align: center;">←</td></tr> <tr><td>14:</td><td>10.5</td><td></td><td style="text-align: center;">↓</td></tr> <tr><td>15:</td><td>10.3</td><td></td><td style="text-align: center;">↑</td></tr> <tr><td>16:</td><td>10.5x</td><td></td><td style="text-align: center;">→</td></tr> <tr><td>17:</td><td>10.7x</td><td></td><td style="text-align: center;">↙</td></tr> <tr><td>18:</td><td>10.5</td><td></td><td style="text-align: center;">↘</td></tr> <tr><td>19:</td><td>10.4</td><td></td><td style="text-align: center;">↘</td></tr> <tr><td>20:</td><td>10.4</td><td></td><td style="text-align: center;">→</td></tr> <tr><td colspan="4"><hr/></td></tr> <tr><td colspan="3">Serie</td><td style="text-align: right;">100 (5x)</td></tr> <tr><td colspan="3">Total</td><td style="text-align: right;">200 (12x)</td></tr> </table>			11:	10.7x		↙	12:	10.7x		↗	13:	10.8x		←	14:	10.5		↓	15:	10.3		↑	16:	10.5x		→	17:	10.7x		↙	18:	10.5		↘	19:	10.4		↘	20:	10.4		→	<hr/>				Serie			100 (5x)	Total			200 (12x)
11:	10.7x		↙																																																				
12:	10.7x		↗																																																				
13:	10.8x		←																																																				
14:	10.5		↓																																																				
15:	10.3		↑																																																				
16:	10.5x		→																																																				
17:	10.7x		↙																																																				
18:	10.5		↘																																																				
19:	10.4		↘																																																				
20:	10.4		→																																																				
<hr/>																																																							
Serie			100 (5x)																																																				
Total			200 (12x)																																																				

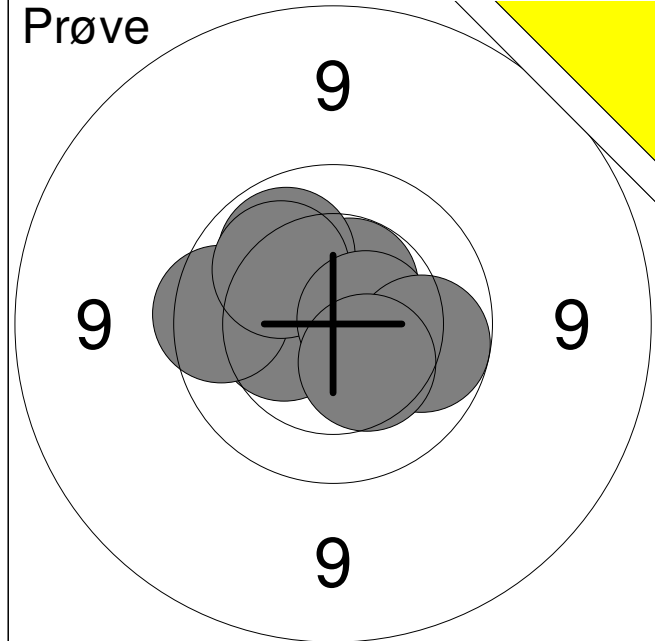

1:	10.9x	↗
2:	10.4	←
3:	9.8	←
4:	10.4	↘
5:	10.5x	↗
6:	10.0	↗
7:	10.1	↗
8:	10.6x	→
9:	10.0	→
10:	10.4	↘
Serie		99 (3x)
Total		0 (0x)

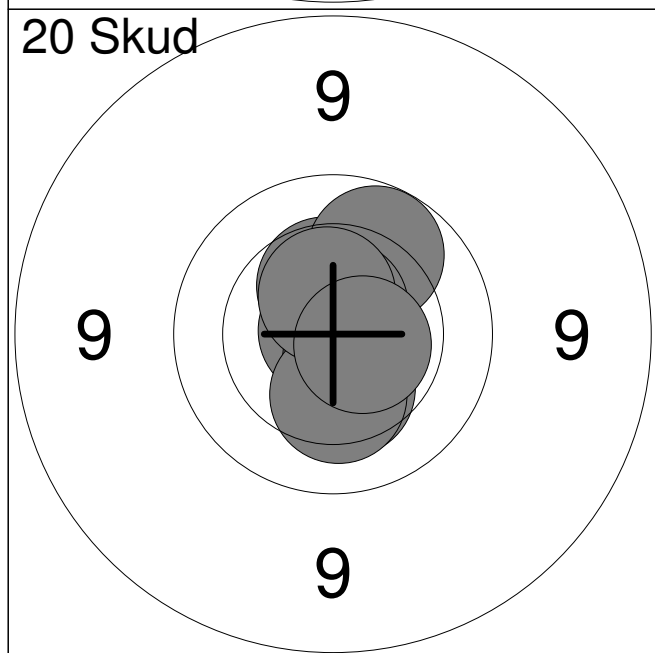

1:	10.7x	→
2:	10.4	↑
3:	10.9x	↗
4:	10.6x	↘
5:	10.0	↗
6:	10.7x	↑
7:	10.3	↘
8:	10.3	↘
9:	10.5x	↑
10:	10.6x	→
Serie		100 (6x)
Total		100 (6x)

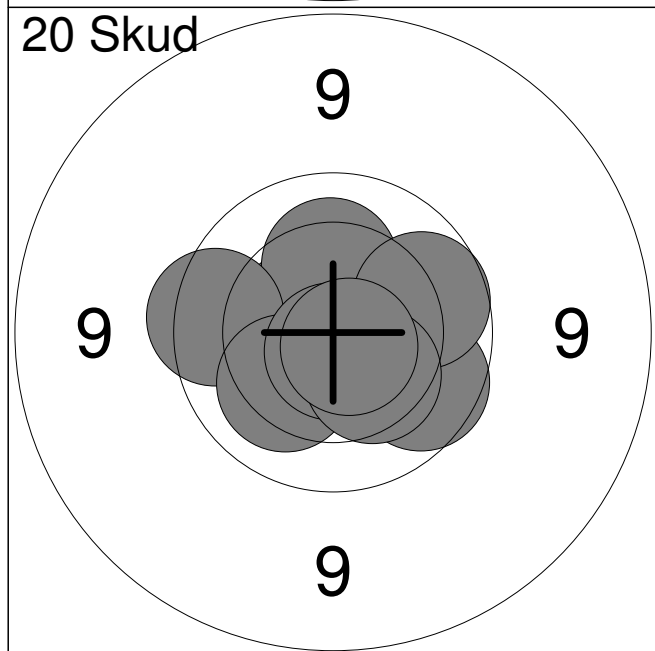

11:	10.6x	↖
12:	10.8x	→
13:	10.2	↑
14:	9.9	↘
15:	9.8	←
16:	10.2	↘
17:	9.9	→
18:	10.7x	↘
19:	10.3	↘
20:	10.7x	↘
Serie		97 (4x)
Total		197 (10x)

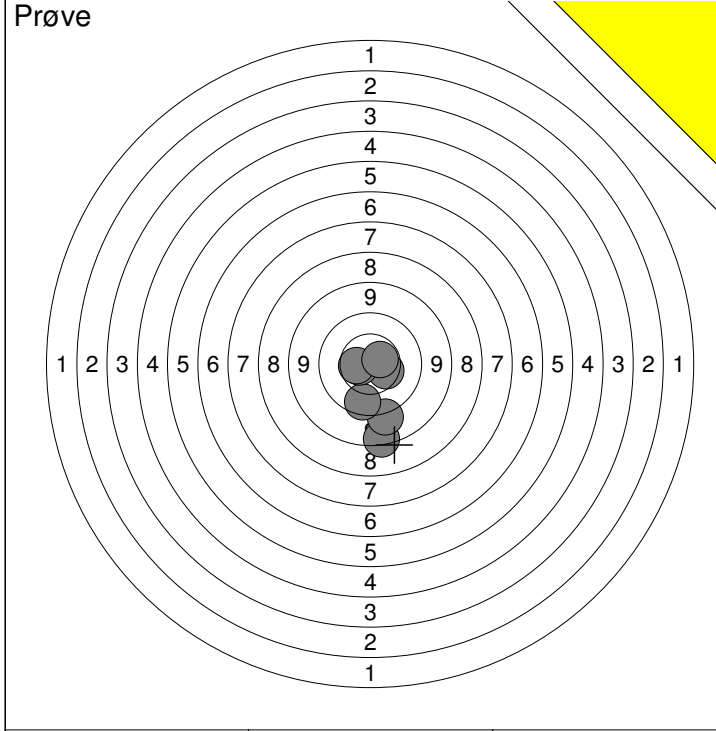

1: 8.5 ↓	7: 10.5 ←	Serie	66 (2x)
2: 9.2 ↓	8: 10.6x →		
3: 10.4 →	10: 0.0 ↓	Total	0 (0x)
4: 9.8 ↓			
6: 10.6x ←			

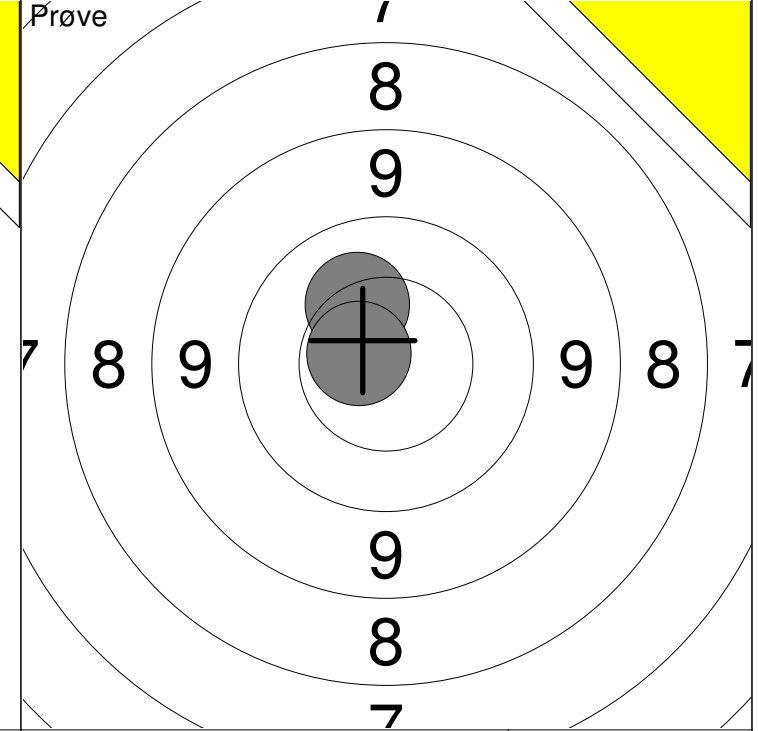

11: 10.3 ↗	Serie	20 (1x)
12: 10.6x ←		
	Total	0 (0x)

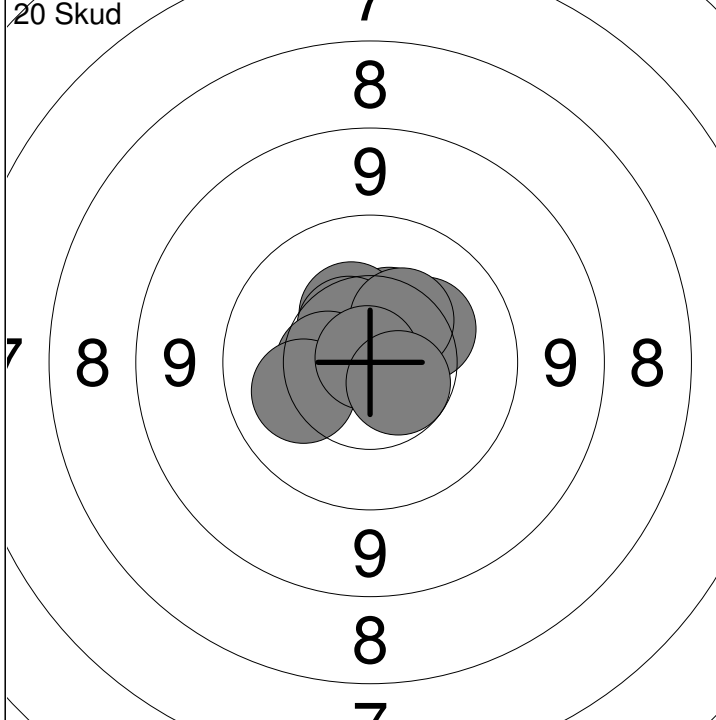

1: 10.7x →	6: 10.2 ←	Serie	100 (2x)
2: 10.5 ↗	7: 10.3 →		
3: 10.4 ↗	8: 10.4 ↗	Total	100 (2x)
4: 10.5 ↗	9: 10.9x ↗		
5: 10.5 ←	10: 10.6 ↘		

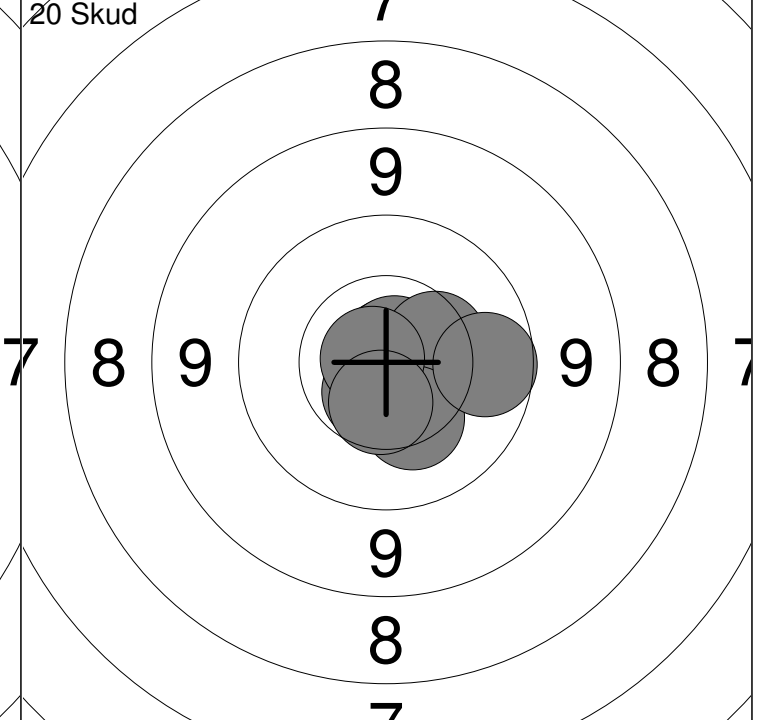

11: 10.8x ↗	16: 10.3 ↓	Serie	99 (6x)
12: 10.8x ↓	17: 10.6x ↓		
13: 10.9x →	18: 10.8x ←	Total	199 (8x)
14: 10.8x ↗	19: 9.9 →		
15: 10.4 →	20: 10.5 ↓		

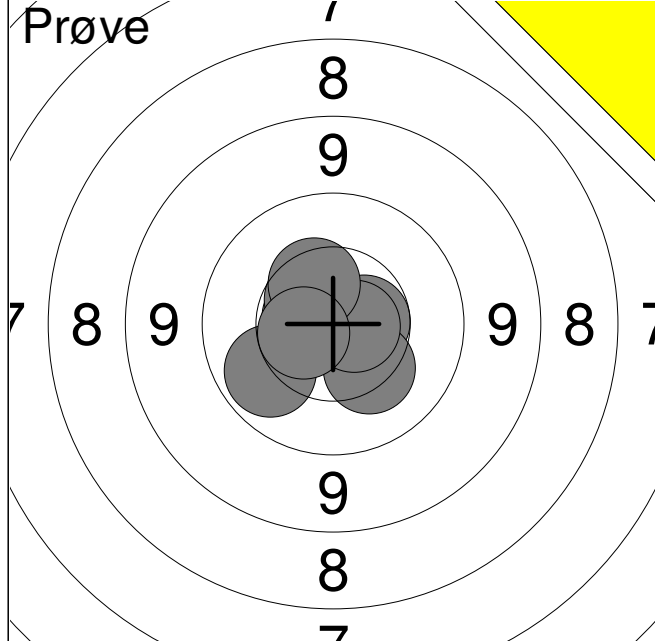

1:	10.0	↙
2:	10.6	→
3:	10.3	↘
4:	10.6x	↖
5:	10.6	↗
6:	10.7x	→
7:	10.4	↗
9:	10.6x	←
Serie		80 (3x)
Total		0 (0x)

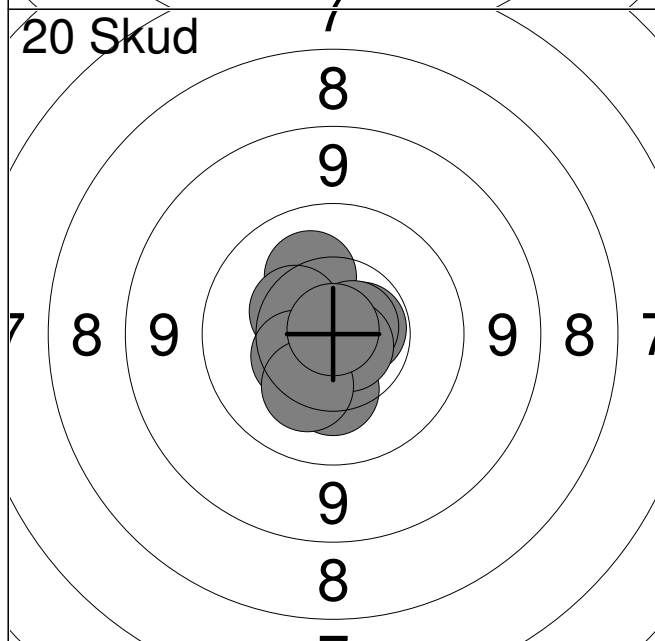

1:	10.9x	→
2:	10.2	↗
3:	10.6x	→
4:	10.7x	→
5:	10.3	↘
6:	10.7x	↘
7:	10.4	↗
8:	10.4	←
9:	10.3	↘
10:	10.9x	↑
Serie		100 (5x)
Total		100 (5x)

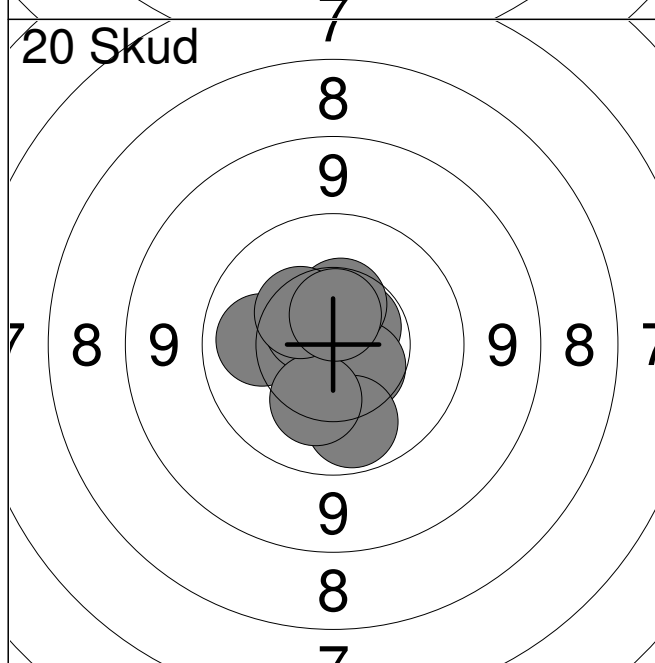

11:	10.8x	↗
12:	10.6x	↗
13:	10.5	↘
14:	10.0	↘
15:	10.1	←
16:	10.6x	↗
17:	10.5	↑
18:	10.3	↘
19:	10.4	↗
20:	10.6x	↑
Serie		100 (4x)
Total		200 (9x)

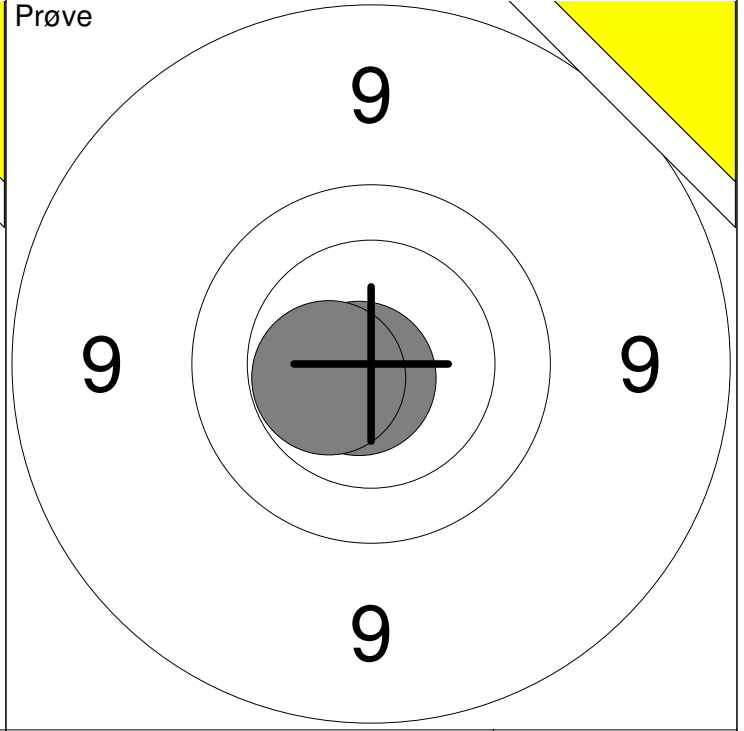
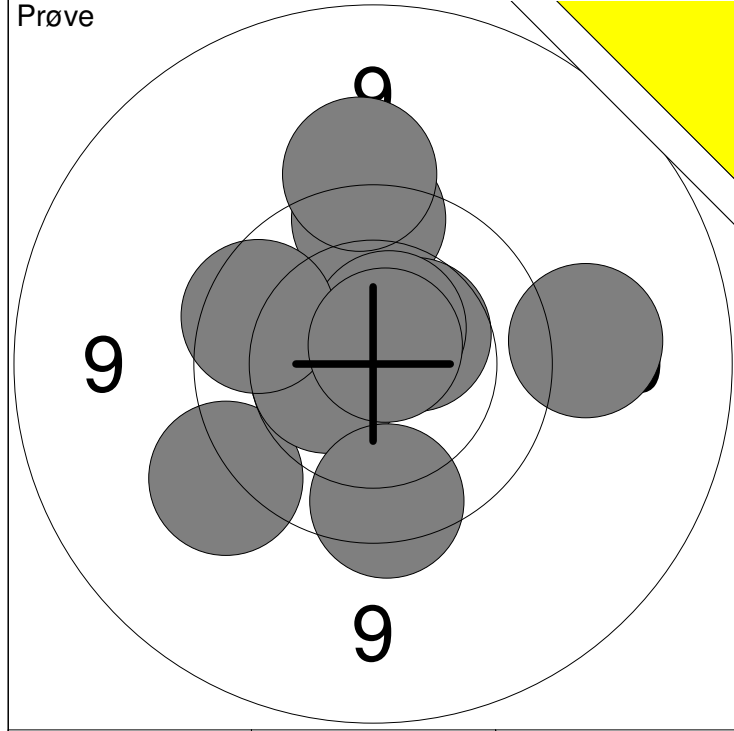

1: 9.3 →	6: 9.5 ↙	Serie	94 (2x)
2: 9.7 ↑	7: 10.5 ←		
3: 9.5 ↑	8: 9.8 ↙	Total	0 (0x)
4: 10.5 ↗	9: 10.7x ↗		
5: 10.6x ↗	10: 9.8 ↓		

11: 10.8x ↙	Serie	20 (2x)
12: 10.5x ←		
Total		0 (0x)

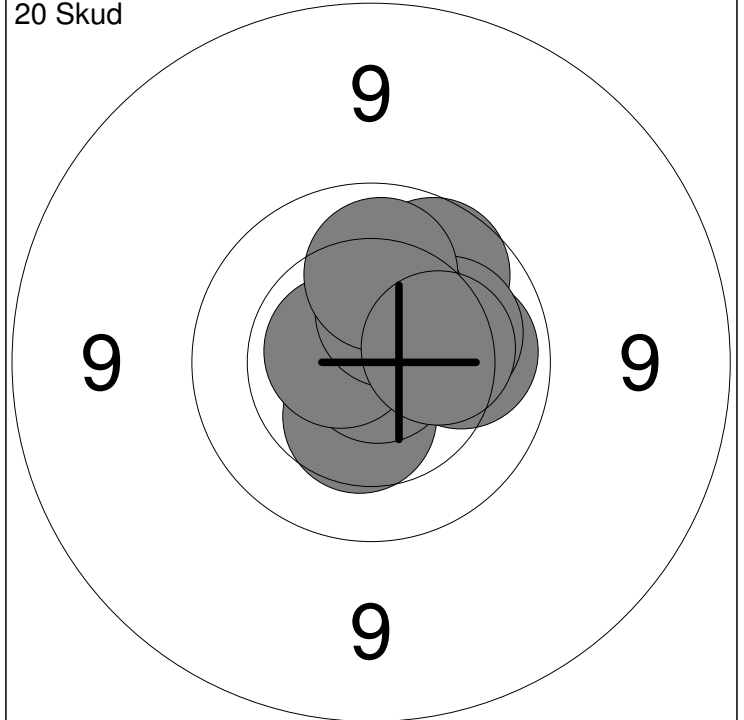
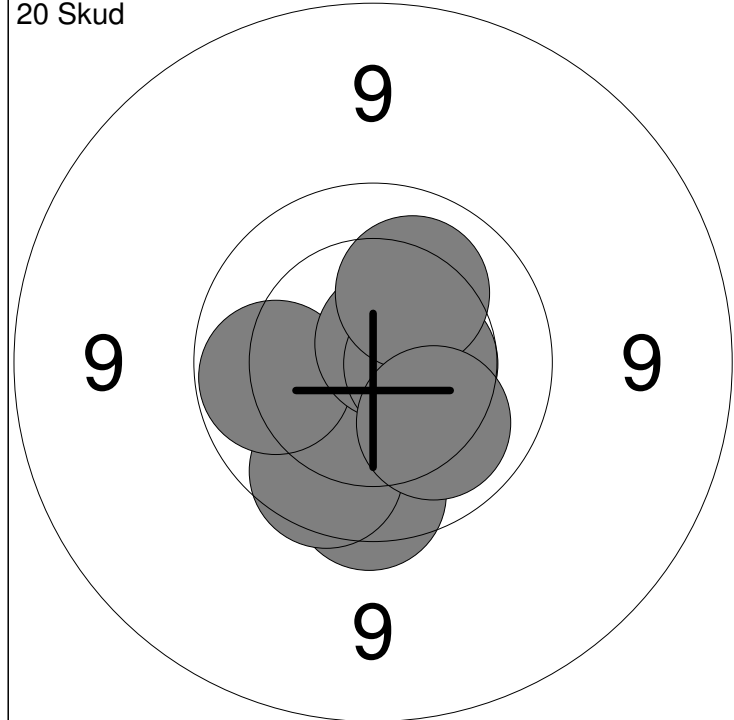

1: 10.9x ↓	6: 10.0 ←	Serie	98 (3x)
2: 9.8 ↓	7: 10.7x ↗		
3: 10.3 ↙	8: 10.5 →	Total	98 (3x)
4: 10.9x ↘	9: 10.2 ↗		
5: 9.9 ↙	10: 10.1 ↘		

11: 10.4 ↓	16: 10.6x ←	Serie	99 (3x)
12: 10.6x ↗	17: 10.2 ↗		
13: 9.9 ↗	18: 10.4 ↗	Total	197 (6x)
14: 10.1 →	19: 10.1 ↑		
15: 10.9x ↘	20: 10.3 →		

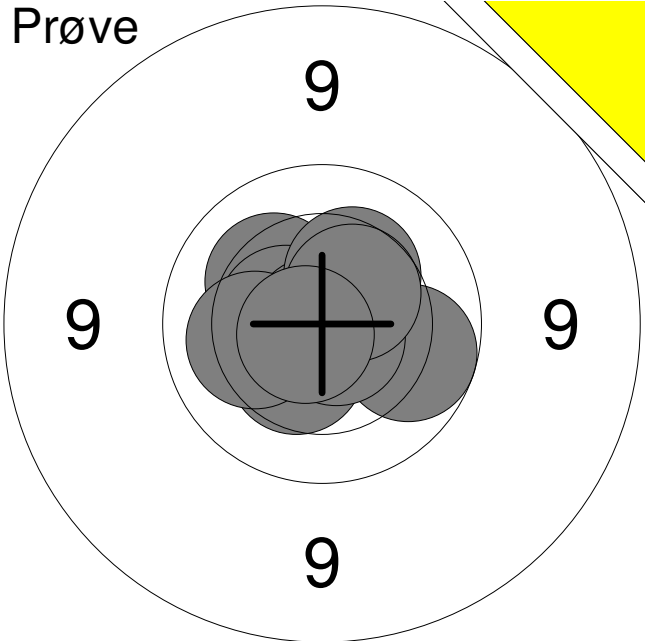
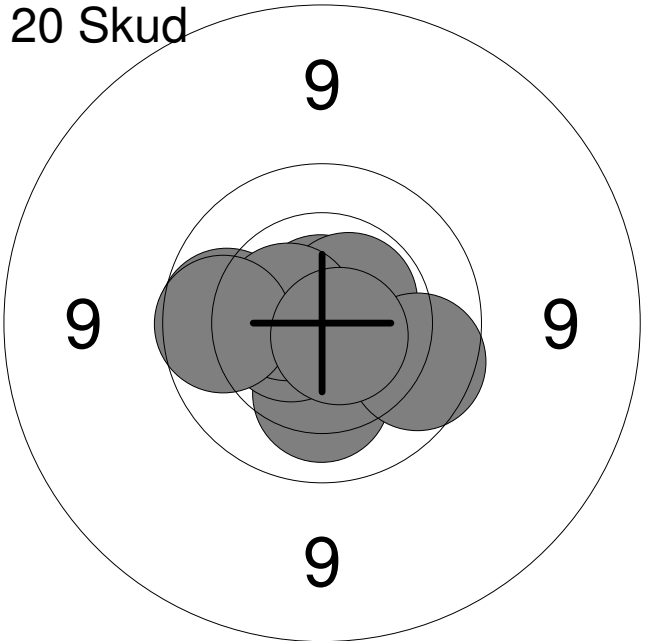
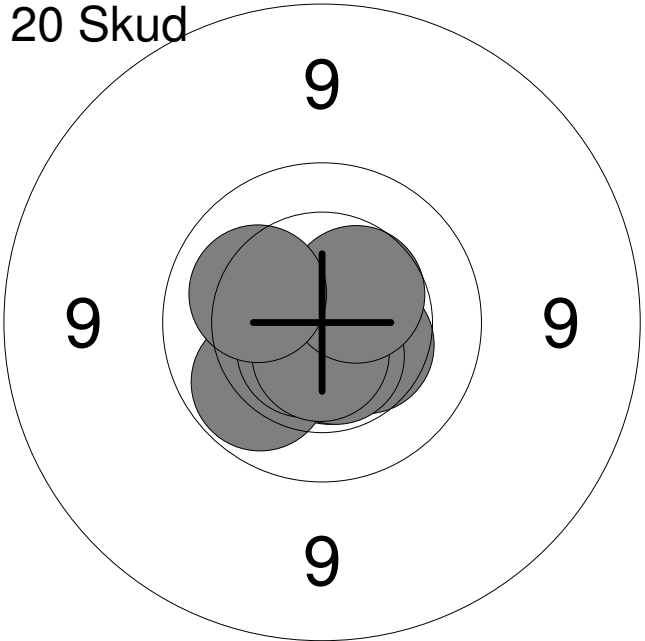
Hold 28	Skive 9	Kasper_Rebelski		
15 meter		Vilsted Skytteforening		MBK2
		Nordjysk mesterskab 2019	Aalborg Skyttekreds	
Prøve 	1:	9.9	→	
	2:	10.2	↗	
	3:	10.4	↓	
	4:	10.5x	←	
	5:	10.9x	←	
	6:	10.7x	↘	
	7:	10.3	↗	
	8:	10.5	↗	
	9:	10.2	←	
	10:	10.7x	↙	
	Serie			99 (4x)
Total			0 (0x)	
20 Skud 	1:	10.7x	↑	
	2:	10.7x	↓	
	3:	10.2	↓	
	4:	10.6x	↗	
	5:	9.9	→	
	6:	9.9	←	
	7:	10.6x	←	
	8:	10.6x	←	
	9:	9.9	←	
	10:	10.7x	↘	
	Serie			97 (6x)
Total			97 (6x)	
20 Skud 	11:	10.7x	←	
	12:	10.4	→	
	13:	10.4	←	
	14:	10.6x	↓	
	15:	10.0	↙	
	16:	10.5x	↓	
	17:	10.6x	↘	
	18:	10.6x	↓	
	19:	10.5	↗	
	20:	10.2	←	
	Serie			100 (5x)
Total			197 (11x)	

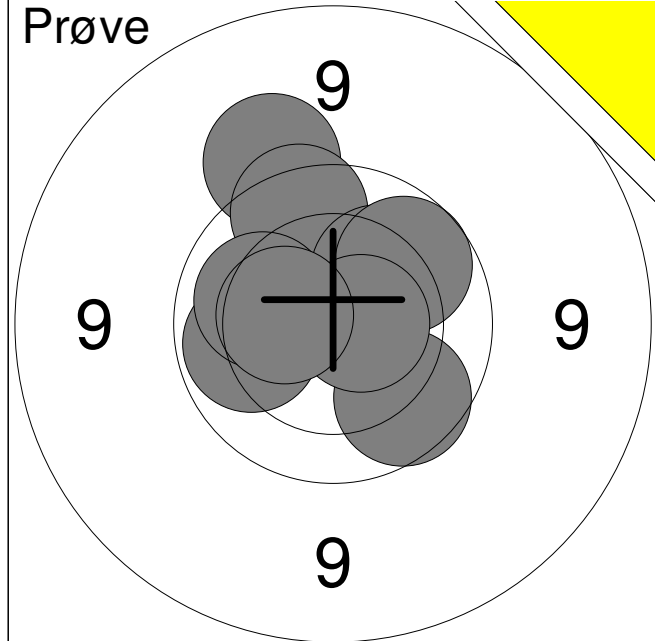

1:	9.4	↑
2:	9.8	↑
3:	9.9	↓
4:	10.2	↗
5:	10.0	←
6:	9.9	↗
7:	10.1	←
8:	10.6x	→
9:	10.4	←
Serie		86 (1x)
Total		0 (0x)

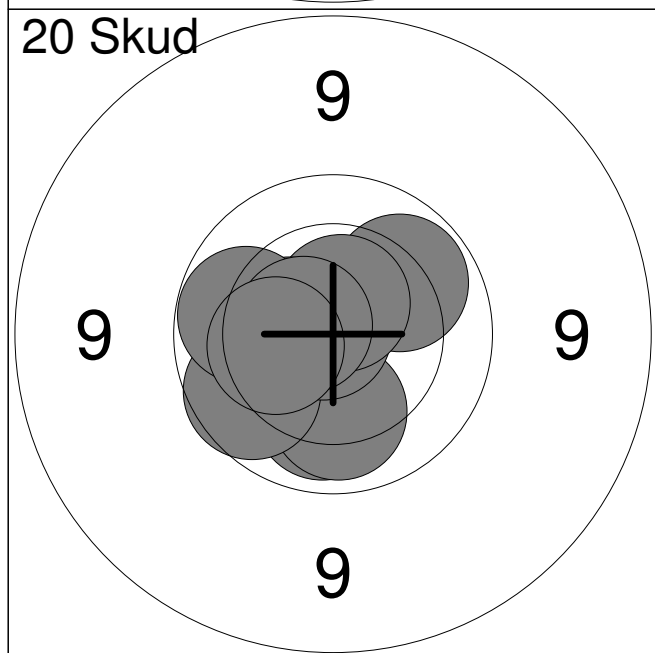

1:	10.1	↓
2:	10.0	↗
3:	10.1	↓
4:	9.9	←
5:	10.8x	←
6:	10.6x	↑
7:	10.5	←
8:	10.0	←
9:	10.6x	←
10:	10.3	←
Serie		99 (3x)
Total		99 (3x)

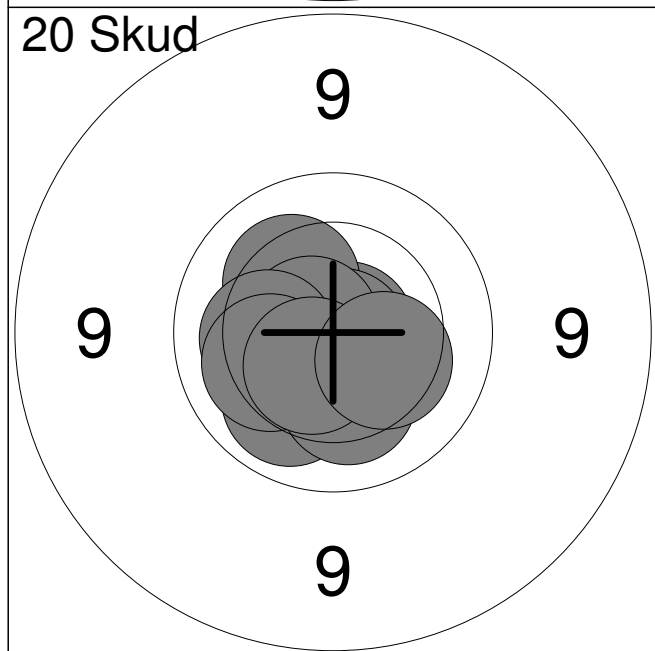

11:	10.8x	→
12:	10.2	↗
13:	10.1	↓
14:	10.9x	↓
15:	10.7x	←
16:	10.2	←
17:	10.2	↓
18:	10.2	←
19:	10.5x	↓
20:	10.3	↘
Serie		100 (4x)
Total		199 (7x)

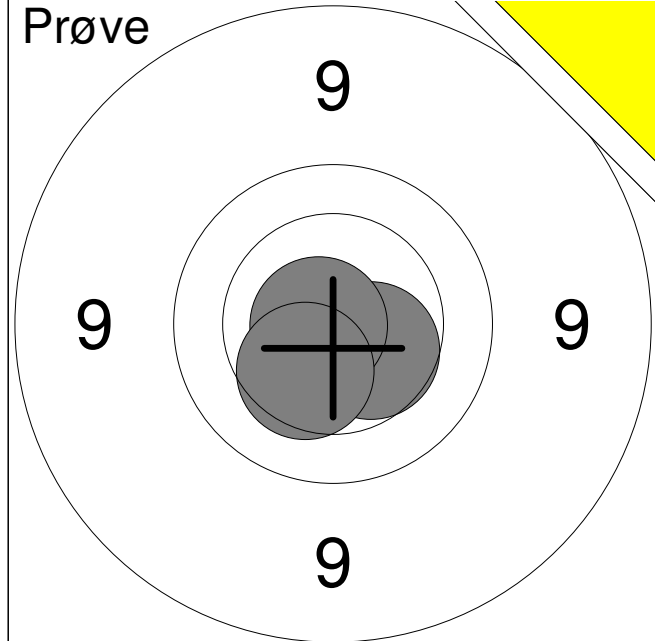

1:	10.7x	↓
2:	10.4	↘
3:	10.8x	←
4:	10.3	↙
Serie		40 (2x)
Total		0 (0x)

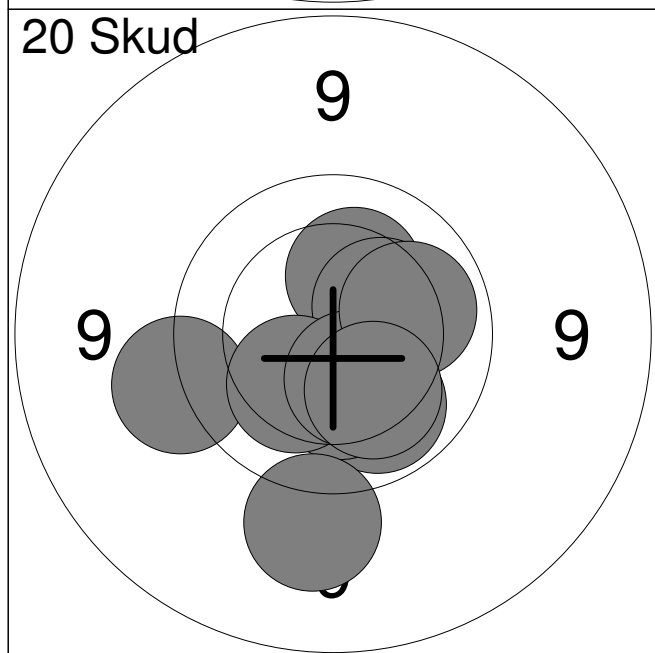

1:	10.3	↑
2:	10.0	↘
3:	10.3	↓
4:	9.5	←
5:	9.3	↓
6:	10.3	↗
7:	10.3	↙
8:	10.4	↓
9:	10.1	→
10:	10.2	↘
Serie		98 (0x)
Total		98 (0x)

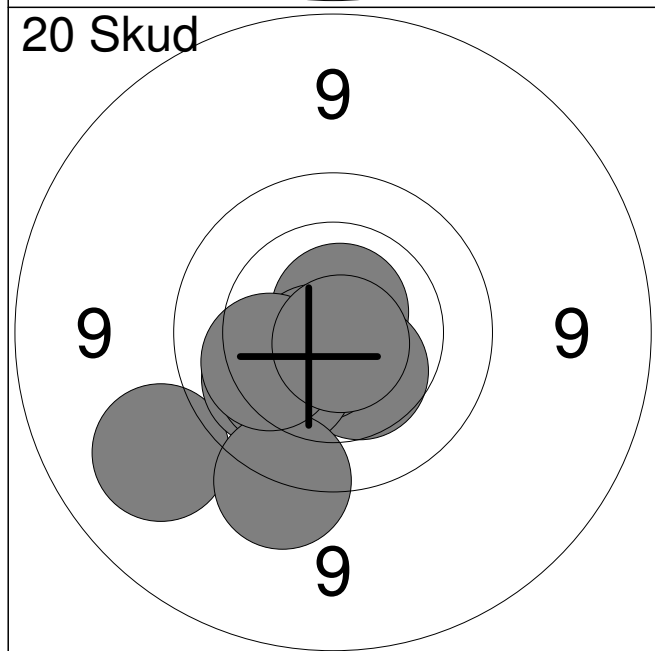

11:	10.7x	↑
12:	9.2	←
13:	10.1	←
14:	10.6x	↓
15:	10.4	↘
16:	10.7x	↙
17:	10.2	←
18:	9.5	↓
19:	10.2	←
20:	10.8x	↘
Serie		98 (4x)
Total		196 (4x)

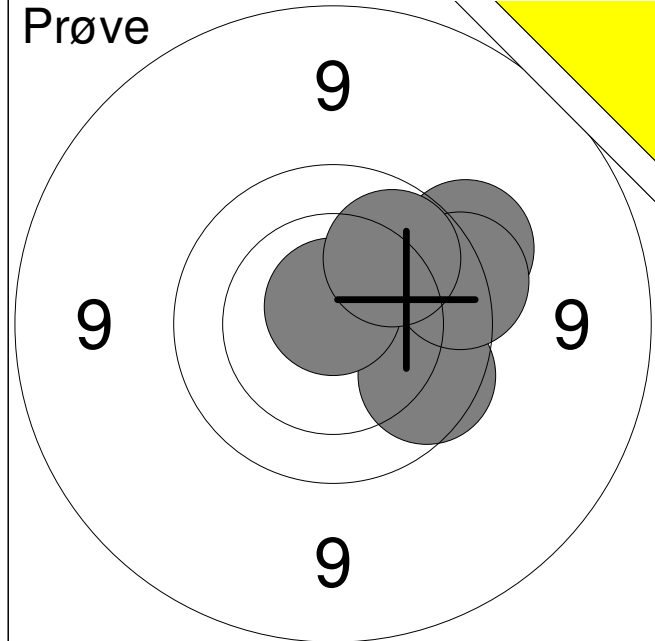

1:	9.6	↗
2:	9.8	↘
3:	10.8x	↑
4:	9.7	→
5:	10.0	↗
Serie		47 (1x)
Total		0 (0x)

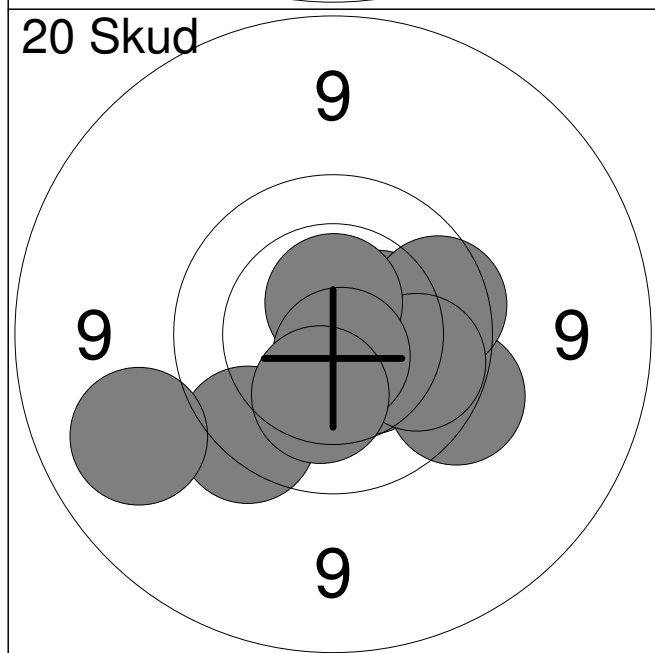

1:	10.4	↘
2:	10.4	→
3:	9.7	↘
4:	9.8	→
5:	10.0	→
6:	10.6x	↑
7:	9.7	↙
8:	9.1	↙
9:	10.7x	↓
10:	10.3	↓
Serie		96 (2x)
Total		96 (2x)

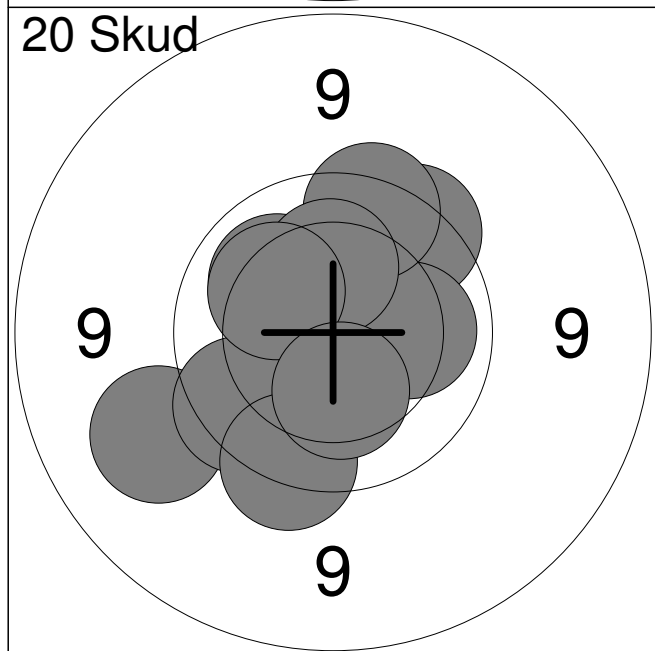

11:	9.2	↙
12:	9.7	↗
13:	10.1	→
14:	10.1	↖
15:	9.8	↙
16:	9.7	↓
17:	9.7	↑
18:	10.2	↑
19:	10.2	↖
20:	10.3	↓
Serie		95 (0x)
Total		191 (2x)

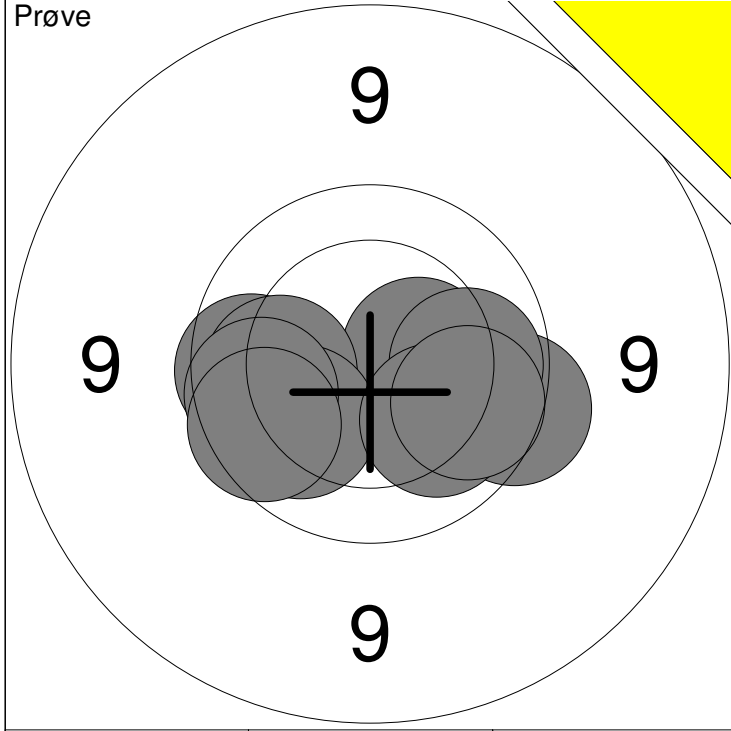

1: 9.9 ←	6: 10.0 →	Serie	95 (0x)
2: 10.5 →	7: 10.1 ↘		
3: 10.1 ←	8: 9.9 ↘	Total	0 (0x)
4: 10.1 ↙	9: 9.9 ←		
5: 9.7 →	10: 9.8 ↙		

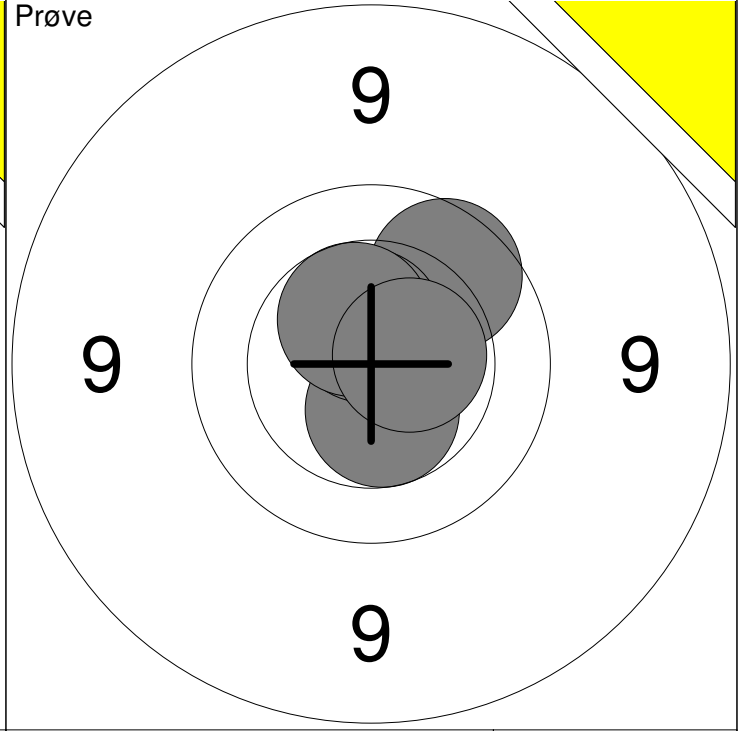

11: 10.5 ↓	Serie	49 (2x)
12: 9.9 ↗		
13: 10.6x ↑	Total	0 (0x)
14: 10.5 ↗		
15: 10.6x →		

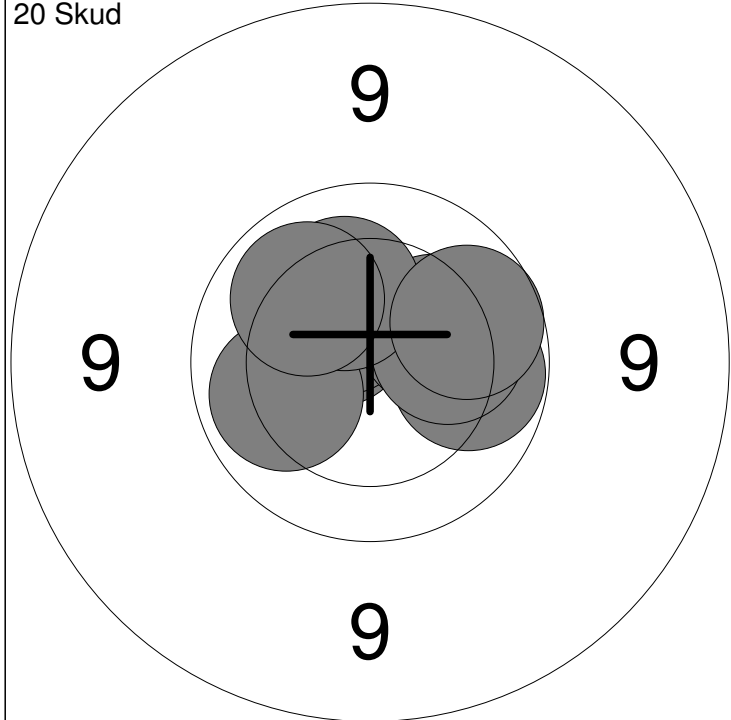

1: 10.3 ↗	6: 10.2 →	Serie	99 (0x)
2: 10.5 ↗	7: 10.2 →		
3: 10.4 ↗	8: 10.2 ↗	Total	99 (0x)
4: 10.1 ←	9: 10.1 ↗		
5: 10.0 →	10: 9.9 →		

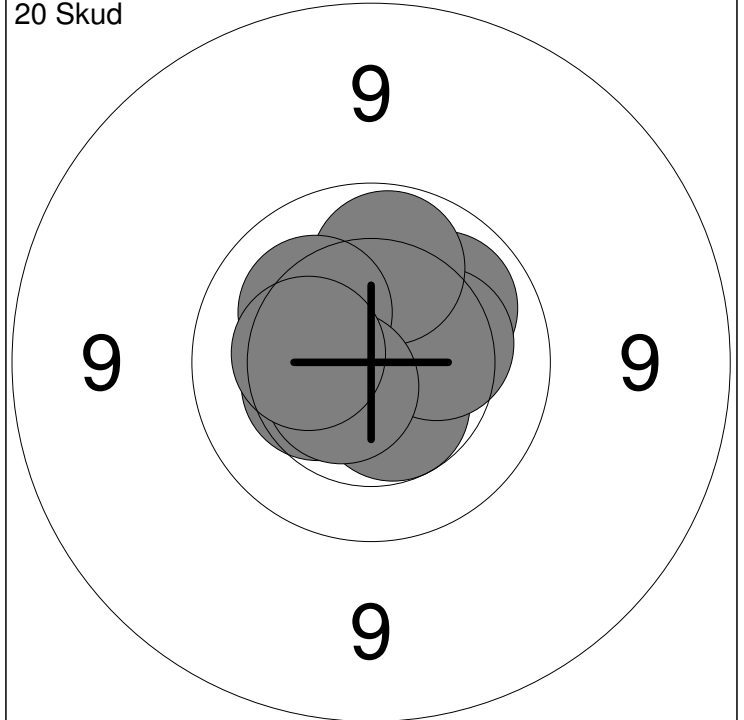

11: 10.4 ←	16: 10.3 →	Serie	100 (2x)
12: 10.1 ↗	17: 10.0 ↑		
13: 10.5 ↑	18: 10.2 ↙	Total	199 (2x)
14: 10.5 ↓	19: 10.6x ↙		
15: 10.8x ←	20: 10.3 ←		

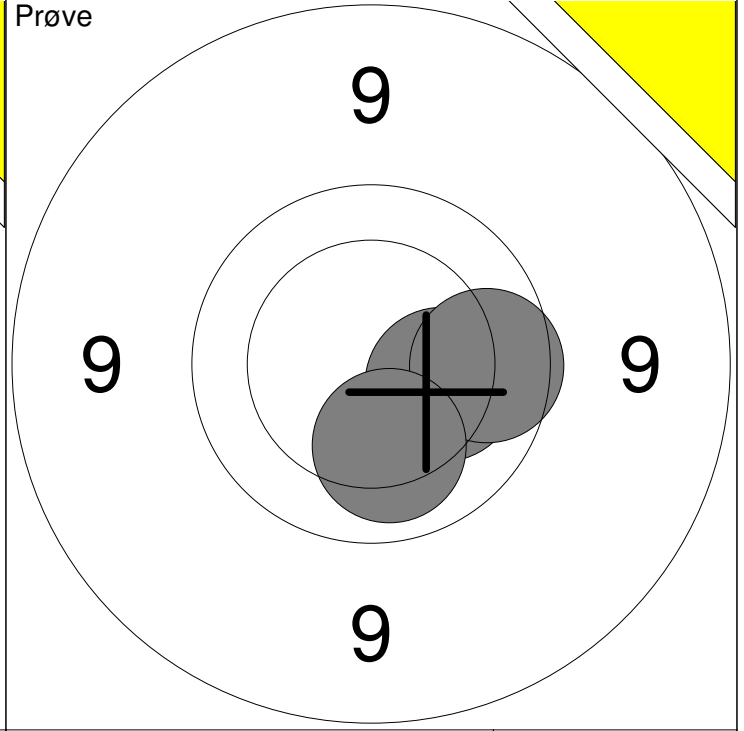
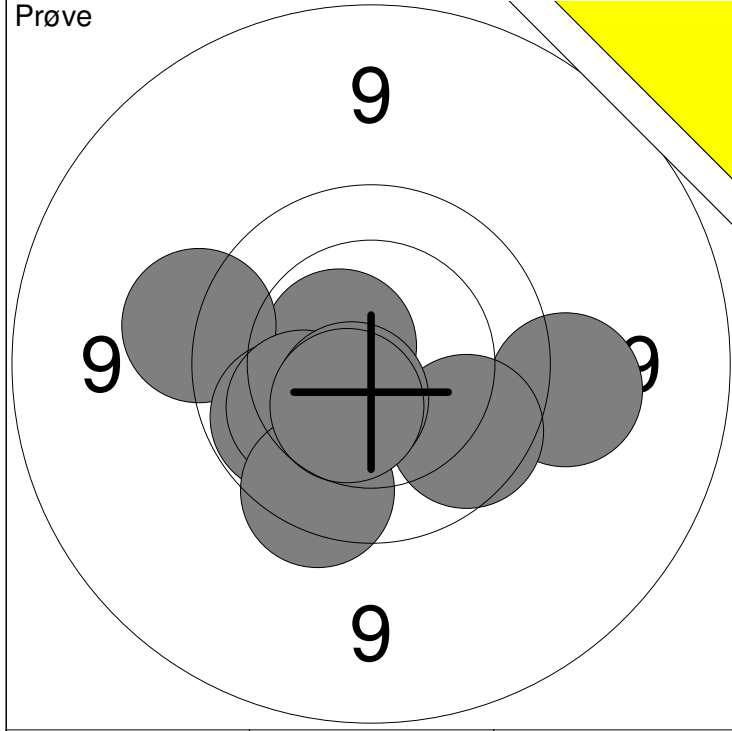

1: 9.4 →	6: 10.0 ←	Serie	96 (2x)
2: 9.9 ↘	7: 10.2 ←		
3: 10.4 ←	8: 9.8 ↓	Total	0 (0x)
4: 10.6x ↗	9: 10.6x ↓		
5: 9.5 ←	10: 10.5 ↓		

11: 10.2 →	Serie	29 (0x)
12: 9.9 →		
13: 10.1 ↓	Total	0 (0x)

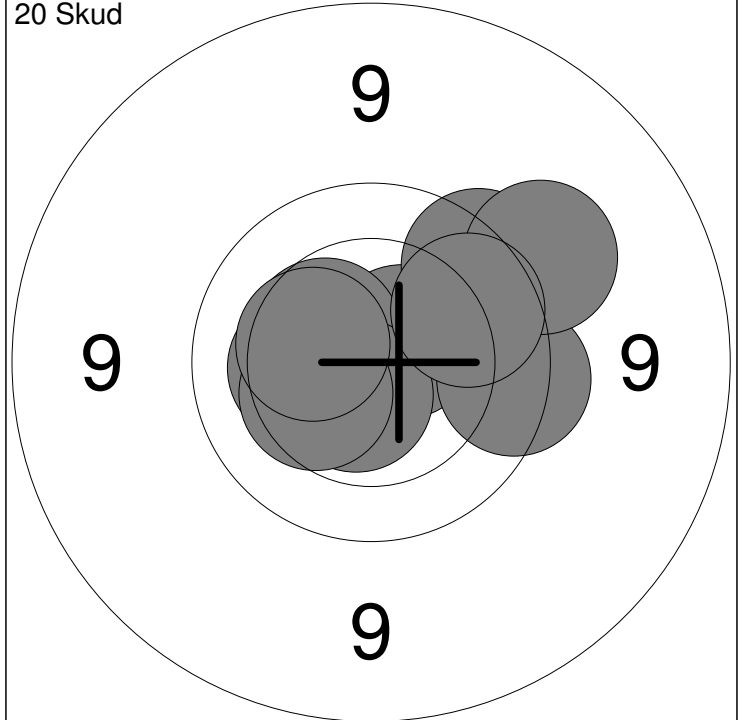
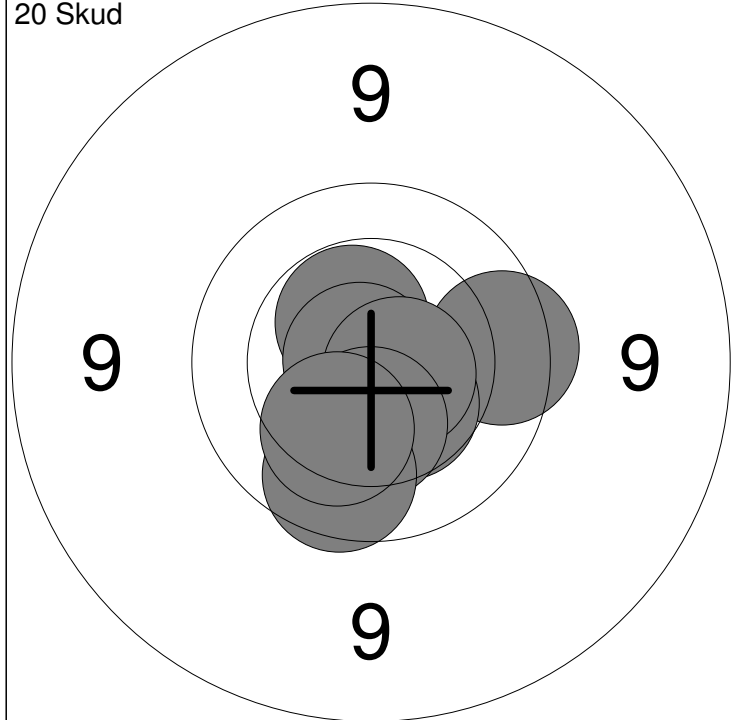

1: 10.5 ↓	6: 10.5 ↓	Serie	98 (3x)
2: 10.5x ↗	7: 10.7x →		
3: 10.4 ↓	8: 10.3 ↓	Total	98 (3x)
4: 10.8x ←	9: 9.9 ↓		
5: 9.8 →	10: 10.2 ↓		

11: 10.3 ←	16: 10.3 ←	Serie	96 (2x)
12: 10.6x ↗	17: 9.7 →		
13: 10.4 ←	18: 9.4 ↗	Total	194 (5x)
14: 9.7 ↗	19: 10.4 ←		
15: 10.6x ↓	20: 9.9 ↗		

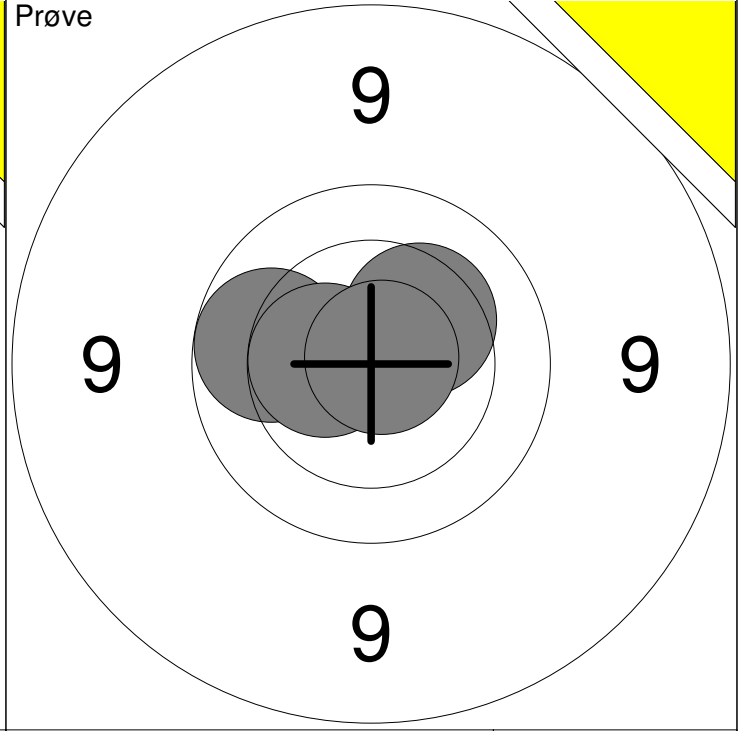
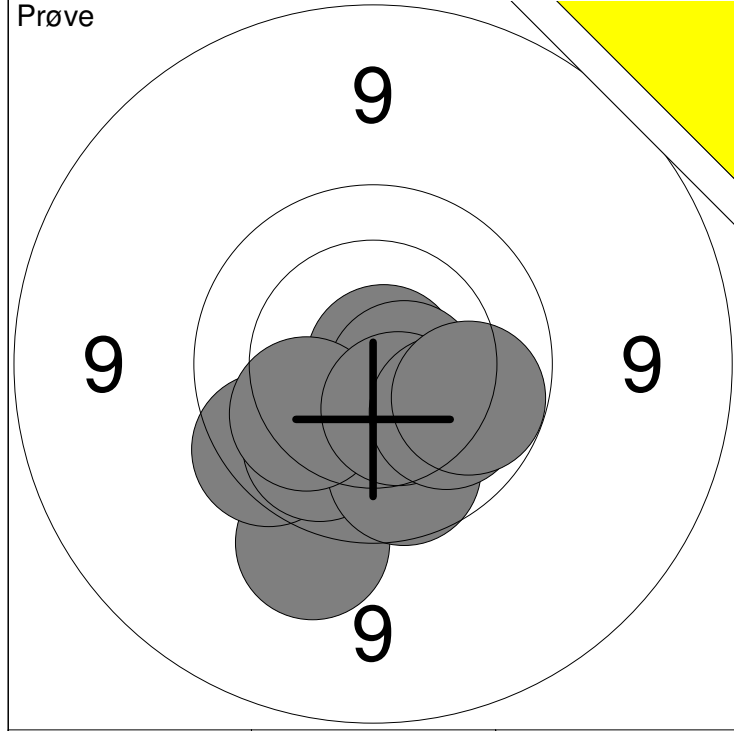

1: 9.5 ↘	6: 10.6x →	Serie	97 (2x)
2: 9.8 ↙	7: 10.1 ↙		
3: 10.0 ↙	8: 10.5 ↘	Total	0 (0x)
4: 9.9 ↘	9: 10.1 ↘		
5: 10.8x →	10: 10.0 →		

11: 10.0 ←	Serie	40 (2x)
12: 10.3 ↗		
13: 10.5x ←	Total	0 (0x)
14: 10.8x ↗		

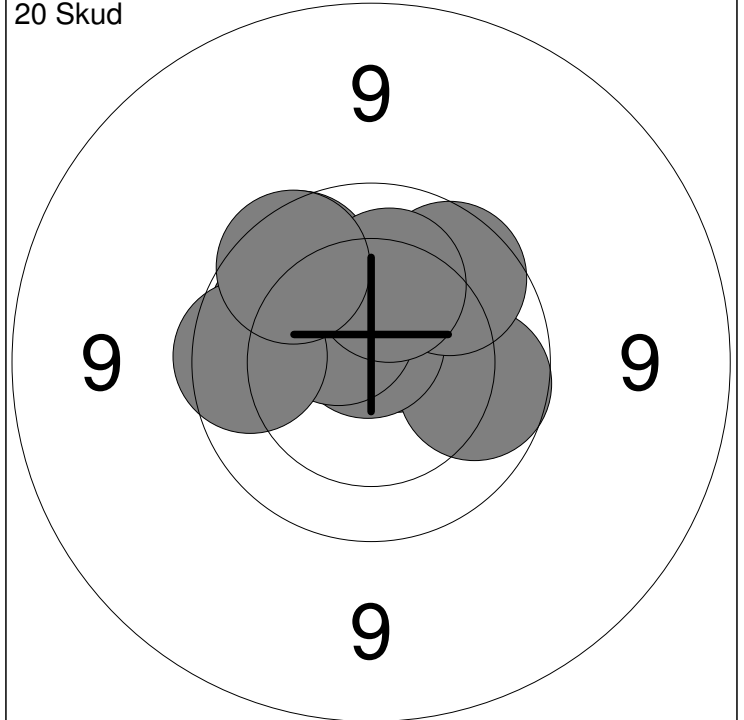
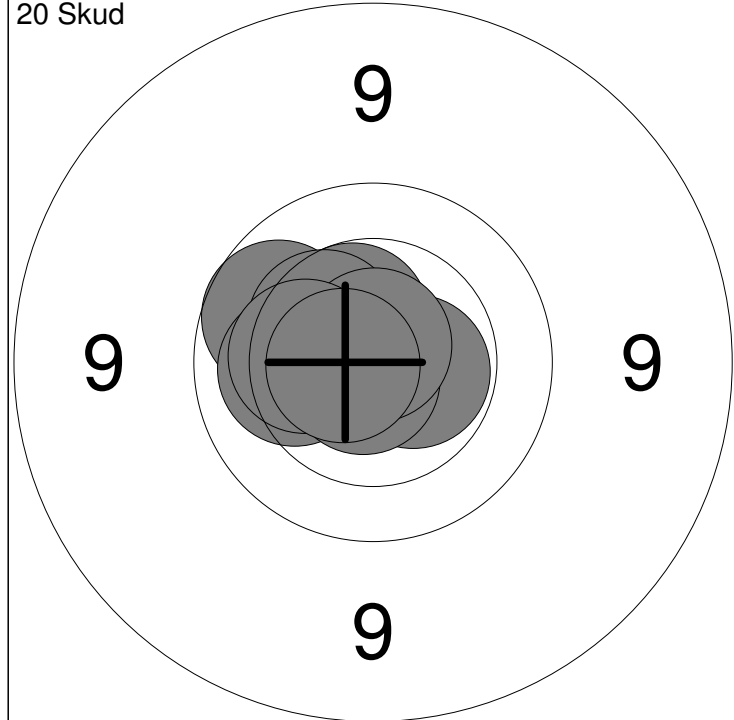

1: 9.9 ↗	6: 10.2 ←	Serie	99 (5x)
2: 10.5x →	7: 10.8x ↘		
3: 10.5 ↗	8: 10.8x ↑	Total	99 (5x)
4: 10.4 ↗	9: 10.3 ←		
5: 10.8x ↗	10: 10.7x ←		

11: 10.0 ←	16: 10.5 ↗	Serie	95 (2x)
12: 10.6x ↗	17: 9.9 ↗		
13: 9.9 →	18: 9.8 ←	Total	194 (7x)
14: 10.7x ↑	19: 10.2 ↑		
15: 9.9 ↗	20: 9.8 ↗		

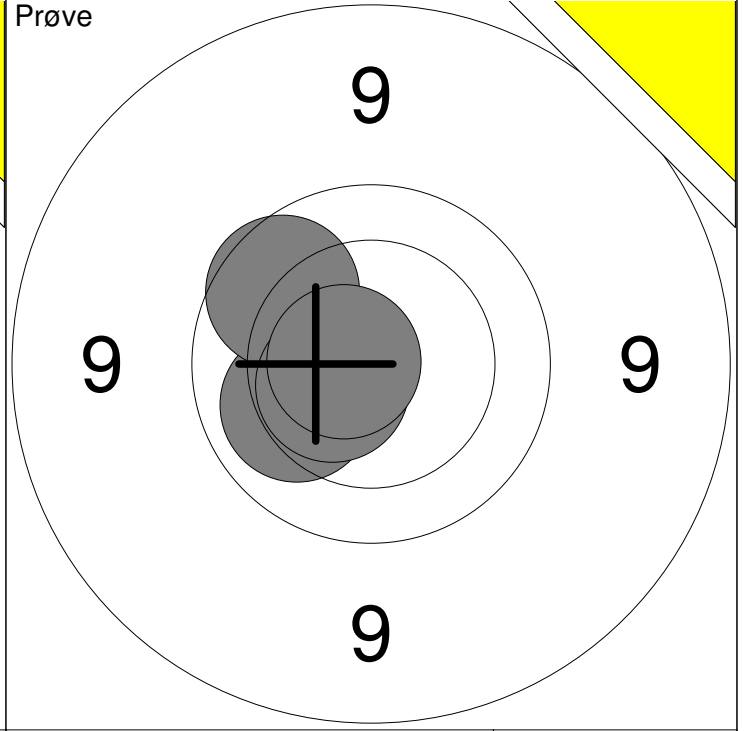
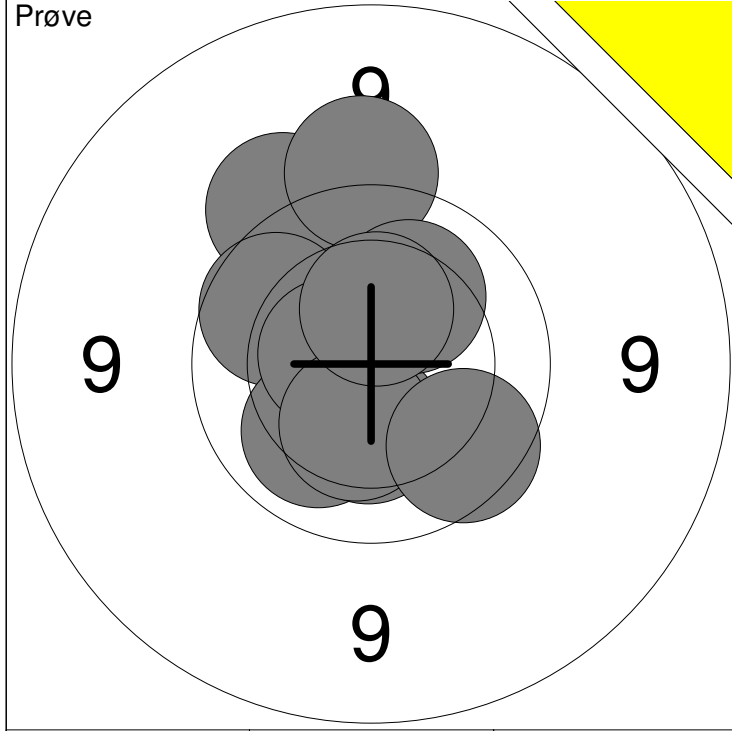

1: 9.5 ↗	6: 9.5 ↑	Serie 96 (1x)
2: 9.9 ↖	7: 10.2 ↗	
3: 10.1 ↘	8: 10.3 ↓	Total 0 (0x)
4: 10.3 ↓	9: 9.8 ↘	
5: 10.6x ←	10: 10.4 ↑	

11: 10.1 ←	Serie 39 (2x)
12: 9.9 ↖	
13: 10.5x ←	Total 0 (0x)
14: 10.7x ←	

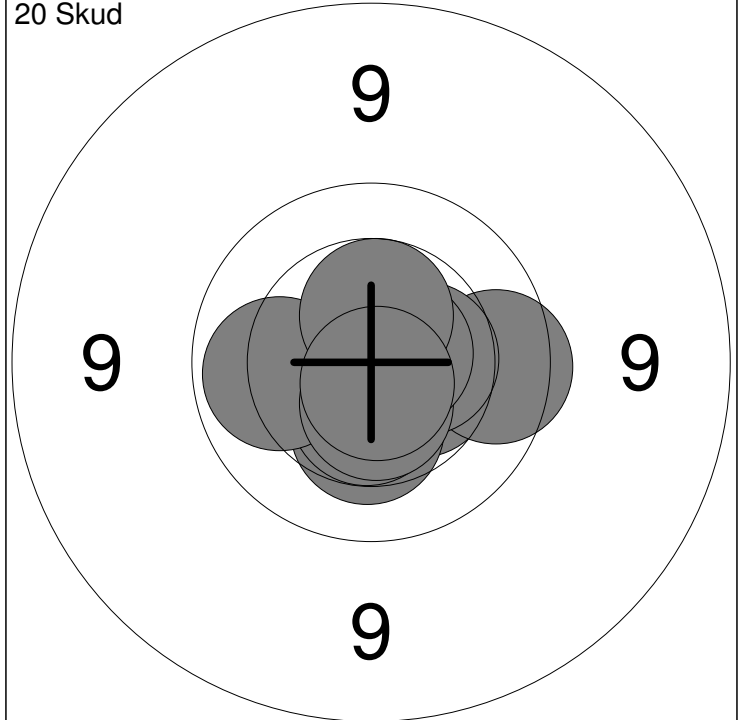
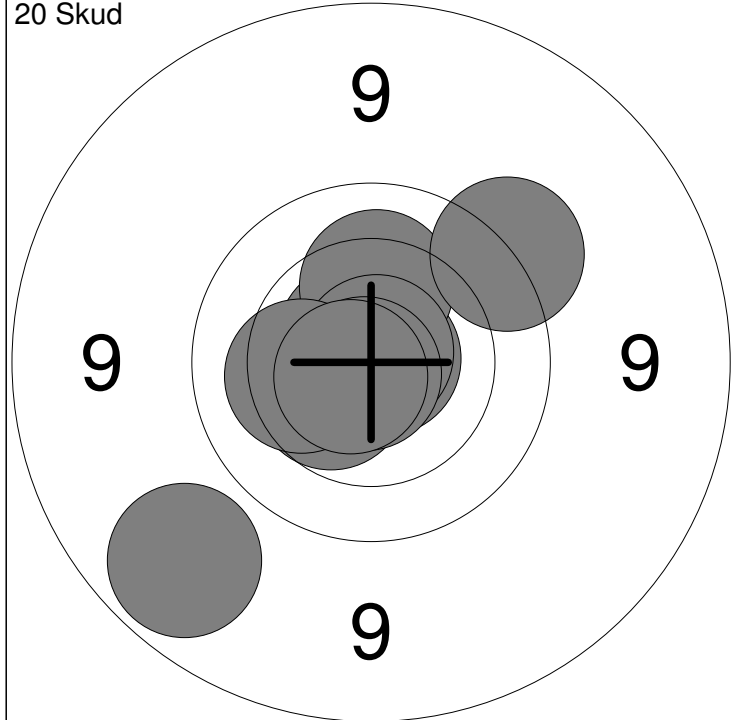

1: 10.7x ↗	6: 9.0 ←	Serie 98 (5x)
2: 10.8x →	7: 10.3 ←	
3: 10.2 ↑	8: 9.5 ↗	Total 98 (5x)
4: 10.8x ↗	9: 10.8x ↓	
5: 10.5 ←	10: 10.7x ←	

11: 10.5 →	16: 10.0 ←	Serie 99 (5x)
12: 10.3 ↓	17: 10.5x ↓	
13: 10.5x ↓	18: 10.7x →	Total 197 (10x)
14: 9.8 →	19: 10.5x ↑	
15: 10.5 →	20: 10.7x ↓	

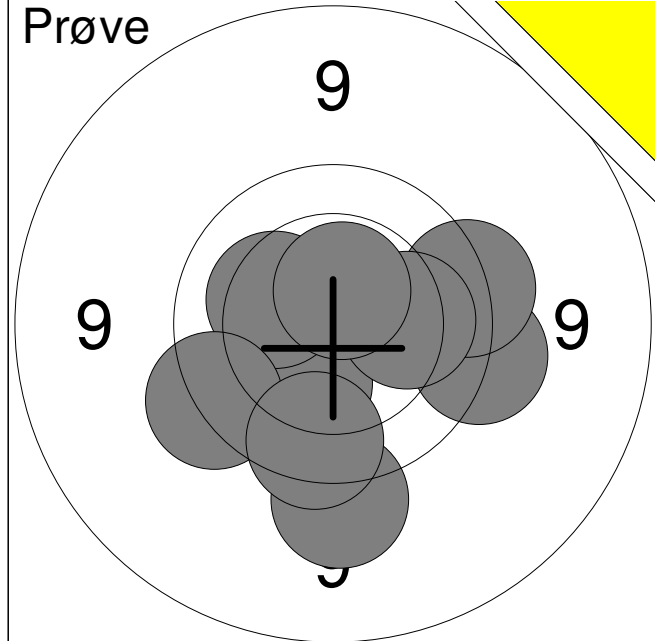

1:	9.6	→
2:	10.2	↓
3:	9.4	↓
4:	10.2	←
5:	9.6	←
6:	9.8	↓
7:	9.6	→
8:	10.1	→
9:	10.6x	↑
Serie		85 (1x)
Total		0 (0x)

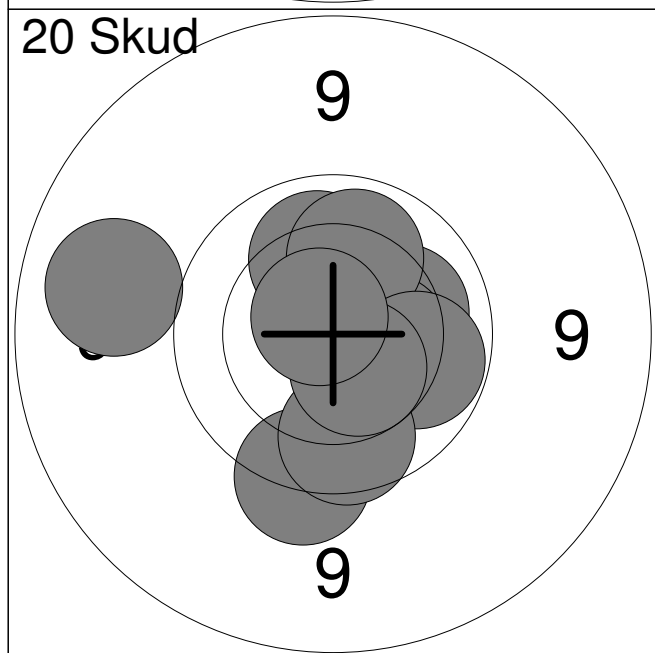

1:	10.1	↑
2:	10.2	→
3:	9.6	↓
4:	10.4	→
5:	10.1	↑
6:	10.0	→
7:	9.9	↓
8:	10.5	↓
9:	9.1	←
10:	10.7x	↗
Serie		97 (1x)
Total		97 (1x)

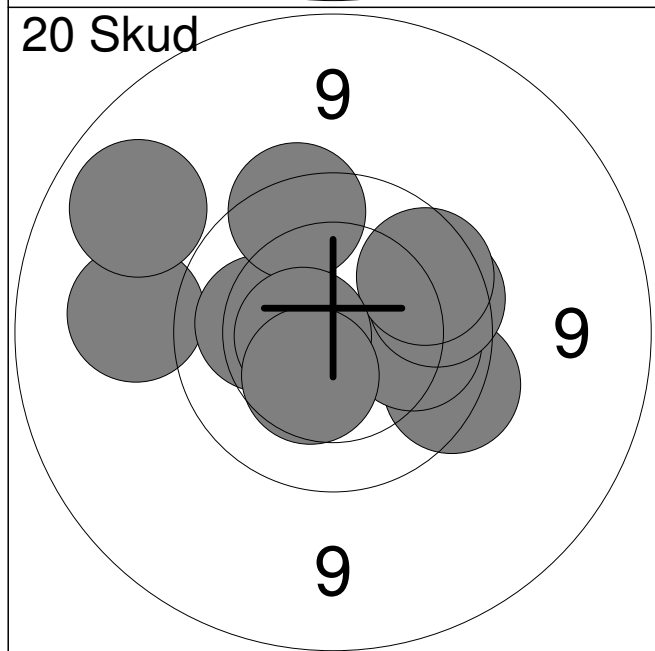

11:	9.3	←
12:	9.7	↘
13:	10.2	←
14:	9.7	↑
15:	10.1	→
16:	9.8	→
17:	9.8	↗
18:	9.1	↖
19:	10.6x	←
20:	10.4	↓
Serie		94 (1x)
Total		191 (2x)

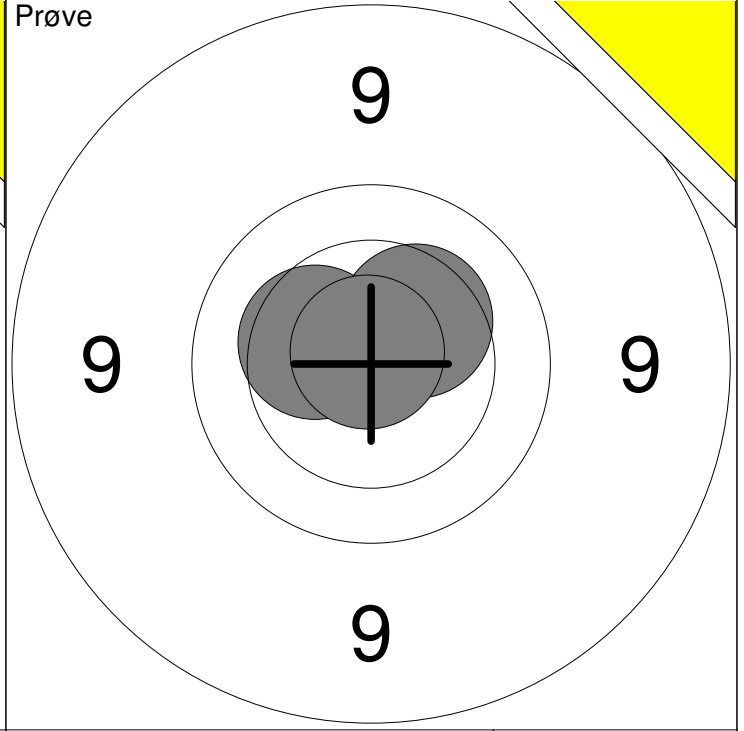
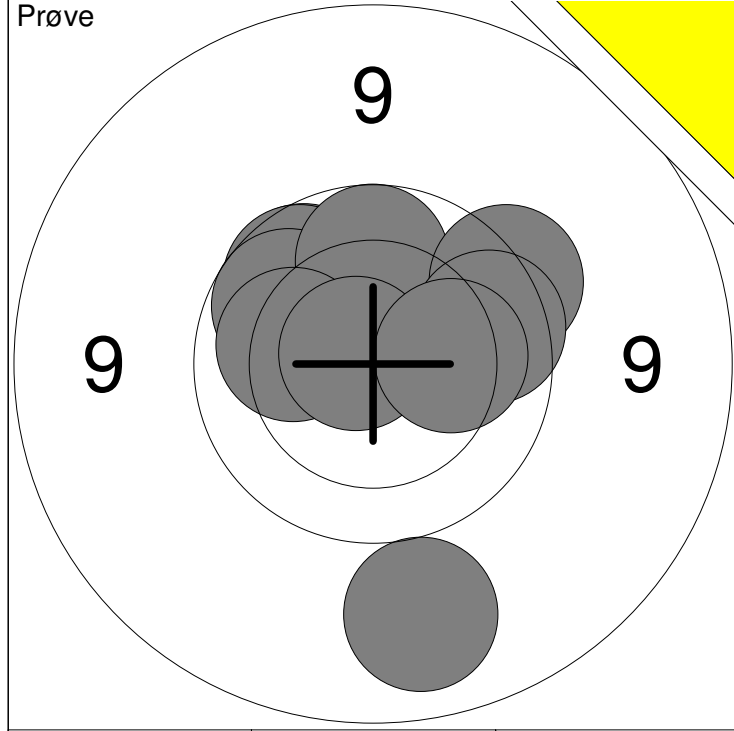

1: 9.1 ↓	6: 10.1 ←	Serie	93 (1x)
2: 9.9 ↗	7: 10.8x ↖		
3: 9.9 ↗	8: 9.6 ↗	Total	0 (0x)
4: 9.9 ↗	9: 9.8 →		
5: 9.9 ↑	10: 10.2 →		

11: 10.3 ↗	Serie	30 (1x)
12: 10.4 ↖		
13: 10.8x ↑	Total	0 (0x)

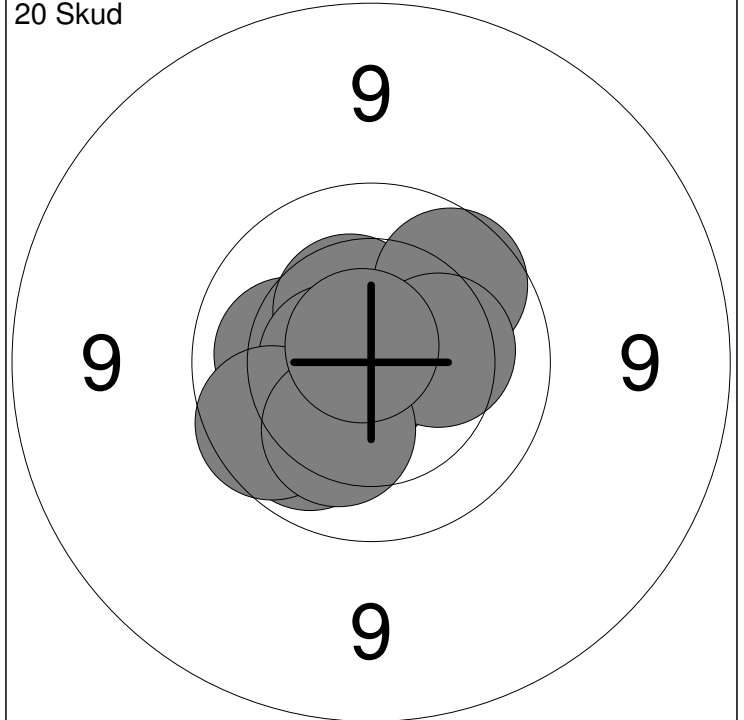
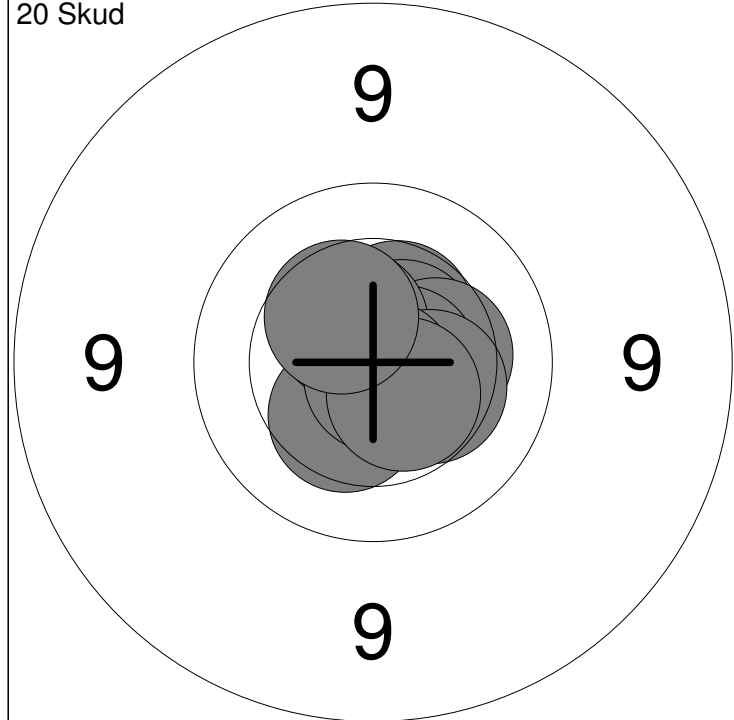

1: 10.5 ↗	6: 10.5x ↗	Serie	100 (5x)
2: 10.6x ↗	7: 10.4 →		
3: 10.3 →	8: 10.8x ↘	Total	100 (5x)
4: 10.4 ↘	9: 10.5x ↘		
5: 10.7x →	10: 10.4 ↗		

11: 10.8x ↘	16: 10.0 ↘	Serie	98 (3x)
12: 10.2 ←	17: 10.3 →		
13: 10.4 ↗	18: 9.9 ↖	Total	198 (8x)
14: 10.6x ←	19: 10.2 ↘		
15: 9.9 ↗	20: 10.8x ↖		

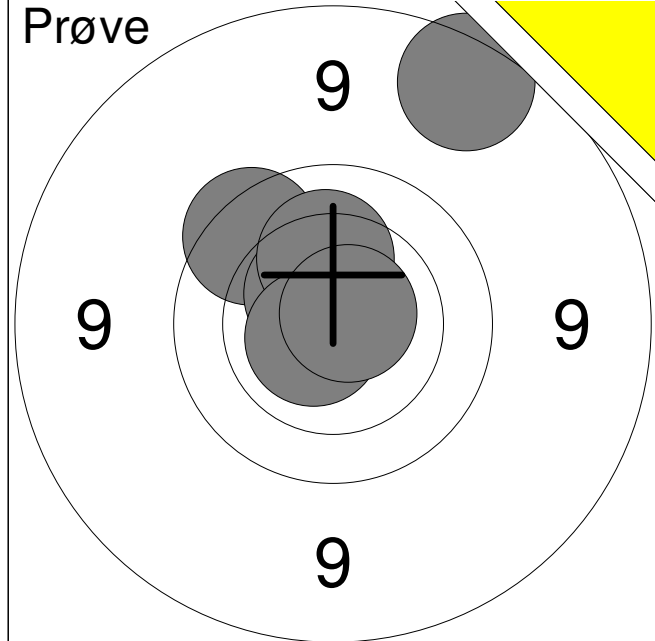

2:	8.8	↗
3:	9.8	↖
5:	10.6x	↗
6:	10.2	↑
7:	10.7x	↖
8:	10.7x	↗
Serie		57 (3x)
Total		0 (0x)

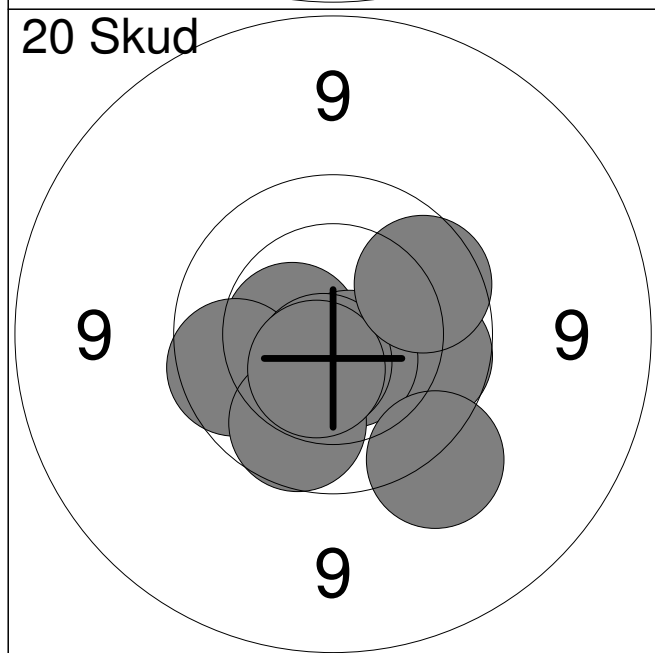

1:	10.5	↓
2:	9.9	→
3:	10.5x	←
4:	9.9	←
5:	10.6x	↓
6:	9.9	↓
7:	9.5	↓
8:	10.6x	↓
9:	10.5x	↓
10:	9.9	↗
Serie		95 (4x)
Total		95 (4x)

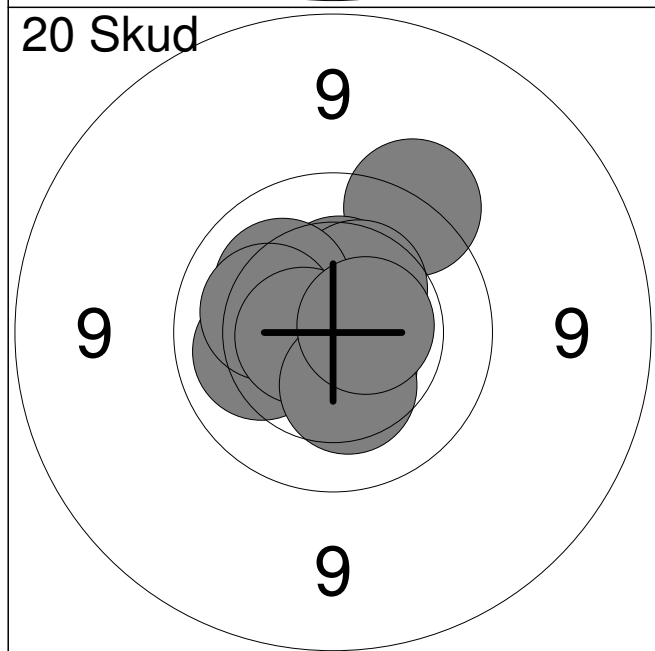

11:	9.6	↗
12:	10.4	↑
13:	10.4	↗
14:	10.1	←
15:	10.2	↗
16:	10.2	←
17:	10.5x	↓
18:	10.6x	←
19:	10.3	↓
20:	10.6x	→
Serie		99 (3x)
Total		194 (7x)

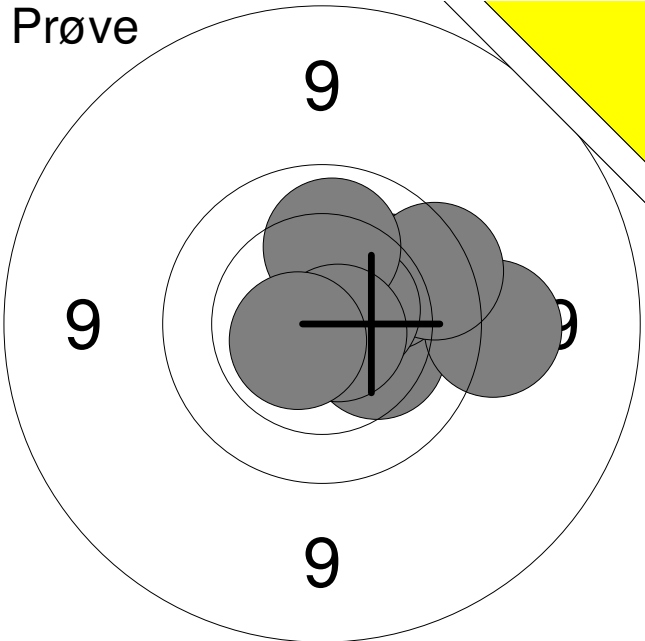
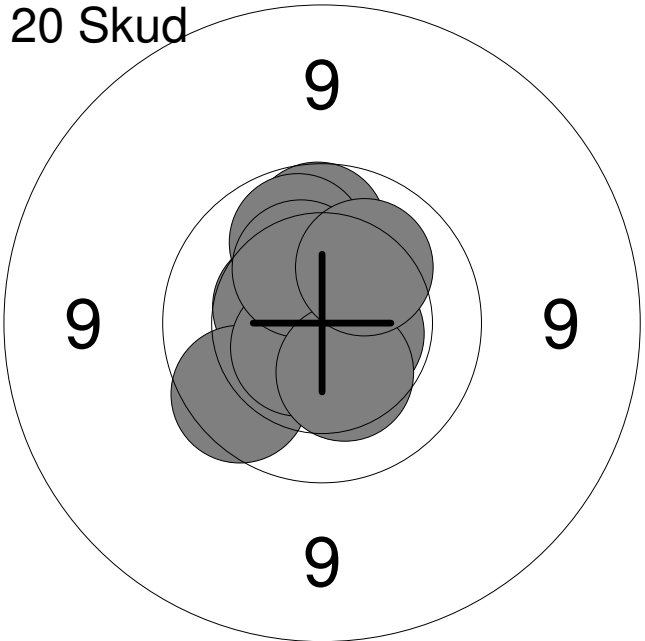
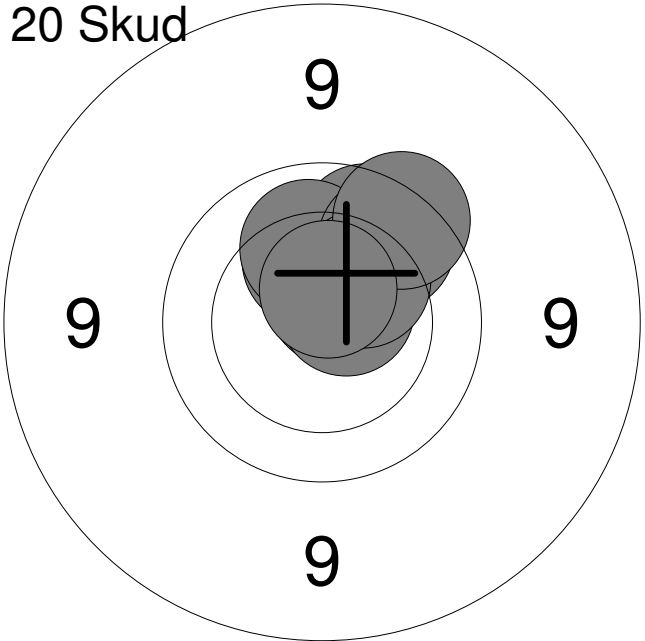
Hold 29	Skive 8	Mille Marie Frederiksen	
15 meter		Sæby og omegns skytteforening	MJ2
		Nordjysk mesterskab 2019	Aalborg Skyttekreds
Prøve 	1:	10.2	➔
	2:	10.8x	⚡
	3:	10.3	➔
	4:	10.1	➔
	5:	9.4	➔
	6:	9.7	➔
	7:	10.6x	➔
	8:	10.1	⬆
	9:	10.8x	⚡
	10:	10.6x	⚡
	Serie		98 (4x)
Total		0 (0x)	
20 Skud 	1:	10.6x	➔
	2:	10.5	⚡
	3:	10.5	⬆
	4:	9.9	⬆
	5:	10.0	⬆
	6:	9.8	⚡
	7:	10.6x	⚡
	8:	10.3	⬆
	9:	10.3	⚡
	10:	10.2	➔
	Serie		98 (2x)
Total		98 (2x)	
20 Skud 	11:	10.1	➔
	12:	10.2	⬆
	13:	10.6x	➔
	14:	9.9	➔
	15:	10.1	⬆
	16:	9.9	➔
	17:	10.6x	➔
	18:	10.3	➔
	19:	9.7	➔
	20:	10.6x	⬆
	Serie		97 (3x)
Total		195 (5x)	

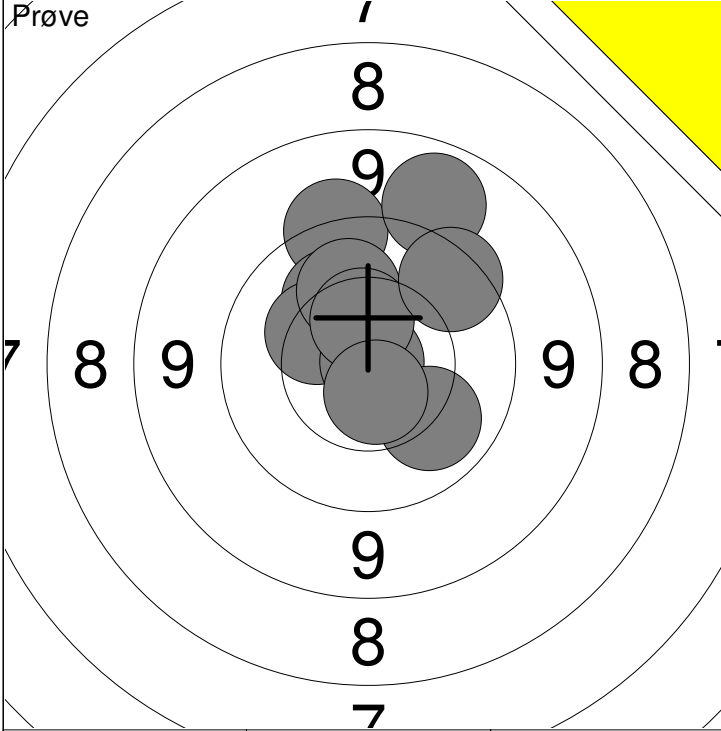

1: 9.5 ↑	6: 10.9x ↗
2: 9.1 ↑	7: 10.5 ↑
3: 10.2 ↗	8: 9.7 ↗
4: 10.3 ↖	9: 10.1 ↘
5: 10.2 ↑	10: 10.6x ↓

Serie	97 (2x)
Total	0 (0x)

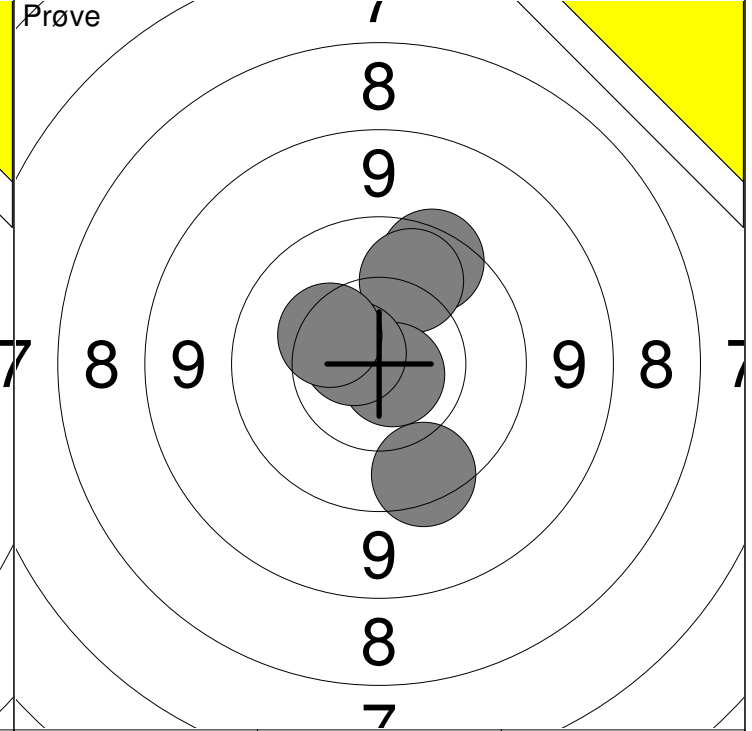

11: 9.7 ↑	12: 10.0 ↑
13: 9.7 ↓	14: 10.8x ↘
15: 10.7x ↖	

Serie	58 (2x)
Total	0 (0x)

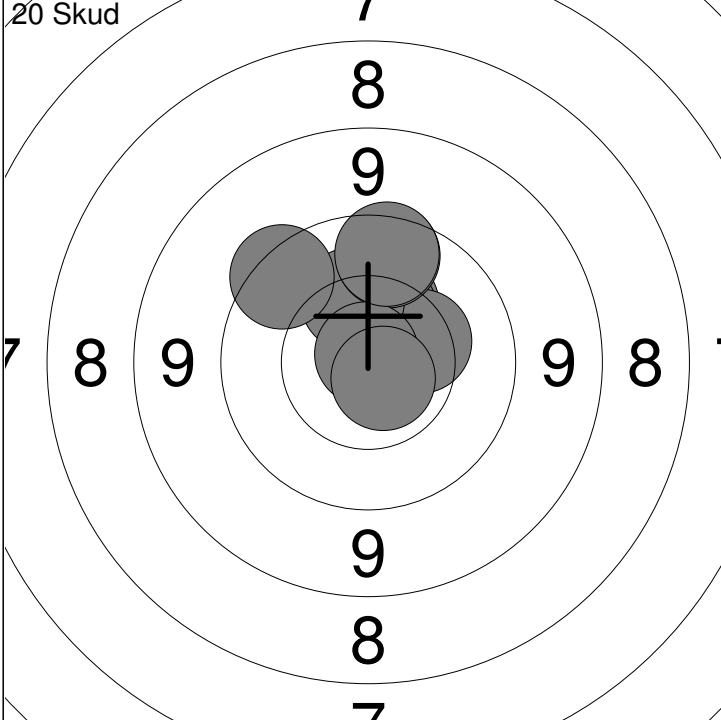

1: 10.3 ↑	6: 9.8 ↑
2: 10.4 ↑	7: 10.9x ↑
3: 10.7x ↗	8: 10.7x ↘
4: 10.4 ↗	9: 9.6 ↖
5: 10.3 ↑	10: 9.8 ↑

Serie	97 (3x)
Total	97 (3x)

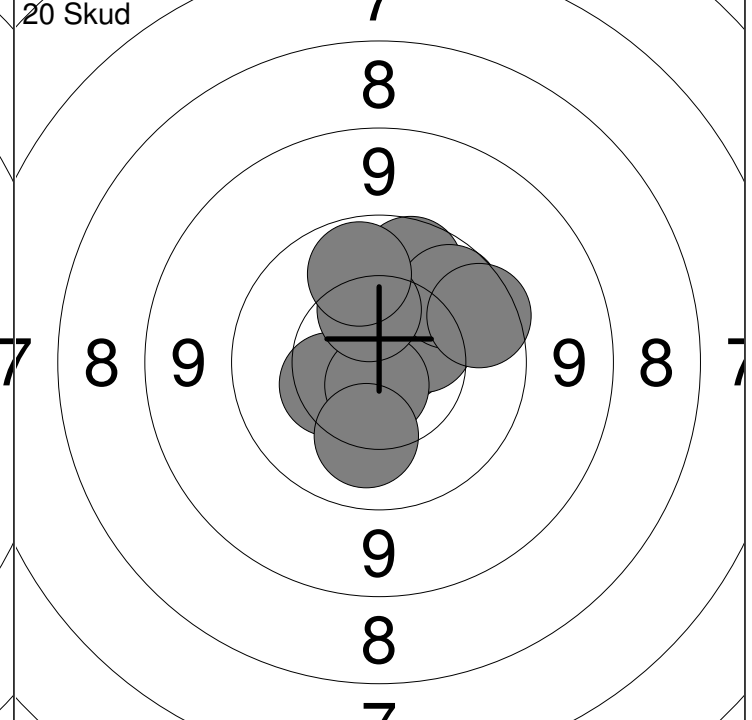

11: 10.7x ↗	12: 10.5 ↗
13: 9.9 ↑	14: 9.9 ↗
15: 10.4 ↖	

Serie	97 (2x)
Total	194 (5x)

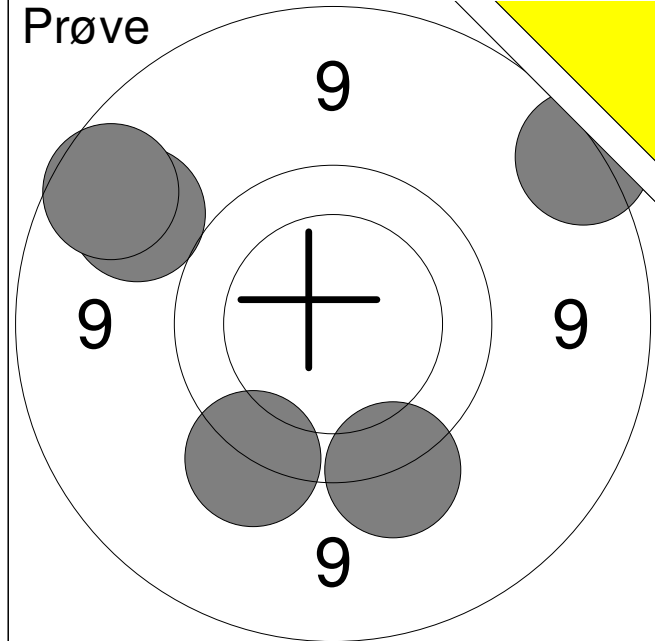

1:	9.5	↓
2:	9.5	↓
3:	8.7	↗
4:	9.1	↖
5:	8.9	↖
Serie		43 (0x)
Total		0 (0x)

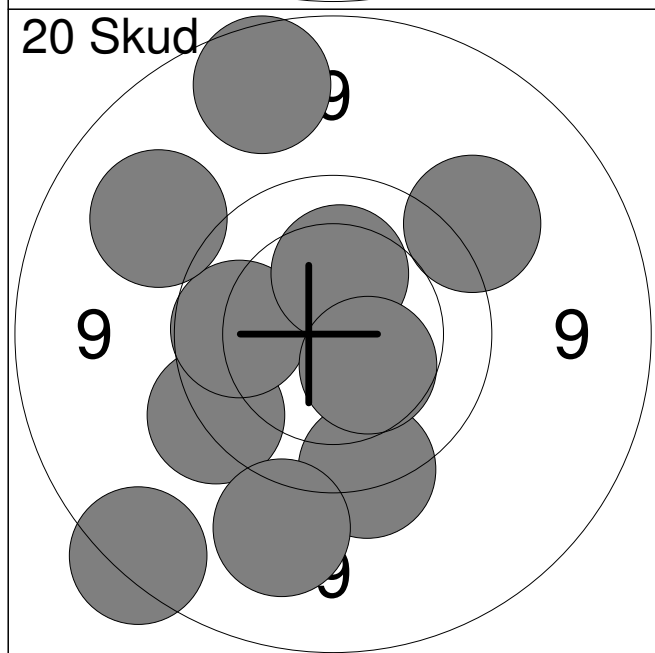

1:	9.6	↙
2:	8.9	↑
3:	9.9	←
4:	10.3	↑
5:	9.6	↓
6:	8.8	↙
7:	10.4	↘
8:	9.3	↓
9:	9.2	↖
10:	9.4	↗
Serie		90 (0x)
Total		90 (0x)

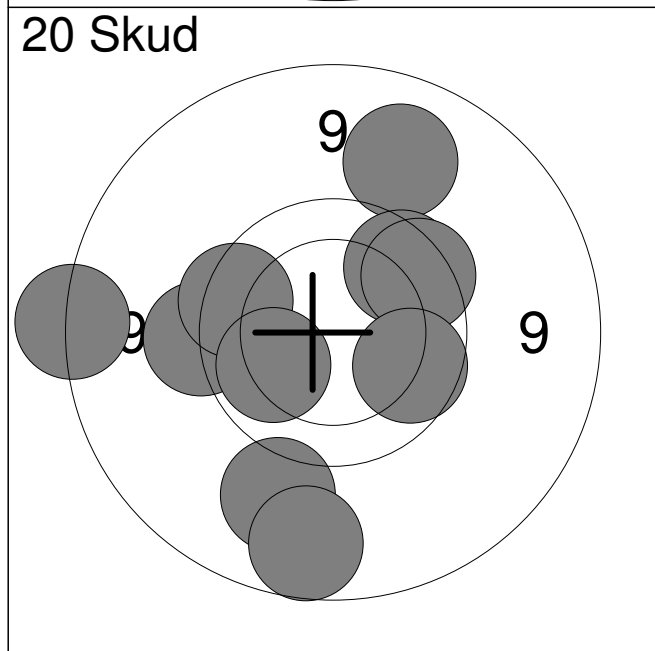

11:	9.1	↑
12:	9.5	←
13:	9.8	↗
14:	9.8	←
15:	9.2	↓
16:	10.1	↙
17:	9.8	↗
18:	9.9	↘
19:	8.7	←
20:	8.9	↓
Serie		89 (0x)
Total		179 (0x)

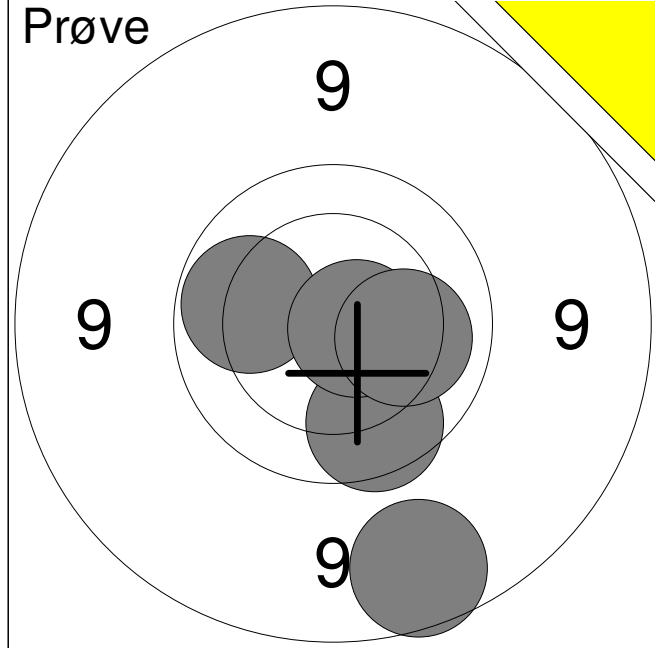

1:	10.0	←
2:	9.8	↘
3:	8.9	↘
4:	10.7x	→
5:	10.2	→
Serie		47 (1x)
Total		0 (0x)

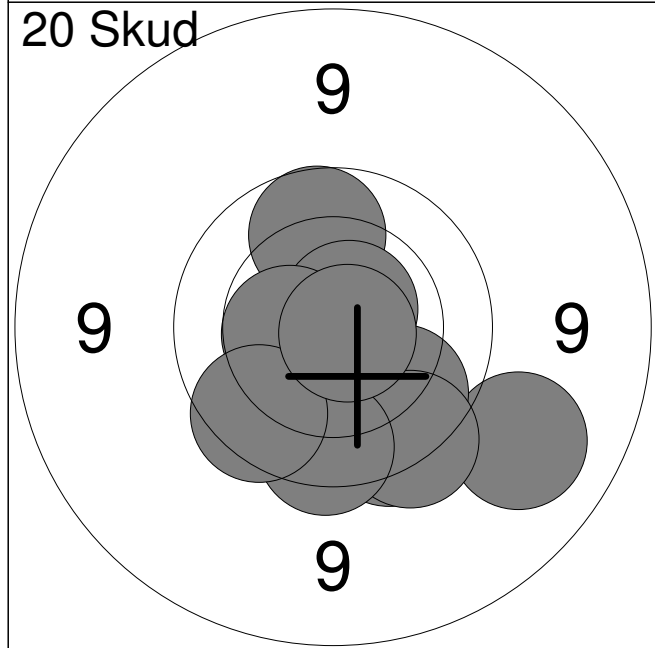

1:	9.2	↘
2:	9.7	↘
3:	9.9	↘
4:	9.7	↘
5:	9.8	↘
6:	9.9	↑
7:	10.7x	↗
8:	10.5	←
9:	9.8	↘
10:	10.8x	→
Serie		93 (2x)
Total		93 (2x)

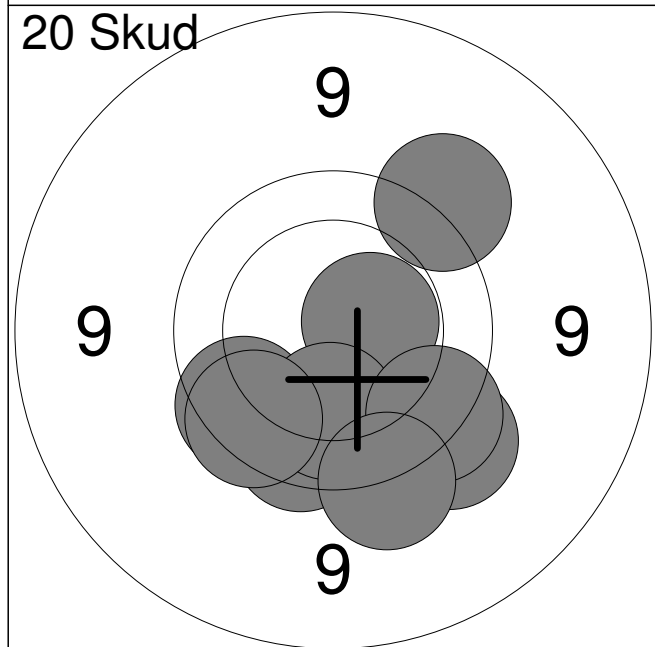

11:	9.7	↘
12:	10.5x	→
13:	9.8	↘
14:	9.5	↘
15:	9.8	↘
16:	10.1	↘
17:	9.5	↗
18:	9.7	↘
19:	9.8	↘
20:	9.5	↘
Serie		92 (1x)
Total		185 (3x)

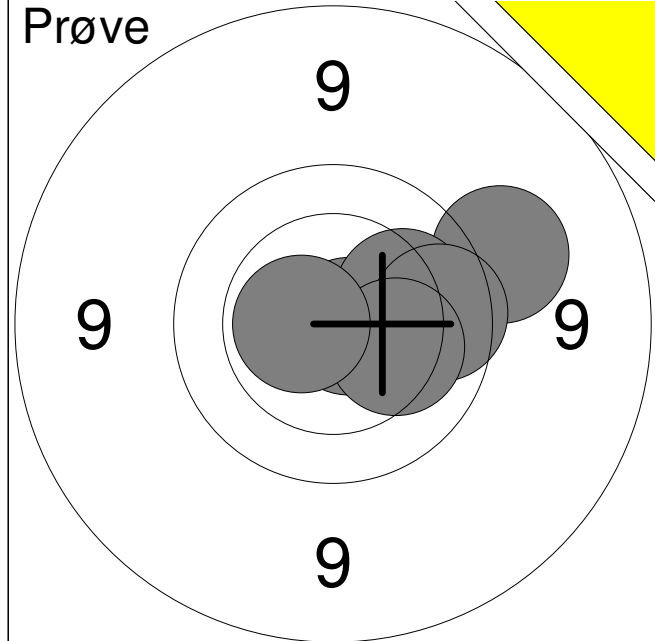

1:	10.8x	→
2:	9.4	→
3:	10.1	→
4:	9.8	→
5:	10.2	→
6:	10.6x	←
Serie		58 (2x)
Total		0 (0x)

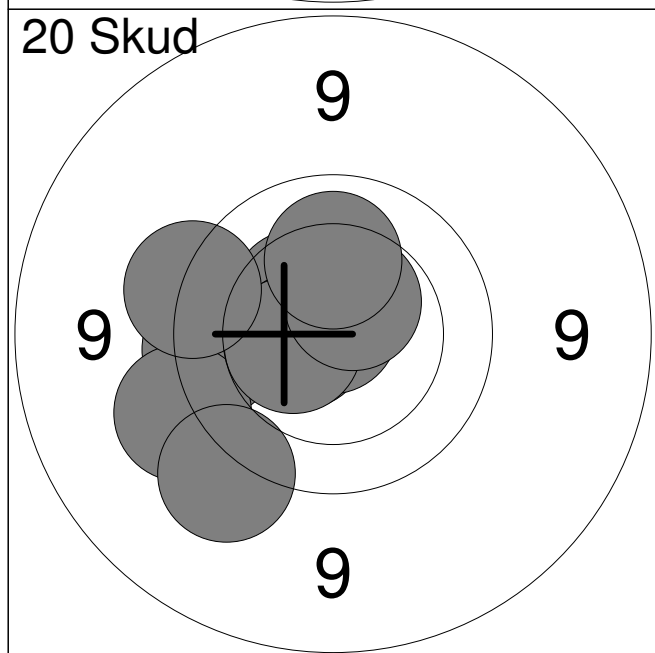

1:	10.4	↖
2:	9.7	←
3:	10.6x	←
4:	9.5	←
5:	9.4	↙
6:	10.8x	↑
7:	10.5	←
8:	9.6	←
9:	10.5x	↗
10:	10.1	↑
Serie		96 (3x)
Total		96 (3x)

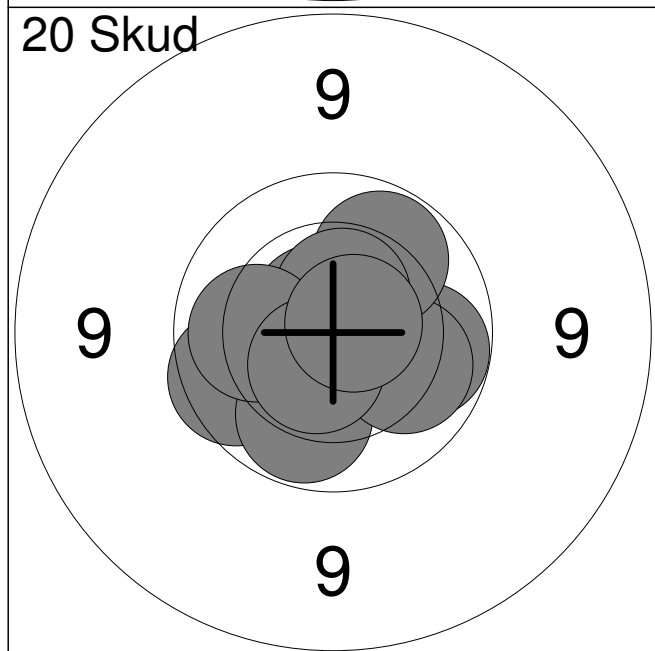

11:	10.7x	↖
12:	9.8	←
13:	10.0	→
14:	10.0	↙
15:	10.1	→
16:	10.0	↗
17:	10.5x	↑
18:	10.1	←
19:	10.5x	↙
20:	10.7x	→
Serie		99 (4x)
Total		195 (7x)

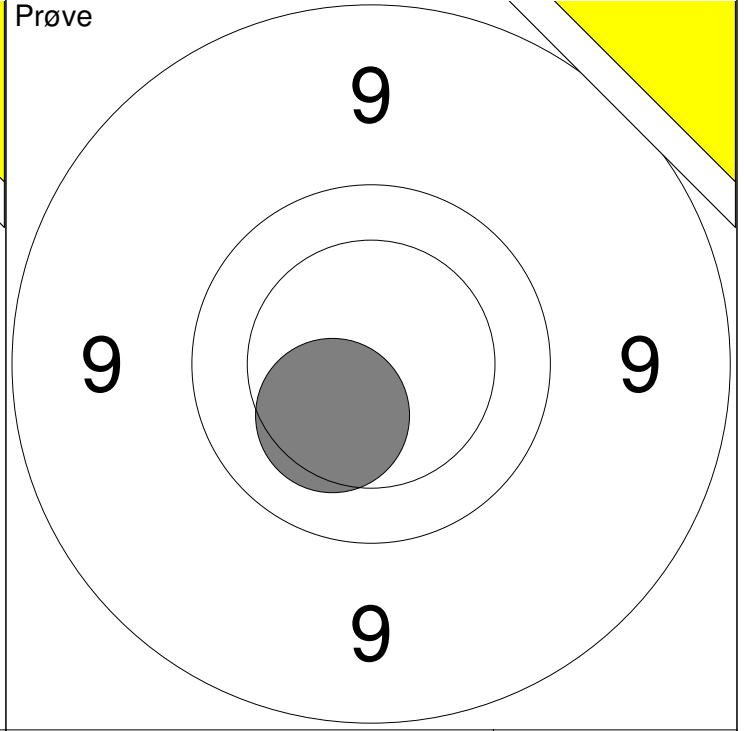
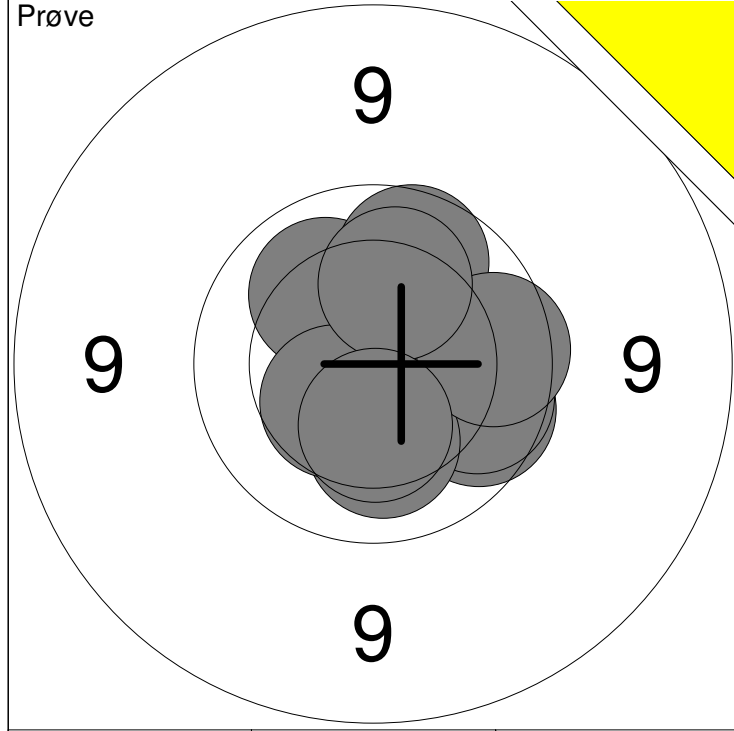

1: 9.9 →	7: 10.4 ↙	Serie	86 (0x)
2: 9.9 →	8: 9.8 →		
3: 10.1 ↗	9: 10.1 ↑	Total	0 (0x)
4: 9.9 ↗	10: 10.4 ↓		
6: 10.2 ↓			

11: 10.3 ↙	Serie	10 (0x)
	Total	0 (0x)

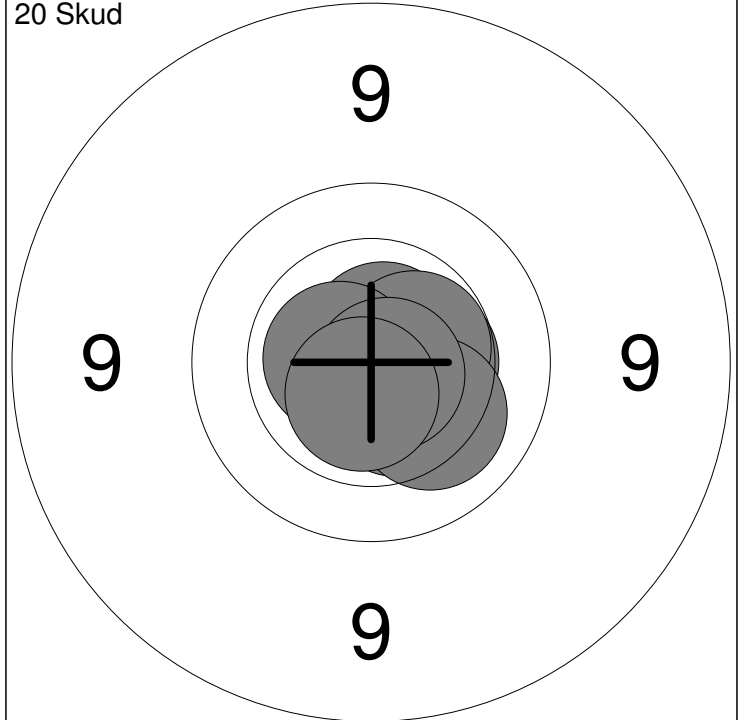
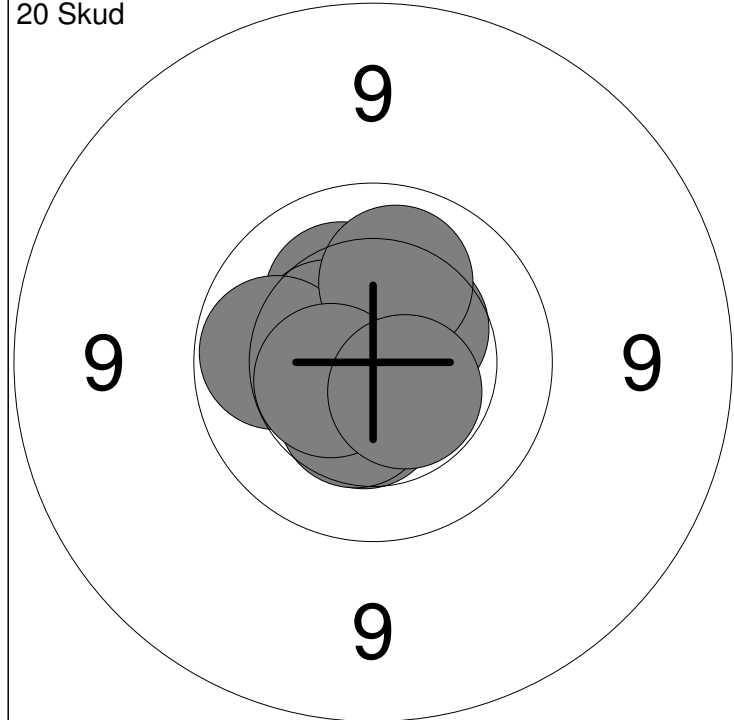

1: 10.3 ↗	6: 10.6x ←	Serie	100 (3x)
2: 10.5 ↗	7: 10.0 ←		
3: 10.5 ↓	8: 10.1 ↑	Total	100 (3x)
4: 10.4 ↗	9: 10.5x ←		
5: 10.4 ↓	10: 10.5x ↘		

11: 10.4 →	16: 10.5x ↗	Serie	100 (8x)
12: 10.8x →	17: 10.6x ←		
13: 10.7x →	18: 10.2 ↘	Total	200 (11x)
14: 10.5x ↘	19: 10.7x ↘		
15: 10.7x ↑	20: 10.6x ↓		

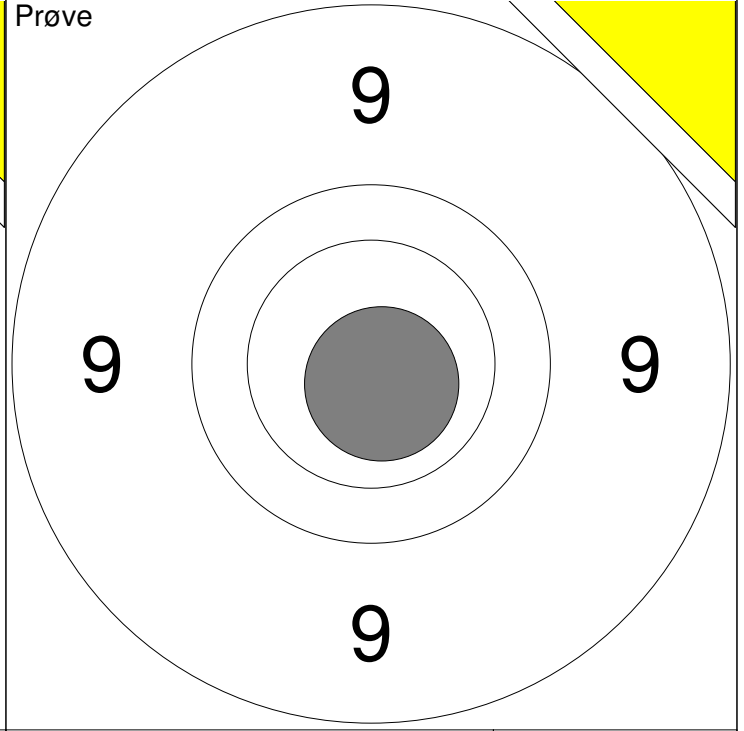
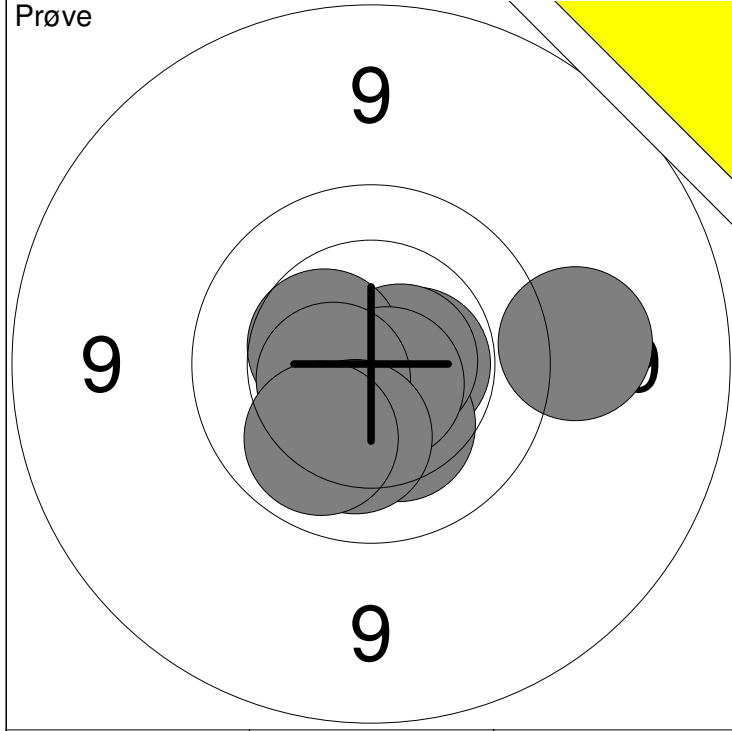

1: 9.4 →	6: 10.5 ←	Serie	99 (5x)
2: 10.5x →	7: 10.7x ↘		
3: 10.3 ↘	8: 10.6x ←	Total	0 (0x)
4: 10.6x ↘	9: 10.2 ↘		
5: 10.7x →	10: 10.1 ↘		

11: 10.7x ↘	Serie	10 (1x)
	Total	0 (0x)

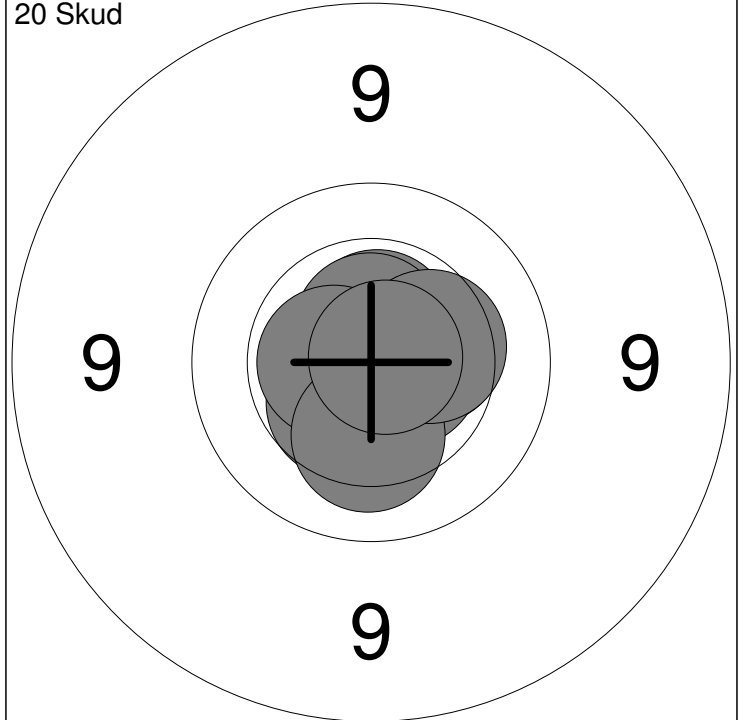
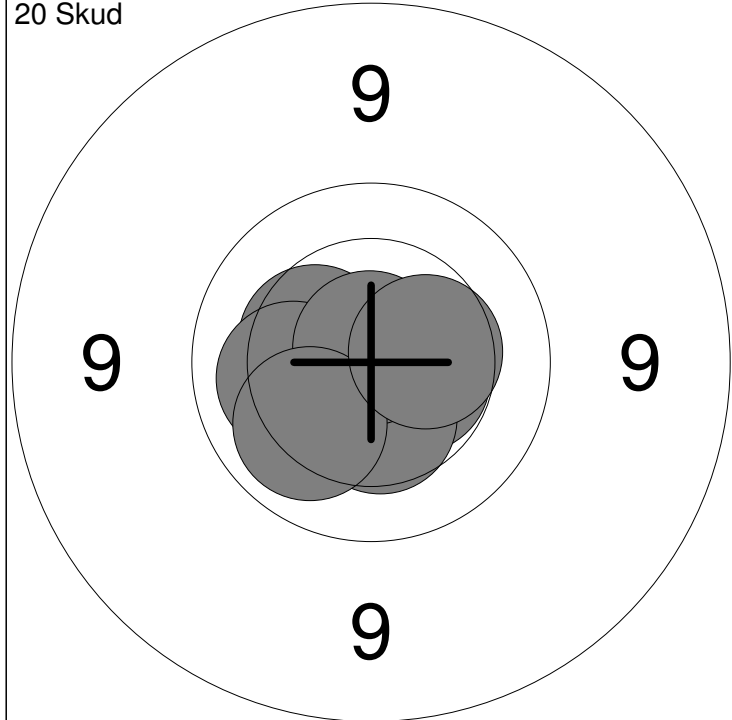

1: 10.4 ←	6: 10.4 ↘	Serie	100 (4x)
2: 10.5 ↘	7: 10.2 ←		
3: 10.7x ↘	8: 10.8x ↑	Total	100 (4x)
4: 10.7x ↘	9: 10.1 ↘		
5: 10.5x →	10: 10.4 →		

11: 10.6x ↑	16: 10.4 →	Serie	100 (6x)
12: 10.5 ↘	17: 10.6x →		
13: 10.6x ↑	18: 10.2 ↘	Total	200 (10x)
14: 10.8x →	19: 10.4 →		
15: 10.6x ←	20: 10.8x →		

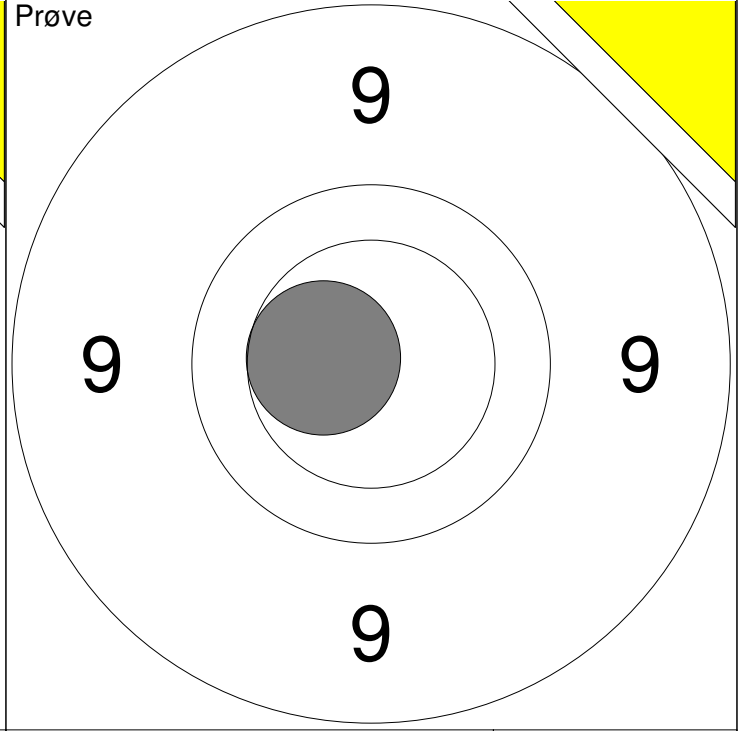
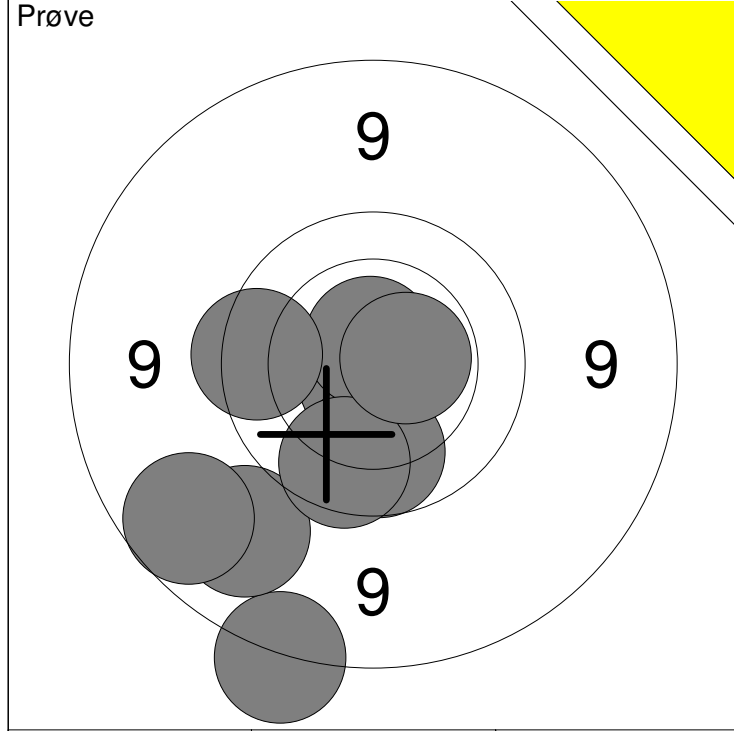

1: 8.7 ↓	6: 9.9 ↓	Serie 92 (3x)
2: 10.7x ↙	7: 10.7x ↑	
3: 9.1 ↙	8: 9.8 ↓	Total 0 (0x)
4: 8.9 ↙	9: 10.6x →	
5: 10.0 ↓	10: 9.8 ←	

11: 10.5 ←	Serie 10 (0x)
	Total 0 (0x)

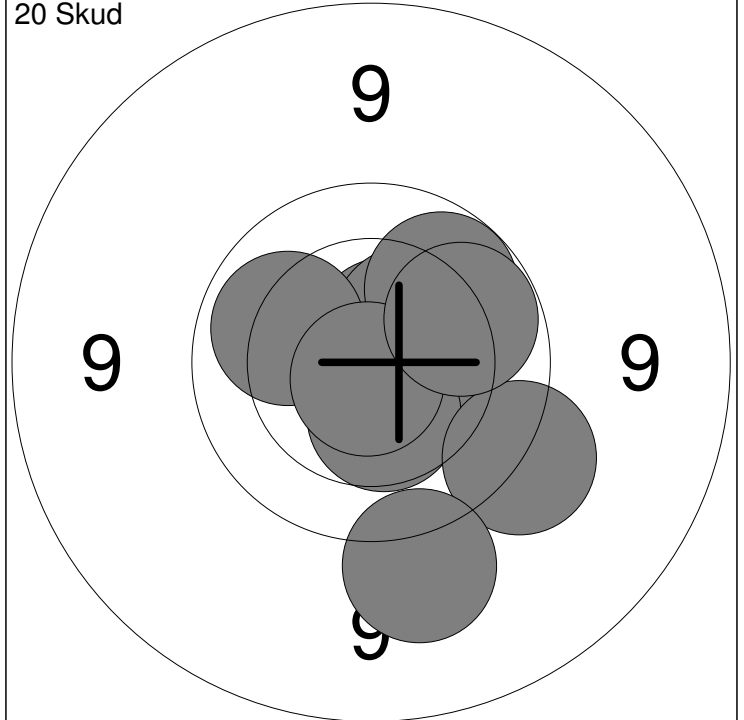
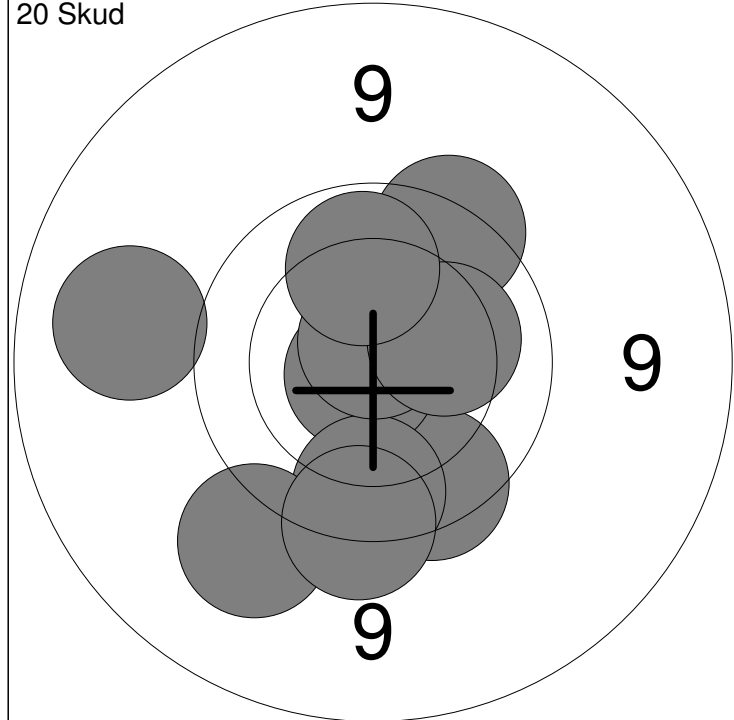

1: 9.7 ↗	6: 9.1 ←	Serie 94 (2x)
2: 9.8 ↓	7: 9.6 ↓	
3: 10.8x ↙	8: 10.7x ↑	Total 94 (2x)
4: 9.8 ↓	9: 10.2 →	
5: 9.3 ↙	10: 10.0 ↑	

11: 10.6x ↗	16: 10.1 ←	Serie 98 (2x)
12: 10.4 →	17: 9.5 ↘	
13: 10.4 ↗	18: 9.4 ↓	Total 192 (4x)
14: 10.0 ↗	19: 10.8x ↓	
15: 10.4 ↓	20: 10.0 →	

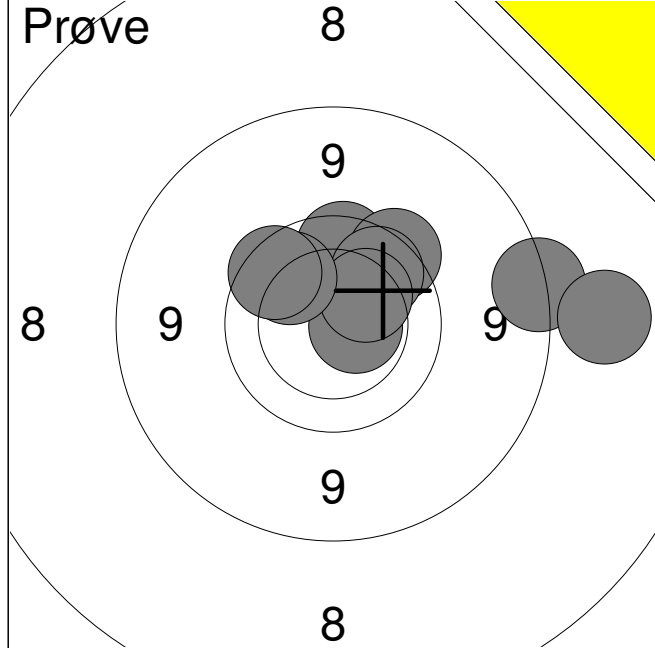

1:	8.7	→
2:	9.9	↗
3:	10.6x	→
4:	9.8	↑
5:	9.7	↗
6:	9.9	↗
7:	10.3	↗
8:	8.3	→
9:	9.9	↗
10:	9.8	↗
Serie		90 (1x)
Total		0 (0x)

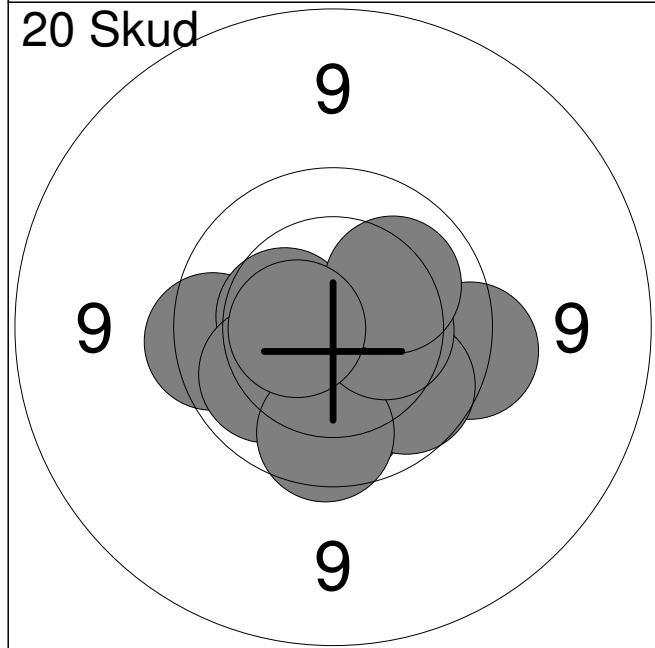

1:	9.6	→
2:	10.0	↓
3:	9.9	↘
4:	9.8	←
5:	10.4	←
6:	10.1	↙
7:	9.9	↓
8:	10.4	→
9:	10.1	↗
10:	10.6x	←
Serie		96 (1x)
Total		96 (1x)

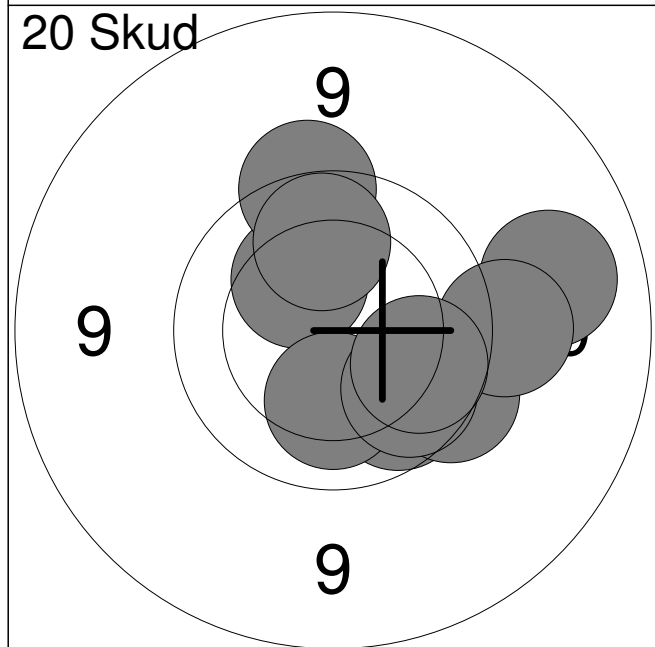

11:	9.9	↘
12:	9.1	→
13:	10.3	↗
14:	9.6	↑
15:	10.2	↓
16:	9.7	↘
17:	9.4	→
18:	9.9	↘
19:	10.0	↑
20:	9.9	↘
Serie		93 (0x)
Total		189 (1x)

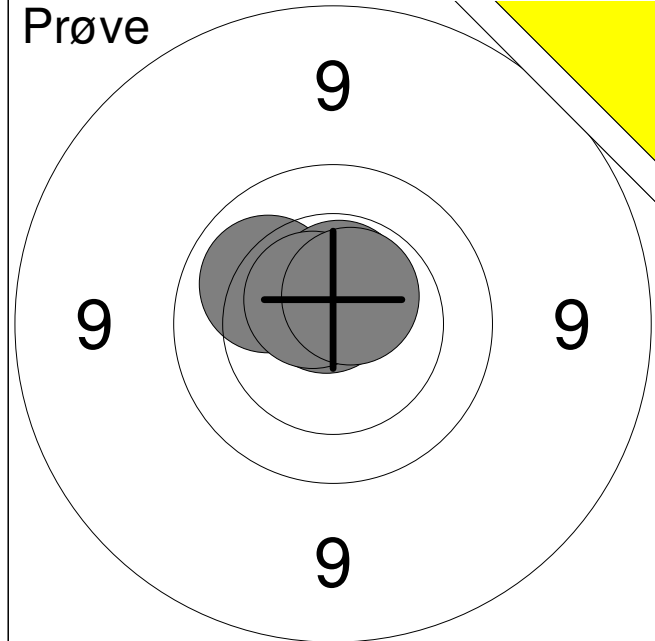

1:	10.1	↖
2:	10.7x	↑
3:	10.6x	↑
4:	10.6x	↖
5:	10.6x	↗
Serie		50 (4x)
Total		0 (0x)

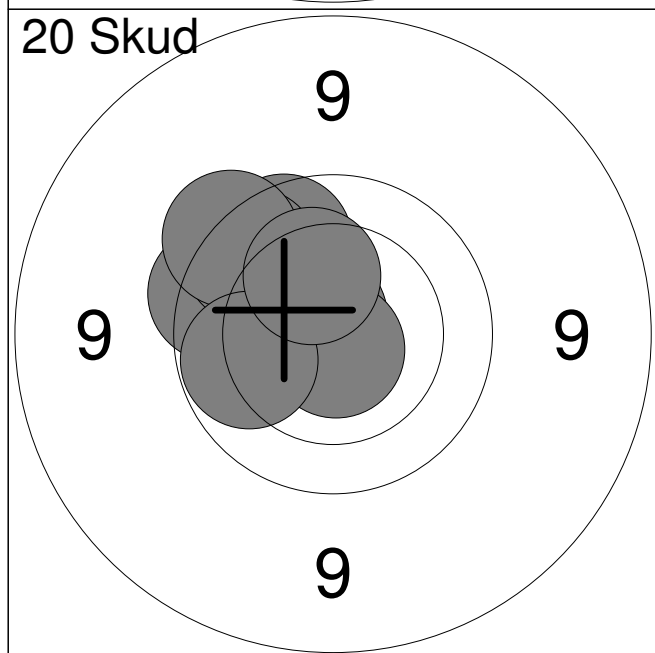

1:	9.9	↗
2:	9.7	↖
3:	10.7x	↗
4:	9.8	↗
5:	10.5x	↖
6:	10.3	↗
7:	10.8x	↓
8:	9.6	↗
9:	10.0	↖
10:	10.3	↑
Serie		96 (3x)
Total		96 (3x)

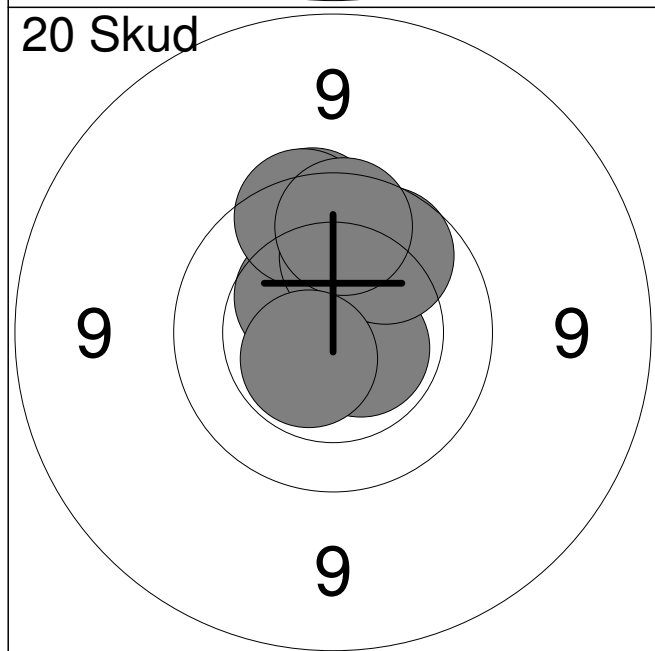

11:	10.5x	↗
12:	10.4	↗
13:	10.8x	↓
14:	10.6x	↓
15:	9.8	↑
16:	9.8	↑
17:	10.1	↑
18:	9.9	↗
19:	9.8	↑
20:	10.6x	↘
Serie		96 (4x)
Total		192 (7x)

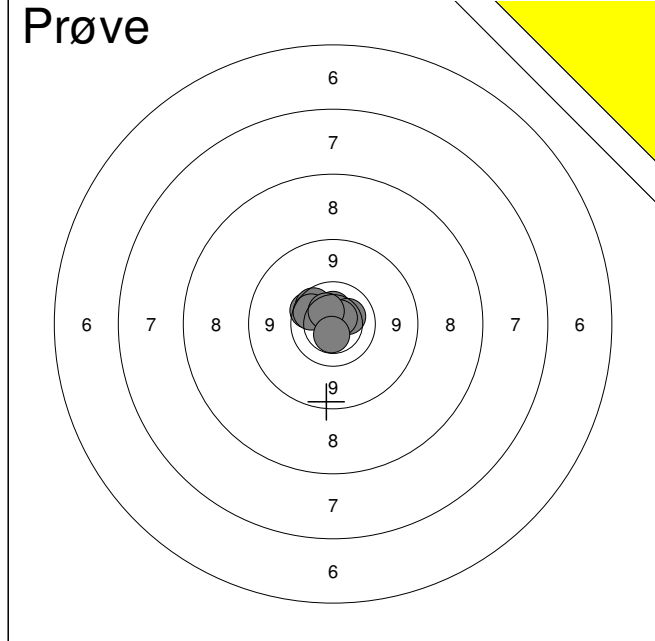

1:	9.8	↖
2:	9.9	↖
3:	10.4	↑
4:	10.3	↗
5:	9.9	↖
6:	10.6x	↗
7:	10.3	↖
8:	0.0	↓
9:	10.5x	↓
Serie		77 (2x)
Total		0 (0x)

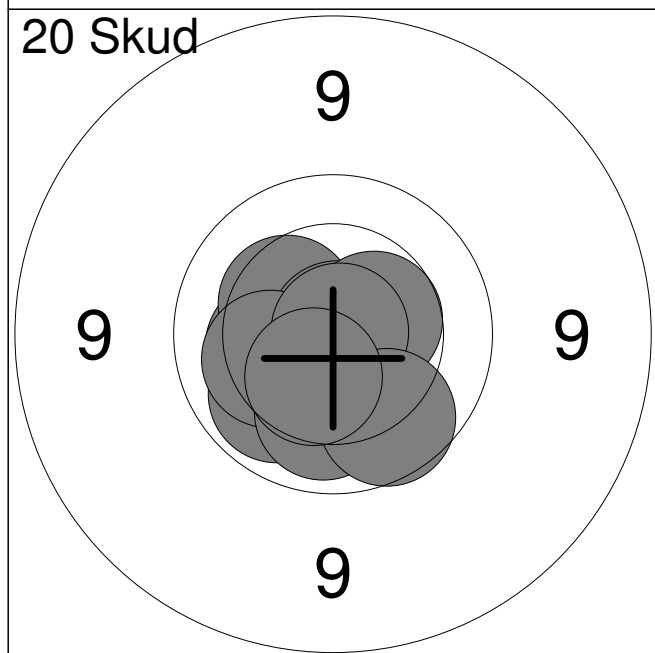

1:	10.0	↙
2:	10.3	←
3:	10.3	↖
4:	10.9x	↗
5:	10.5	↗
6:	10.2	←
7:	10.1	↓
8:	10.9x	↗
9:	9.9	↘
10:	10.4	↘
Serie		99 (2x)
Total		99 (2x)

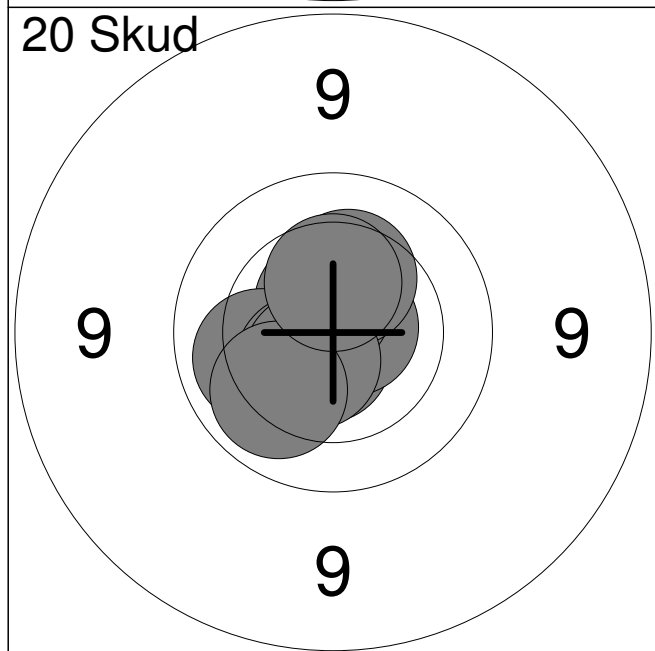

11:	10.7x	↘
12:	10.9x	←
13:	10.8x	↗
14:	10.6x	↑
15:	10.1	←
16:	10.5x	↙
17:	10.3	↑
18:	10.6x	↙
19:	10.1	↙
20:	10.4	↑
Serie		100 (6x)
Total		199 (8x)

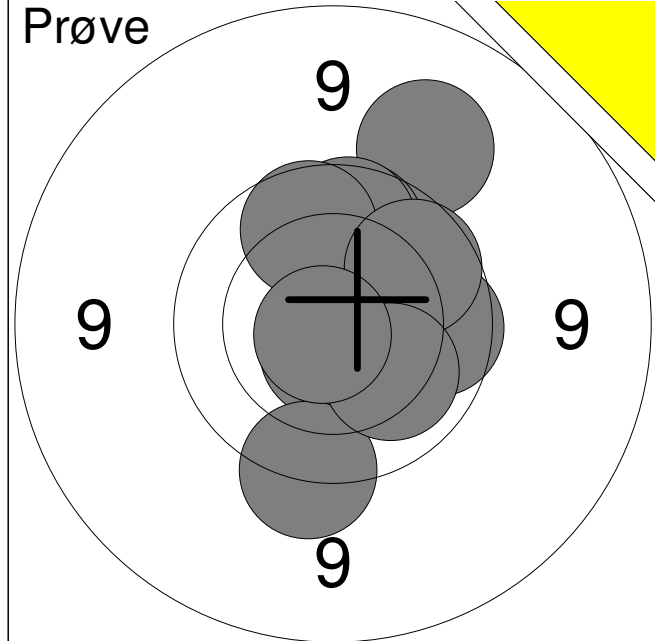

1:	9.9	→
2:	9.3	↗
3:	9.9	↗
4:	9.9	↗
5:	9.9	↗
6:	9.9	↗
7:	10.7x	↓
8:	9.6	↓
9:	10.1	↘
10:	10.8x	↙
Serie		93 (2x)
Total		0 (0x)

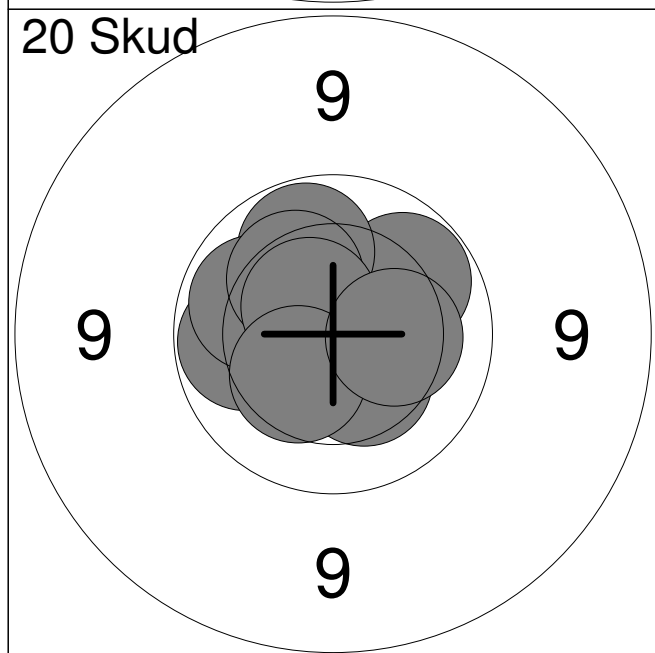

1:	10.0	↗
2:	10.2	↖
3:	10.0	←
4:	10.0	↗
5:	10.1	↖
6:	10.2	↗
7:	10.4	↓
8:	10.5x	↗
9:	10.4	↘
10:	10.3	→
Serie		100 (1x)
Total		100 (1x)

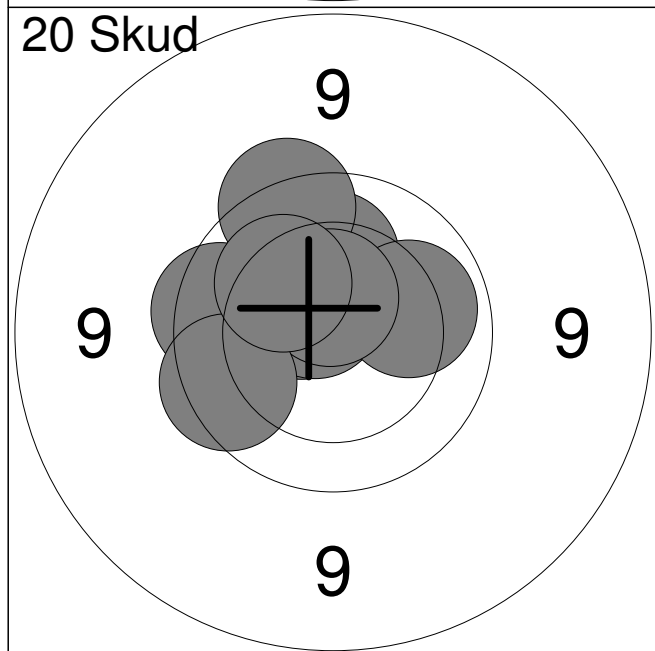

11:	9.8	←
12:	10.5x	↗
13:	10.1	↗
14:	9.7	↗
15:	10.5x	↗
16:	10.6x	↗
17:	10.1	→
18:	10.6x	↗
19:	9.8	↖
20:	10.2	↙
Serie		97 (4x)
Total		197 (5x)

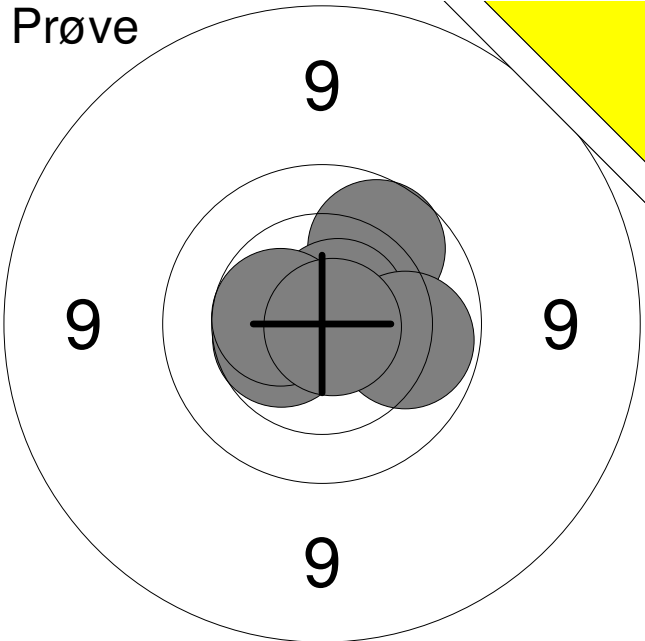
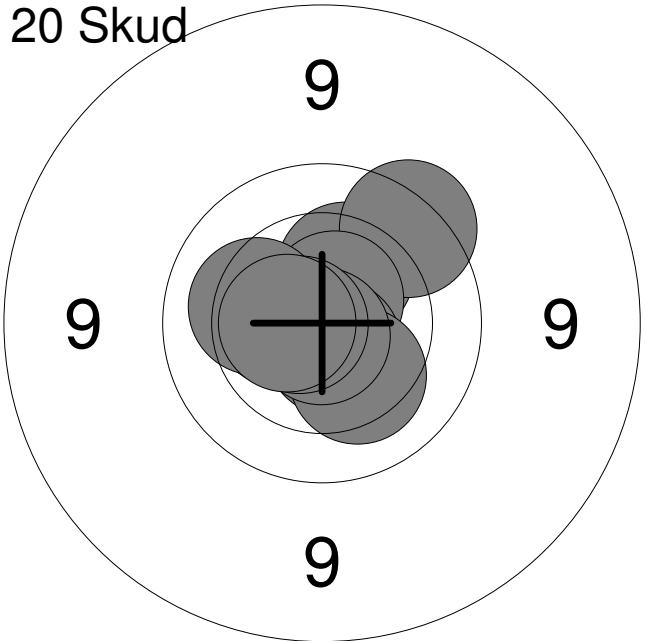
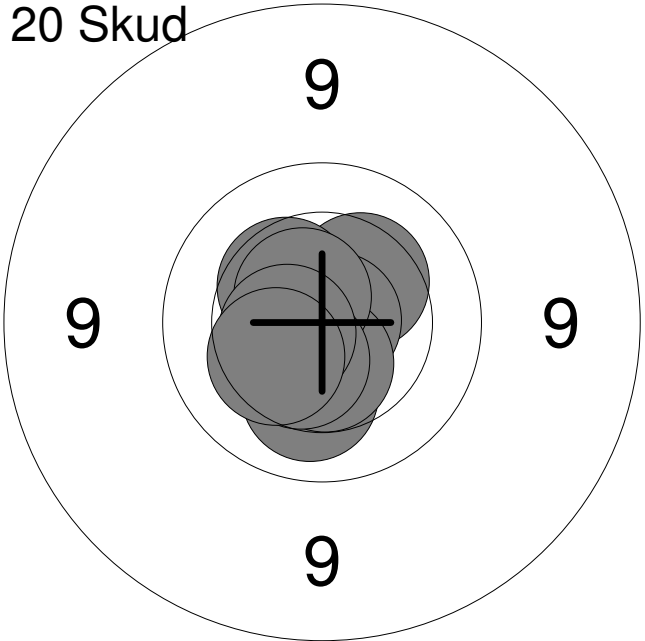
Hold 30	Skive 9	Mikkel_Bisgaard	
15 meter		Hobro Egnens Skytteforening	J1
		Nordjysk mesterskab 2019	Aalborg Skyttekreds
Prøve		1: 9.9 ↗	
		2: 10.5 ←	
		3: 10.7x ↗	
		4: 10.0 →	
		5: 10.5 ←	
		6: 10.8x →	
		Serie	59 (2x)
		Total	0 (0x)
20 Skud		1: 10.5 ←	
		2: 10.3 ↗	
		3: 9.7 ↗	
		4: 10.7x ↗	
		5: 10.7x ↓	
		6: 10.3 ↓	
		7: 10.2 ←	
		8: 10.8x ↓	
		9: 10.7x ←	
		10: 10.6x ←	
		Serie	99 (5x)
		Total	99 (5x)
20 Skud		11: 10.2 ↓	
		12: 10.7x ↓	
		13: 10.3 ↗	
		14: 10.8x →	
		15: 10.5x ↓	
		16: 10.4 ↗	
		17: 10.6x ↗	
		18: 10.5 ↓	
		19: 10.5x ←	
		20: 10.3 ↙	
		Serie	100 (5x)
		Total	199 (10x)

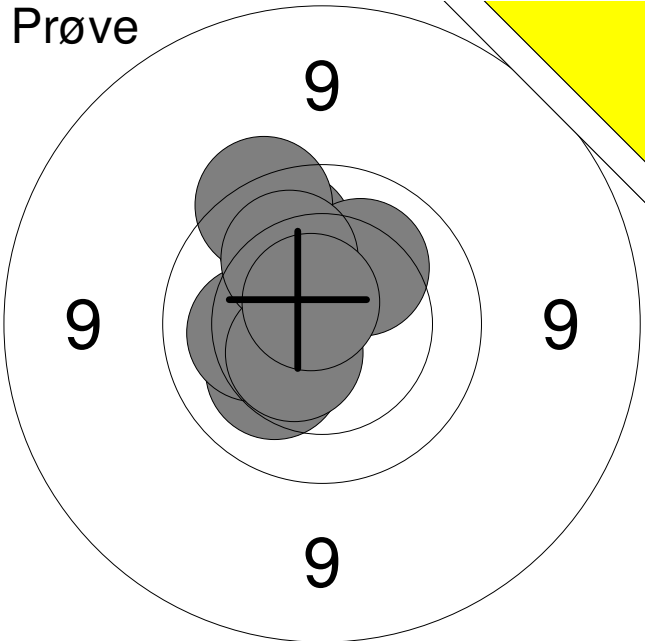
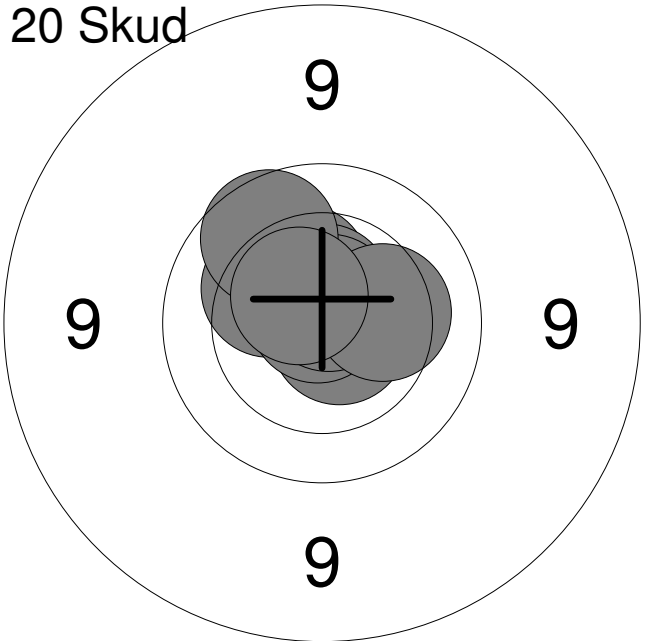
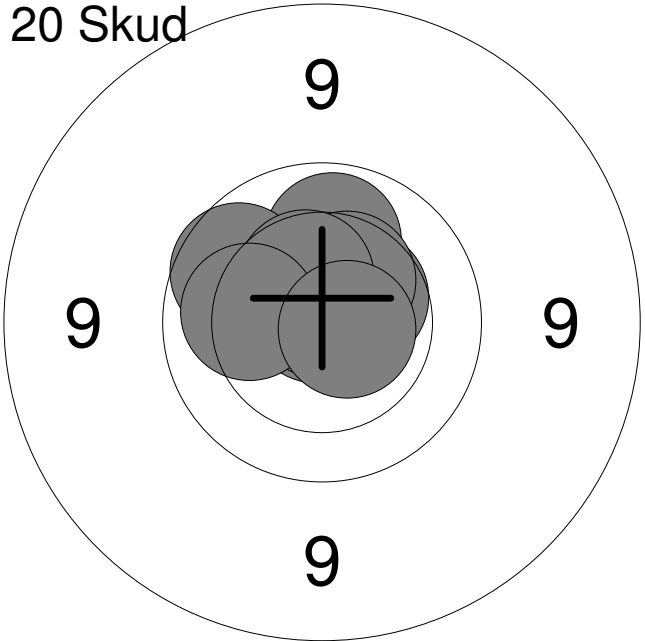
Hold 30	Skive 10	Jeppe Okholm		
15 meter		Hobro Egnens Skytteforening		J1
		Nordjysk mesterskab 2019	Aalborg Skyttekreds	
Prøve		1:	9.9	↗
		2:	10.2	↘
		3:	10.5x	←
		4:	9.7	↗
5:	10.2	←		
6:	10.2	↗		
7:	10.1	↗		
8:	10.5x	↘		
9:	10.7x	↗		
		Serie	88 (3x)	
		Total	0 (0x)	
20 Skud		1:	10.3	↗
		2:	10.7x	→
		3:	10.3	↗
		4:	10.6x	↑
5:	10.7x	↘		
6:	10.8x	↗		
7:	10.7x	↗		
8:	9.9	↗		
9:	10.3	→		
10:	10.6x	↗		
		Serie	99 (6x)	
		Total	99 (6x)	
20 Skud		11:	10.5	↗
		12:	10.8x	↗
		13:	10.8x	↑
		14:	10.0	↑
15:	10.5x	↗		
16:	9.9	↘		
17:	10.4	↗		
18:	10.4	↗		
19:	10.1	←		
20:	10.7x	→		
		Serie	99 (4x)	
		Total	198 (10x)	

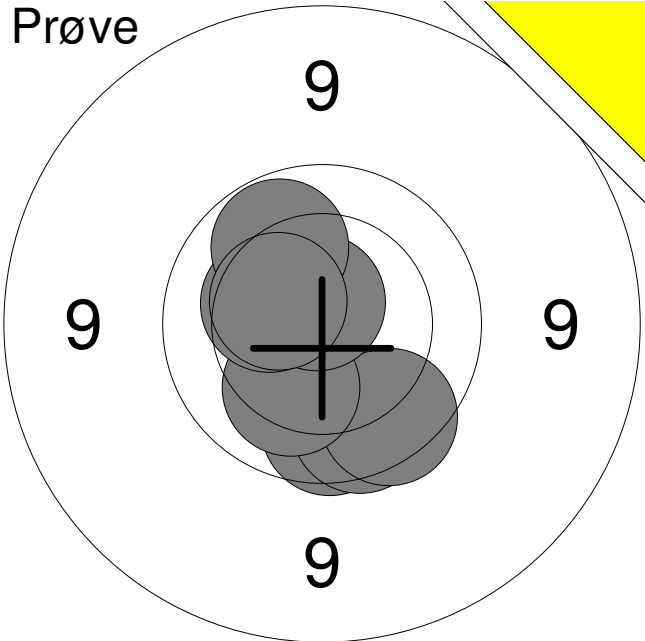
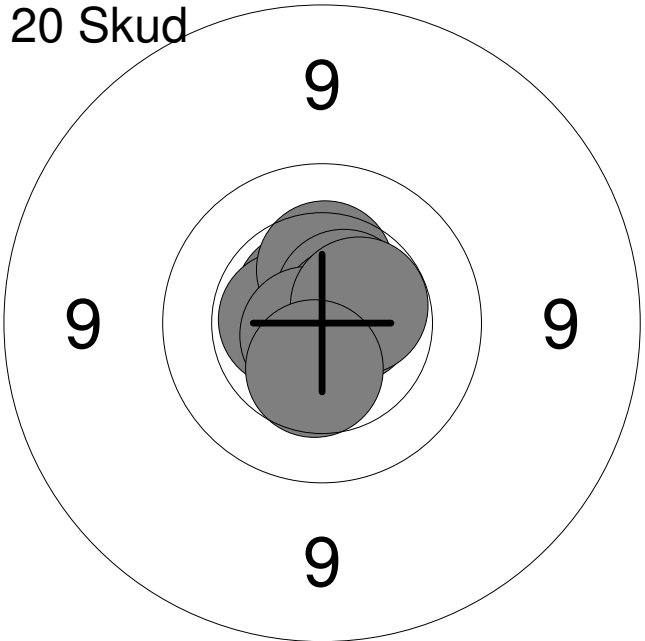
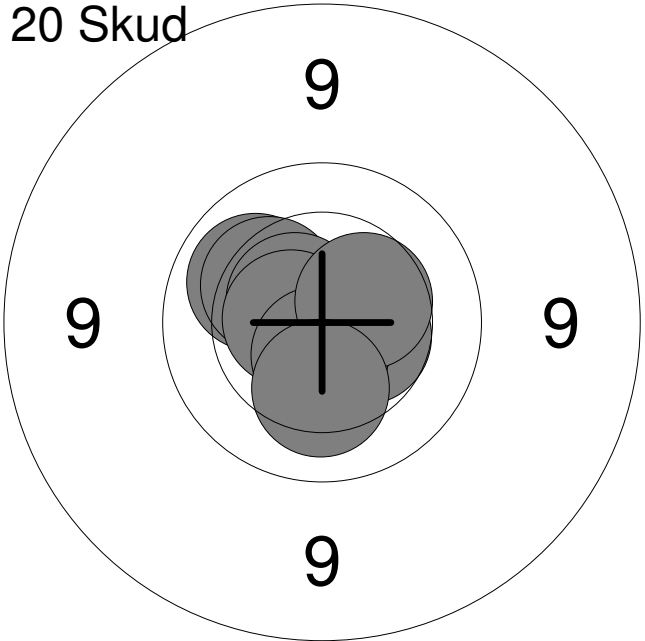
Hold 30	Skive 11	Mathias L. Mikkelsen		
15 meter		Hobro Egnens Skytteforening		BK1
		Nordjysk mesterskab 2019	Aalborg Skyttekreds	
Prøve		1:	9.9	↓
		2:	9.8	↓
		3:	9.8	↓
		4:	10.2	↓
		5:	10.3	↖
		6:	10.7x	↑
		7:	10.0	↗
		8:	10.4	↖
		Serie		77 (1x)
		Total		0 (0x)
20 Skud		1:	10.7x	↙
		2:	10.8x	↗
		3:	10.6x	↗
		4:	10.6x	←
		5:	10.4	↑
		6:	10.6x	↗
		7:	10.6x	→
		8:	10.8x	↙
		9:	10.5x	→
		10:	10.4	↓
		Serie		100 (8x)
		Total		100 (8x)
20 Skud		11:	10.7x	↖
		12:	10.1	↗
		13:	10.2	↗
		14:	10.6x	↗
		15:	10.7x	↙
		16:	10.6x	←
		17:	10.5	→
		18:	10.6x	↓
		19:	10.4	↗
		20:	10.2	↓
		Serie		100 (5x)
		Total		200 (13x)

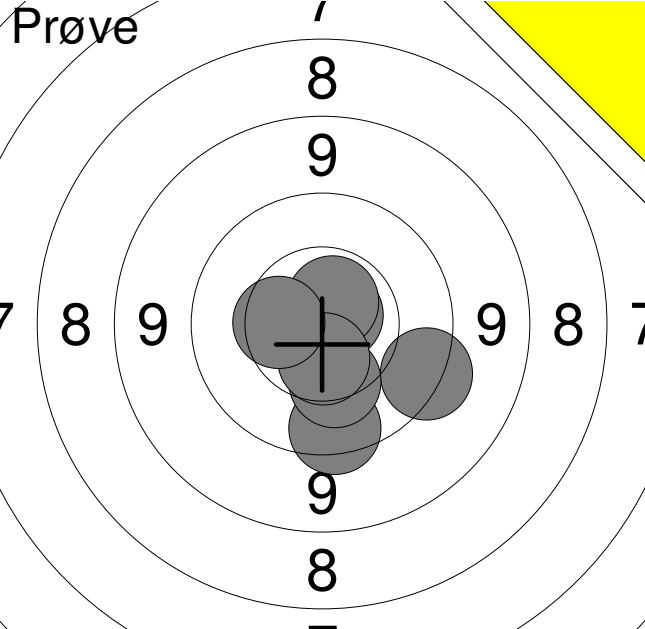
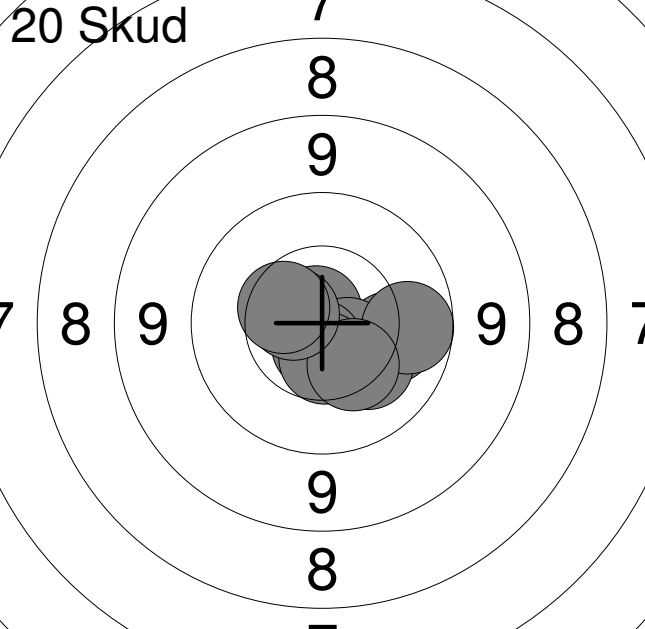
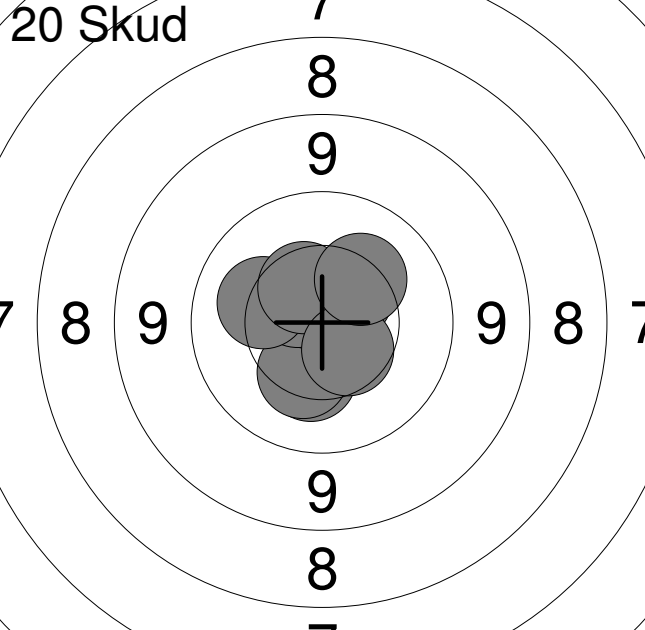
Hold 30	Skive 12	Esajas_Hvorvarp	
15 meter		Vilsted Skytteforening	J2
		Nordjysk mesterskab 2019	Aalborg Skyttekreds
Prøve 	1:	9.6	→
	2:	9.7	↓
	3:	10.3	↓
	4:	10.7x	↗
	5:	10.7x	↗
	6:	10.5	↓
	7:	10.4	←
	Serie		68 (2x)
Total		0 (0x)	
20 Skud 	1:	10.1	→
	2:	10.8x	↗
	3:	10.2	↓
	4:	10.6	↓
	5:	10.7x	↓
	6:	10.5	↓
	7:	9.9	→
	8:	10.3	↓
	9:	10.6x	←
	10:	10.5	←
Serie		99 (3x)	
Total		99 (3x)	
20 Skud 	11:	10.3	↓
	12:	10.6	↑
	13:	10.3	↓
	14:	10.5	↗
	15:	10.7x	↗
	16:	10.6	↗
	17:	10.2	←
	18:	10.5	↗
	19:	10.5	↓
	20:	10.3	↗
Serie		100 (1x)	
Total		199 (4x)	

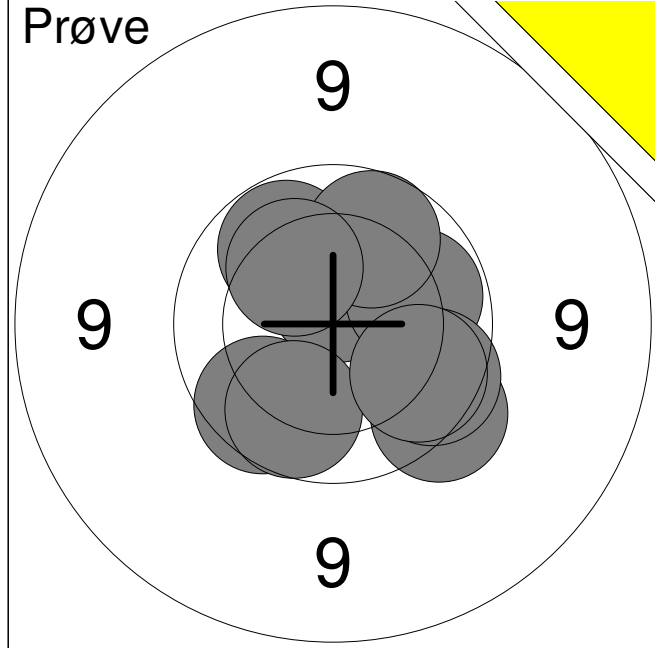

1:	10.6x	↑
2:	10.0	↗
3:	9.8	↘
4:	10.0	→
5:	9.7	↘
6:	9.9	↘
7:	9.9	↗
8:	9.8	↘
9:	9.9	↘
10:	10.2	↗
Serie		94 (1x)
Total		0 (0x)

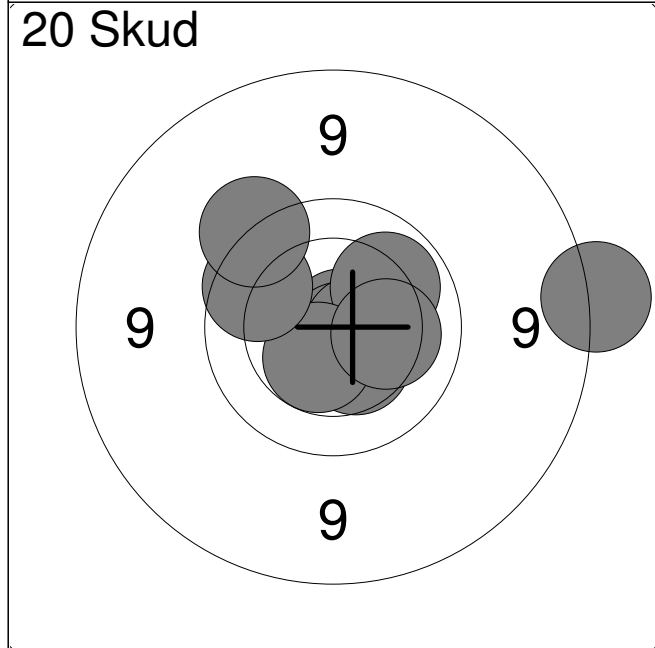

1:	10.8x	→
2:	10.8x	↘
3:	10.6x	→
4:	10.1	↗
5:	10.4	↘
6:	10.5	↘
7:	9.9	↗
8:	10.2	→
9:	8.6	→
10:	9.6	↗
Serie		96 (3x)
Total		96 (3x)

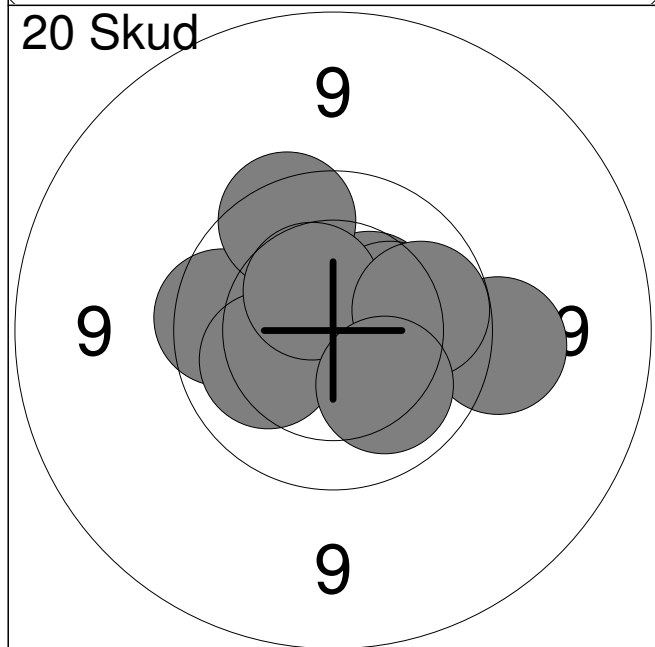

11:	10.4	↗
12:	9.8	←
13:	9.8	↗
14:	10.6x	←
15:	10.2	←
16:	10.3	→
17:	10.5	↗
18:	9.5	→
19:	10.0	→
20:	10.1	↘
Serie		97 (1x)
Total		193 (4x)

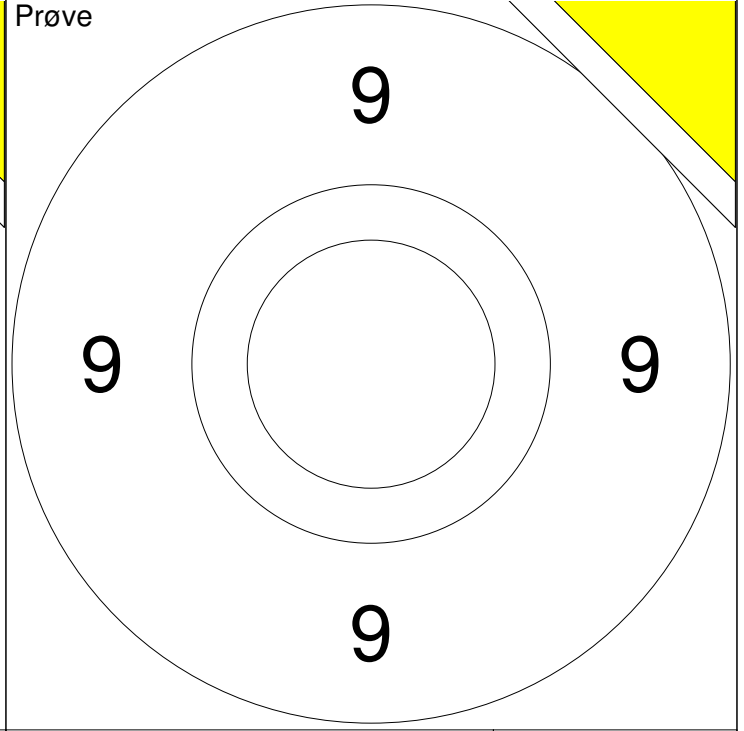
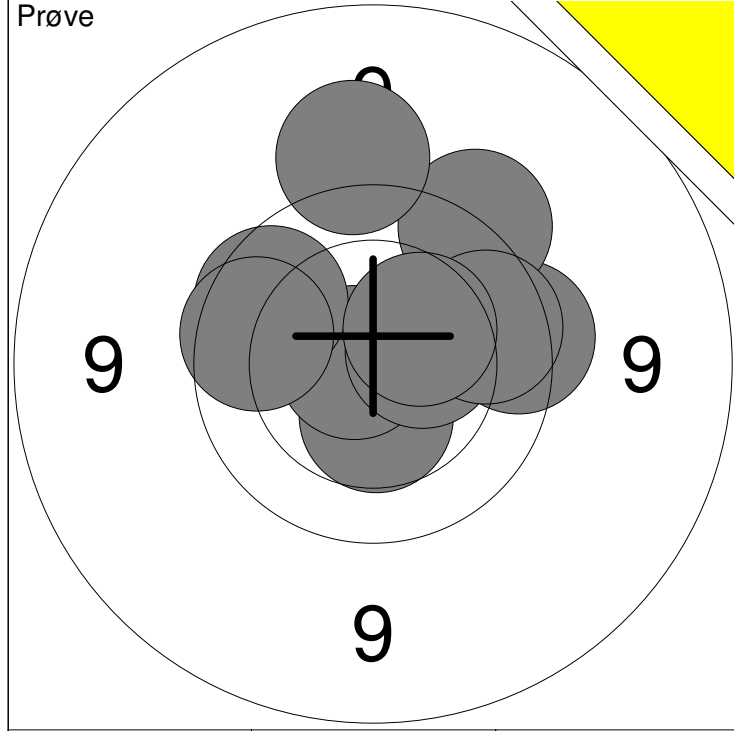

1: 9.7 →	6: 9.8 ←	Serie	94 (1x)
2: 9.6 ↗	7: 10.5 →		
3: 10.4 ↓	8: 9.9 →	Total	0 (0x)
4: 10.8x ←	9: 9.4 ↑		
5: 9.9 ↖	10: 10.4 ↗		

		Serie	0 (0x)
		Total	0 (0x)

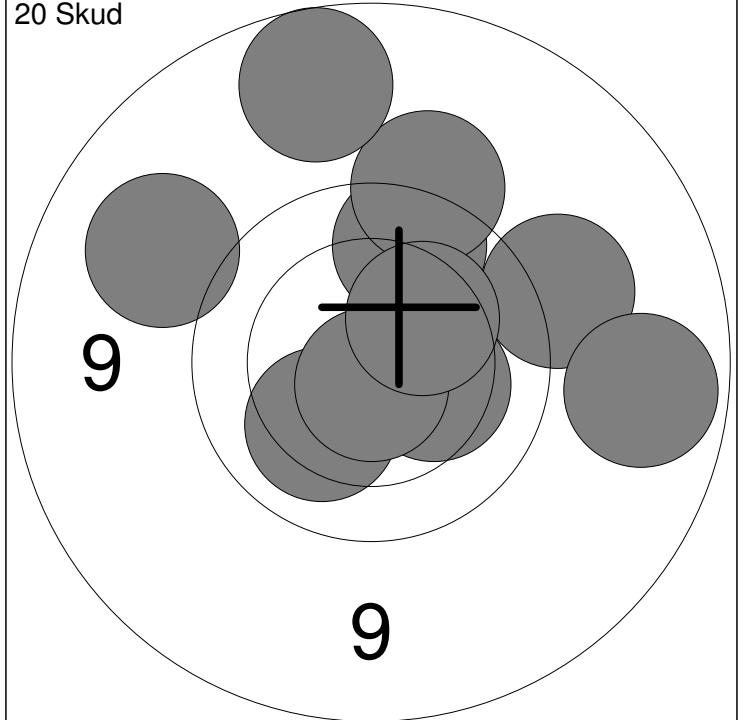
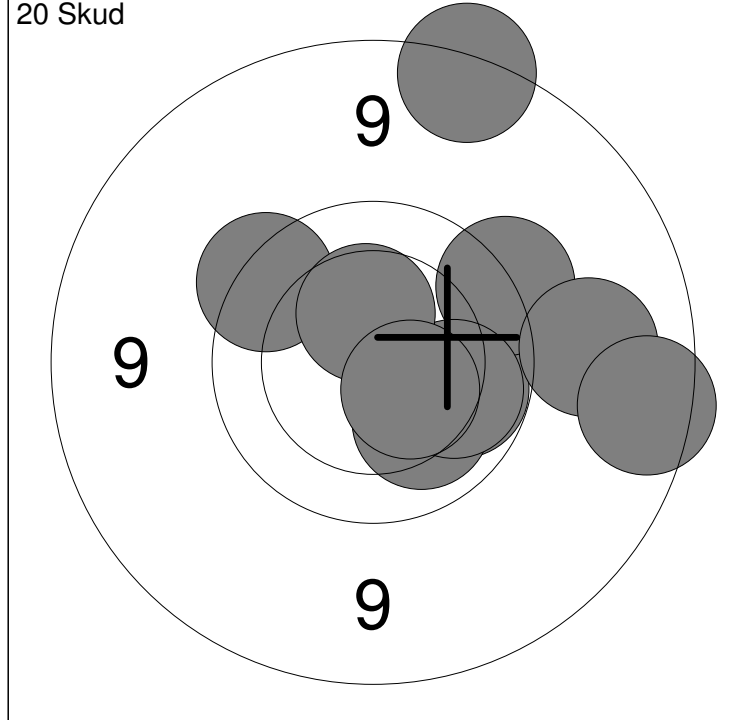

1: 10.0 →	6: 10.0 →	Serie	93 (0x)
2: 9.6 ↗	7: 8.9 →		
3: 9.7 ↗	8: 10.4 ↑	Total	93 (0x)
4: 9.2 →	9: 8.7 ↑		
5: 10.1 ↓	10: 10.4 ↘		

11: 9.4 →	16: 8.9 ↑	Serie	93 (1x)
12: 9.8 ↑	17: 10.3 →		
13: 9.0 →	18: 10.7x ↓	Total	186 (1x)
14: 10.2 ↙	19: 10.3 ↗		
15: 9.5 ↑	20: 9.2 ←		

<p>Prøve</p>	<table style="width:100%; border-collapse: collapse;"> <tr><td style="width:5%;">1:</td><td style="width:15%;">9.4</td><td style="width:10%; text-align: right;">↓</td></tr> <tr><td>2:</td><td>10.6x</td><td style="text-align: right;">→</td></tr> <tr><td>3:</td><td>10.1</td><td style="text-align: right;">↖</td></tr> <tr><td>4:</td><td>9.1</td><td style="text-align: right;">←</td></tr> <tr><td>5:</td><td>10.5x</td><td style="text-align: right;">↑</td></tr> <tr><td>6:</td><td>10.0</td><td style="text-align: right;">↓</td></tr> <tr><td>7:</td><td>9.9</td><td style="text-align: right;">↓</td></tr> <tr><td>8:</td><td>10.1</td><td style="text-align: right;">↑</td></tr> <tr><td>9:</td><td>10.1</td><td style="text-align: right;">←</td></tr> </table> <table border="1" style="width:100%; border-collapse: collapse; margin-top: 5px;"> <tr> <td style="width:80%;">Serie</td> <td style="text-align: right;">87 (2x)</td> </tr> <tr> <td>Total</td> <td style="text-align: right;">0 (0x)</td> </tr> </table>	1:	9.4	↓	2:	10.6x	→	3:	10.1	↖	4:	9.1	←	5:	10.5x	↑	6:	10.0	↓	7:	9.9	↓	8:	10.1	↑	9:	10.1	←	Serie	87 (2x)	Total	0 (0x)
1:	9.4	↓																														
2:	10.6x	→																														
3:	10.1	↖																														
4:	9.1	←																														
5:	10.5x	↑																														
6:	10.0	↓																														
7:	9.9	↓																														
8:	10.1	↑																														
9:	10.1	←																														
Serie	87 (2x)																															
Total	0 (0x)																															

<p>20 Skud</p>	<table style="width:100%; border-collapse: collapse;"> <tr><td style="width:5%;">1:</td><td style="width:15%;">9.8</td><td style="width:10%; text-align: right;">↘</td></tr> <tr><td>2:</td><td>10.8x</td><td style="text-align: right;">→</td></tr> <tr><td>3:</td><td>10.1</td><td style="text-align: right;">→</td></tr> <tr><td>4:</td><td>9.6</td><td style="text-align: right;">↑</td></tr> <tr><td>5:</td><td>10.7x</td><td style="text-align: right;">↓</td></tr> <tr><td>6:</td><td>9.9</td><td style="text-align: right;">↓</td></tr> <tr><td>7:</td><td>10.0</td><td style="text-align: right;">→</td></tr> <tr><td>8:</td><td>9.7</td><td style="text-align: right;">↓</td></tr> <tr><td>9:</td><td>10.0</td><td style="text-align: right;">↓</td></tr> <tr><td>10:</td><td>10.7x</td><td style="text-align: right;">↓</td></tr> </table> <table border="1" style="width:100%; border-collapse: collapse; margin-top: 5px;"> <tr> <td style="width:80%;">Serie</td> <td style="text-align: right;">96 (3x)</td> </tr> <tr> <td>Total</td> <td style="text-align: right;">96 (3x)</td> </tr> </table>	1:	9.8	↘	2:	10.8x	→	3:	10.1	→	4:	9.6	↑	5:	10.7x	↓	6:	9.9	↓	7:	10.0	→	8:	9.7	↓	9:	10.0	↓	10:	10.7x	↓	Serie	96 (3x)	Total	96 (3x)
1:	9.8	↘																																	
2:	10.8x	→																																	
3:	10.1	→																																	
4:	9.6	↑																																	
5:	10.7x	↓																																	
6:	9.9	↓																																	
7:	10.0	→																																	
8:	9.7	↓																																	
9:	10.0	↓																																	
10:	10.7x	↓																																	
Serie	96 (3x)																																		
Total	96 (3x)																																		

<p>20 Skud</p>	<table style="width:100%; border-collapse: collapse;"> <tr><td style="width:5%;">11:</td><td style="width:15%;">9.9</td><td style="width:10%; text-align: right;">↑</td></tr> <tr><td>12:</td><td>9.7</td><td style="text-align: right;">↓</td></tr> <tr><td>13:</td><td>9.9</td><td style="text-align: right;">↓</td></tr> <tr><td>14:</td><td>10.8x</td><td style="text-align: right;">↙</td></tr> <tr><td>15:</td><td>10.4</td><td style="text-align: right;">↓</td></tr> <tr><td>16:</td><td>10.3</td><td style="text-align: right;">→</td></tr> <tr><td>17:</td><td>9.7</td><td style="text-align: right;">↘</td></tr> <tr><td>18:</td><td>10.0</td><td style="text-align: right;">→</td></tr> <tr><td>19:</td><td>9.6</td><td style="text-align: right;">→</td></tr> <tr><td>20:</td><td>9.5</td><td style="text-align: right;">↓</td></tr> </table> <table border="1" style="width:100%; border-collapse: collapse; margin-top: 5px;"> <tr> <td style="width:80%;">Serie</td> <td style="text-align: right;">94 (1x)</td> </tr> <tr> <td>Total</td> <td style="text-align: right;">190 (4x)</td> </tr> </table>	11:	9.9	↑	12:	9.7	↓	13:	9.9	↓	14:	10.8x	↙	15:	10.4	↓	16:	10.3	→	17:	9.7	↘	18:	10.0	→	19:	9.6	→	20:	9.5	↓	Serie	94 (1x)	Total	190 (4x)
11:	9.9	↑																																	
12:	9.7	↓																																	
13:	9.9	↓																																	
14:	10.8x	↙																																	
15:	10.4	↓																																	
16:	10.3	→																																	
17:	9.7	↘																																	
18:	10.0	→																																	
19:	9.6	→																																	
20:	9.5	↓																																	
Serie	94 (1x)																																		
Total	190 (4x)																																		

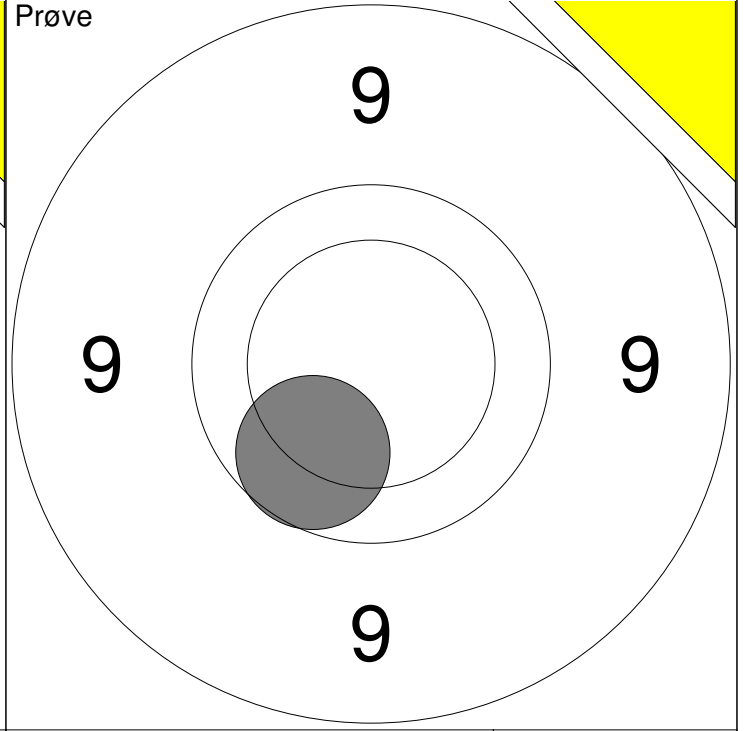
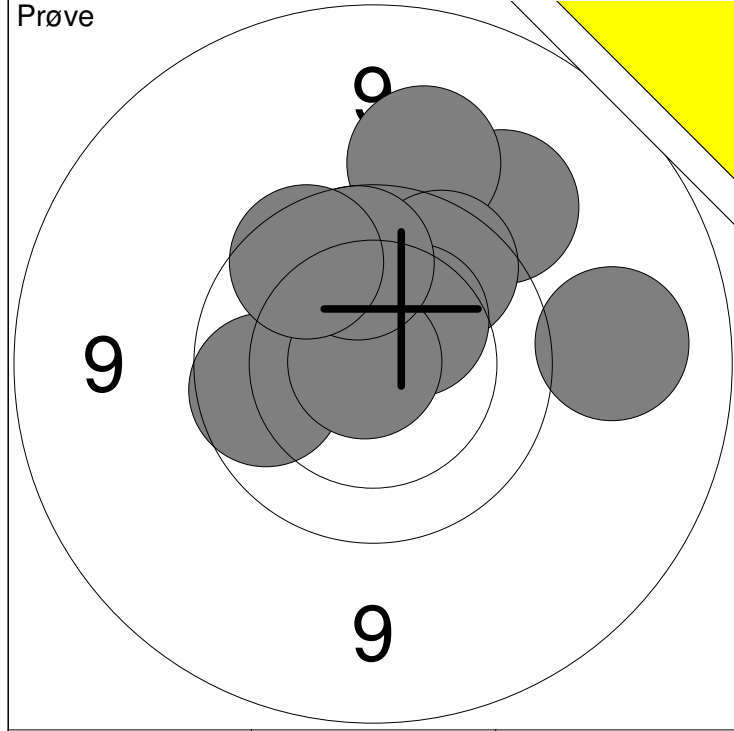

1: 9.2 →	6: 10.4 ↗	Serie	93 (1x)
2: 9.4 ↗	7: 9.9 ←		
3: 9.4 ↑	8: 10.9x ←	Total	0 (0x)
4: 10.3 ↗	9: 9.9 ↑		
5: 9.9 ↗	10: 9.8 ↘		

11: 9.9 ↘	Serie	9 (0x)
	Total	0 (0x)

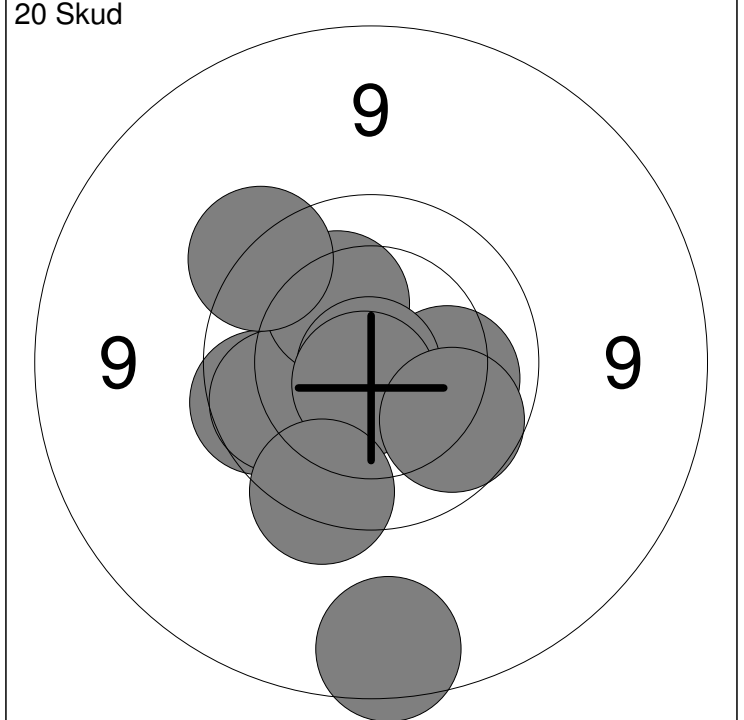
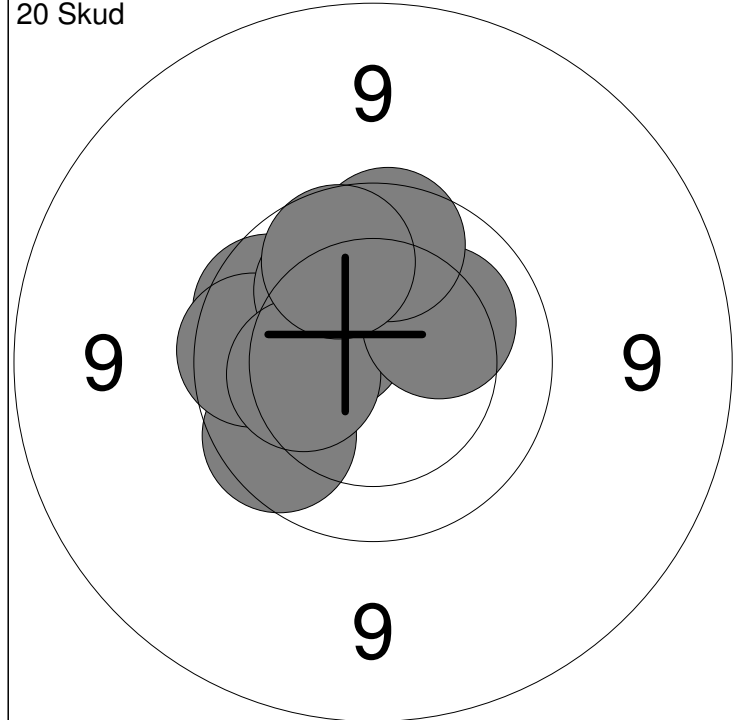

1: 10.5 ↖	6: 10.1 ↖	Serie	95 (0x)
2: 10.2 ↖	7: 10.3 ←		
3: 9.9 ↖	8: 10.2 ↗	Total	95 (0x)
4: 9.9 ↙	9: 9.9 ↑		
5: 9.9 ←	10: 9.9 ↗		

11: 9.8 ←	16: 10.9x ↓	Serie	93 (2x)
12: 9.9 ←	17: 10.7x ↓		
13: 10.2 ↗	18: 9.6 ↖	Total	188 (2x)
14: 8.9 ↓	19: 9.7 ↓		
15: 10.1 →	20: 9.9 ↘		

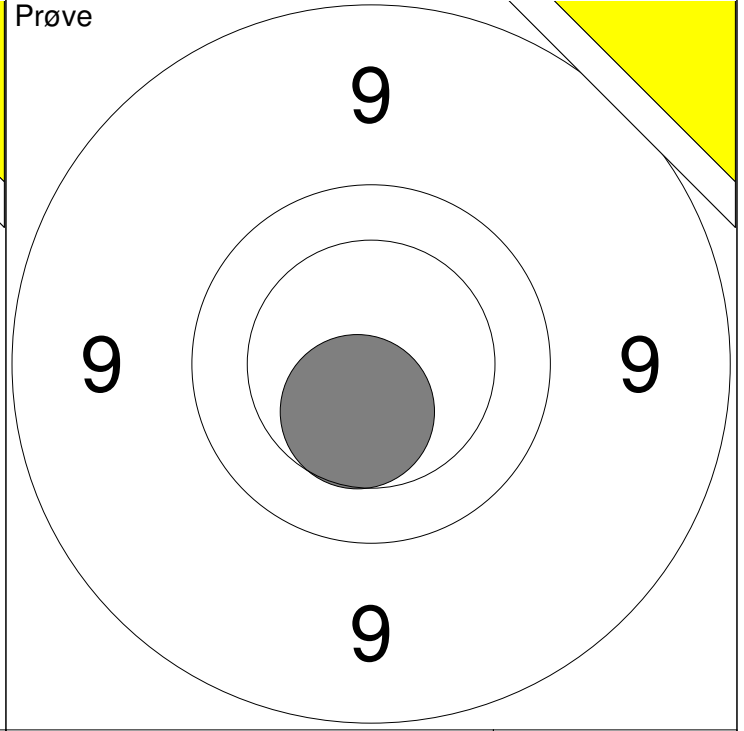
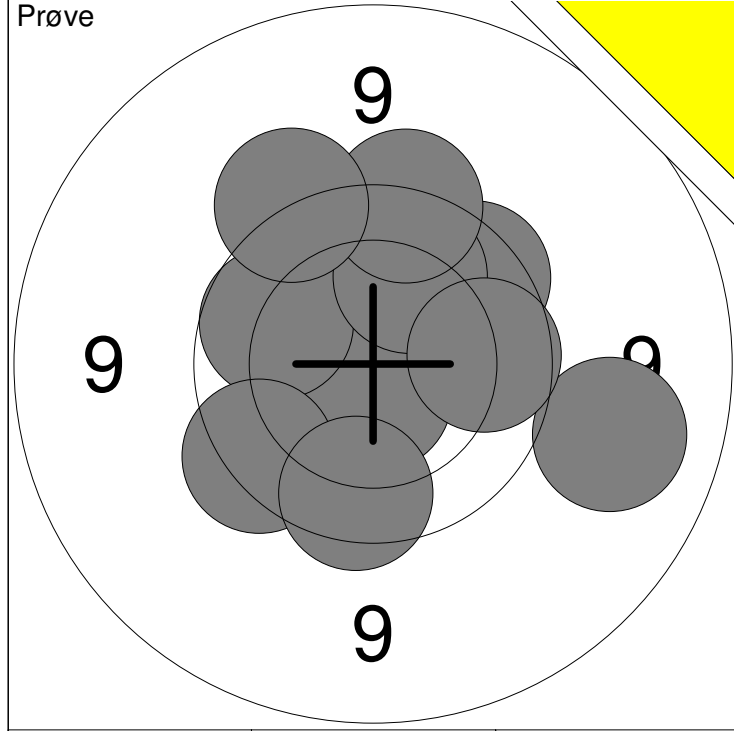

1: 10.6x ↓	6: 10.0 ↗	Serie	92 (1x)
2: 9.9 ↖	7: 9.1 →		
3: 9.7 ↙	8: 9.6 ↗	Total	0 (0x)
4: 9.8 ↓	9: 9.5 ↗		
5: 9.8 ↗	10: 9.9 →		

11: 10.5 ↓	Serie	10 (0x)
	Total	0 (0x)

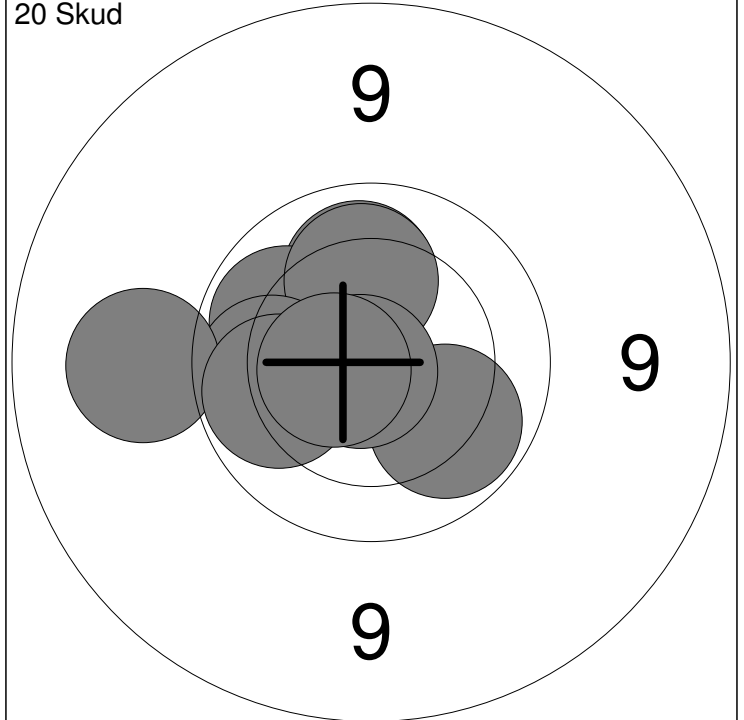
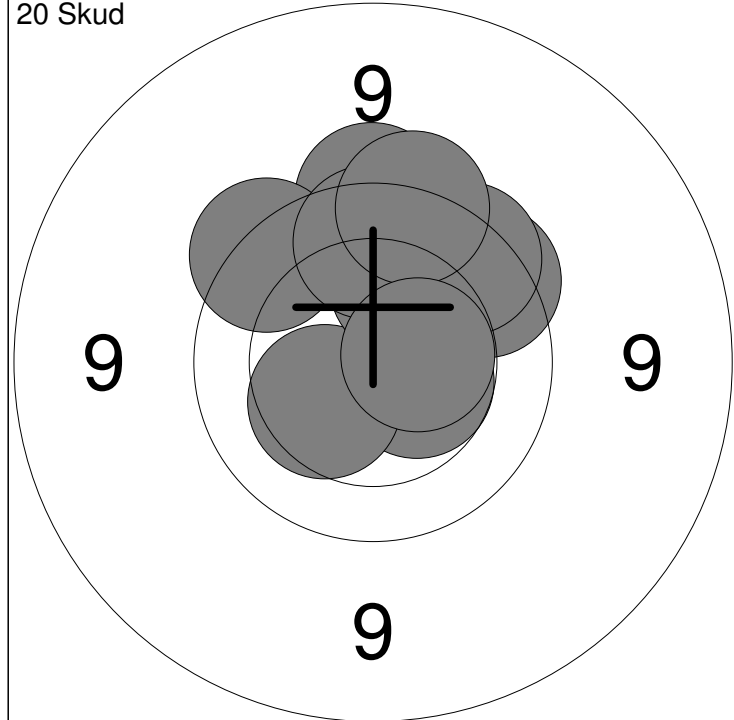

1: 10.5 →	6: 9.7 ↖	Serie	94 (1x)
2: 10.3 ↙	7: 9.7 ↗		
3: 10.1 ↗	8: 9.8 ↗	Total	94 (1x)
4: 9.6 ↗	9: 9.6 ↗		
5: 9.8 ↗	10: 10.5x →		

11: 10.2 ↗	16: 10.0 ↖	Serie	99 (2x)
12: 10.1 ↗	17: 9.2 ↖		
13: 10.0 ↖	18: 10.0 ↖	Total	193 (3x)
14: 10.1 ↗	19: 10.8x ↙		
15: 10.0 ↘	20: 10.6x ↖		

Hold 31	Skive 6	Aksel Nielsen		
15 meter		Hjørring Skytteforening		J2
		Nordjysk mesterskab 2019	Aalborg Skyttekreds	
Prøve 		1: 10.2 ↘ 2: 9.1 ← 3: 9.1 ↗ 4: 9.9 ↗ 5: 9.1 ↗ 6: 10.2 ↗ 7: 9.5 ↓		
		Serie	65 (0x)	
		Total	0 (0x)	
20 Skud 		1: 8.8 ← 2: 8.0 ← 3: 9.8 ← 4: 9.2 ↗ 5: 9.8 ↑ 6: 7.8 ↗ 7: 9.4 ↘ 8: 8.5 ↗ 9: 9.5 ↗ 10: 9.3 →		
		Serie	85 (0x)	
		Total	85 (0x)	
20 Skud 		11: 9.7 ↓ 12: 10.5x ↓ 13: 8.6 ↗ 14: 8.5 ← 15: 9.2 ↓ 16: 10.2 ↗ 17: 8.1 ← 18: 10.0 ↓ 19: 9.3 ← 20: 8.7 ↗		
		Serie	89 (1x)	
		Total	174 (1x)	

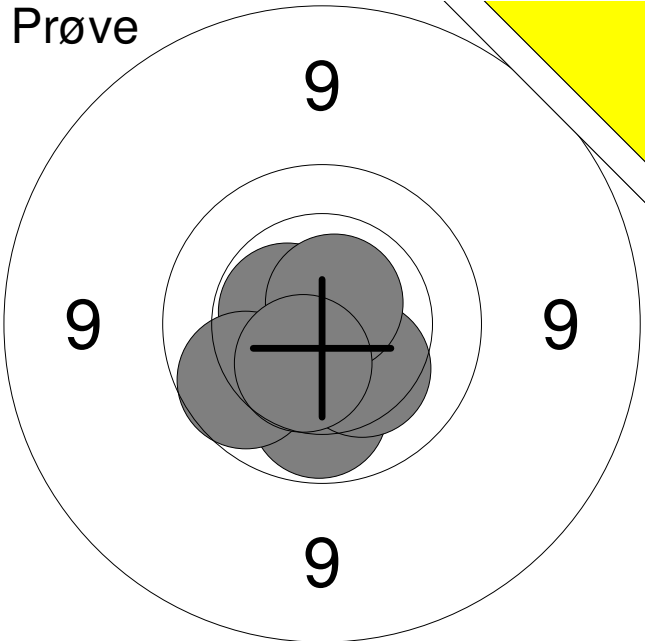
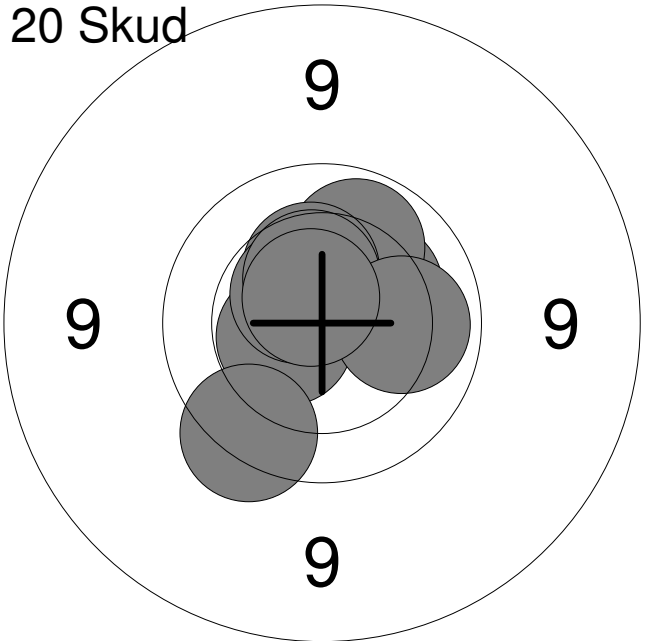
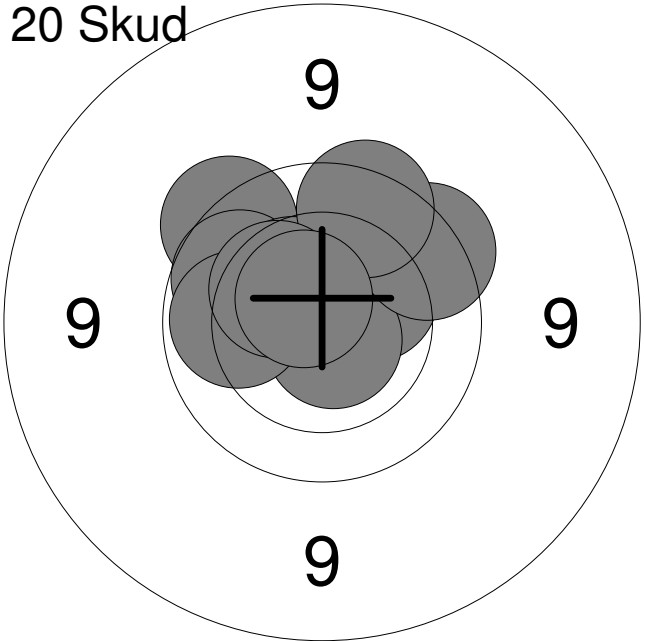
Hold 31	Skive 9	Mikkel_Bisgaard		
15 meter		Hobro Egnens Skytteforening		MJ1
		Nordjysk mesterskab 2019	Aalborg Skyttekreds	
Prøve		1:	10.0	↓
		2:	10.3	↘
		3:	10.4	↙
		4:	10.5x	←
		5:	9.9	↙
		6:	10.7x	↗
		7:	10.5	↓
		Serie	69 (2x)	
		Total	0 (0x)	
20 Skud		1:	10.2	↗
		2:	10.3	↘
		3:	10.0	↗
		4:	10.4	↑
		5:	10.5x	←
		6:	10.5x	↗
		7:	10.4	↑
		8:	10.1	→
		9:	10.6x	↑
		10:	9.7	↓
		Serie	99 (3x)	
		Total	99 (3x)	
20 Skud		11:	9.7	↗
		12:	10.3	↘
		13:	9.9	↙
		14:	10.7x	↓
		15:	10.0	←
		16:	9.7	↗
		17:	10.4	↗
		18:	9.8	↗
		19:	10.3	↗
		20:	10.6x	↗
		Serie	96 (2x)	
		Total	195 (5x)	

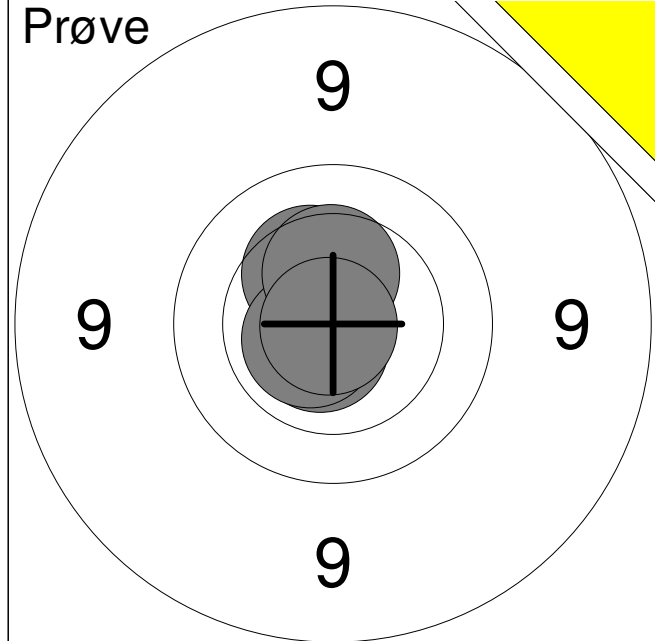

1:	10.3	↖
2:	10.7x	↙
3:	10.6x	←
4:	10.4	↑
5:	10.9x	↖
Serie		50 (3x)
Total		0 (0x)

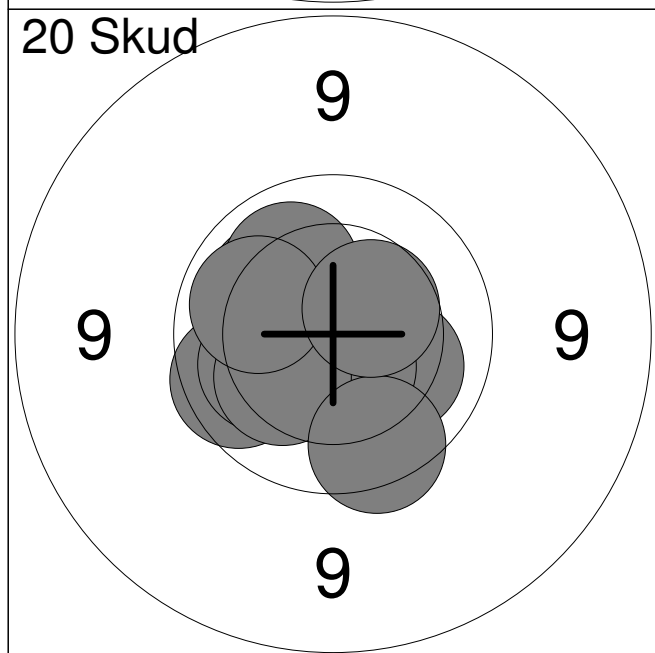

1:	10.1	↖
2:	9.9	←
3:	10.1	↖
4:	10.1	←
5:	10.2	↘
6:	10.6x	↙
7:	10.2	←
8:	10.1	↖
9:	9.8	↘
10:	10.4	↗
Serie		98 (1x)
Total		98 (1x)

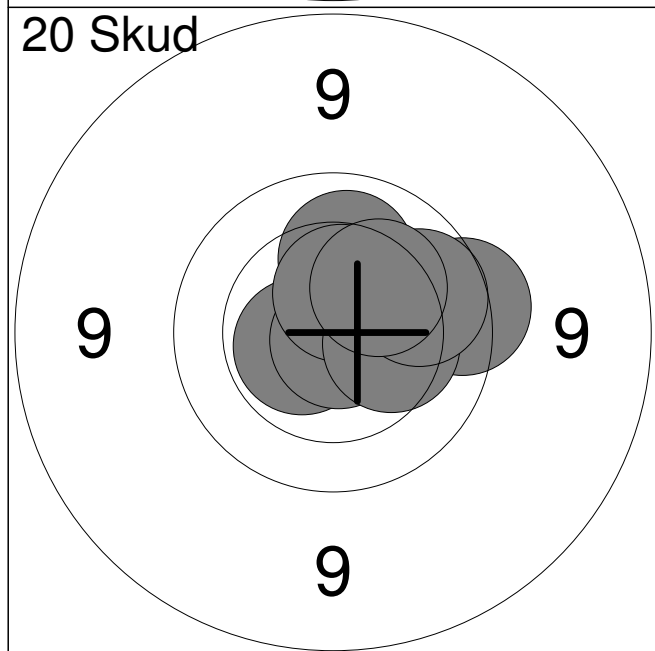

11:	10.9x	←
12:	10.1	↑
13:	10.6x	←
14:	10.8x	→
15:	10.9x	↘
16:	10.5x	↑
17:	9.7	→
18:	10.3	→
19:	9.9	↗
20:	10.2	↗
Serie		98 (5x)
Total		196 (6x)

Hold 31	Skive 11	Asbjoern_Eilertsen		
15 meter		Hobro Egnens Skytteforening		BK4
		Nordjysk mesterskab 2019	Aalborg Skyttekreds	
Prøve 		1: 9.8 ↗ 2: 9.7 ↖ 3: 9.6 ↗ 4: 9.9 ↗ 5: 9.4 ↘ 6: 10.4 ↑ 7: 10.4 ←	Serie 65 (0x) Total 0 (0x)	
20 Skud 		1: 10.5 ← 2: 10.2 ← 3: 9.9 ← 4: 10.2 ↗ 5: 10.6x ↓ 6: 9.7 ↗ 7: 10.6x ↓ 8: 10.6x ← 9: 10.4 ↘ 10: 10.1 ←	Serie 98 (3x) Total 98 (3x)	
20 Skud 		11: 9.8 ↗ 12: 10.0 ↘ 13: 10.0 ↘ 14: 10.2 ↘ 15: 9.9 ↘ 16: 10.5x ← 17: 10.2 ↘ 18: 9.8 ↓ 19: 8.7 → 20: 10.8x →	Serie 95 (2x) Total 193 (5x)	

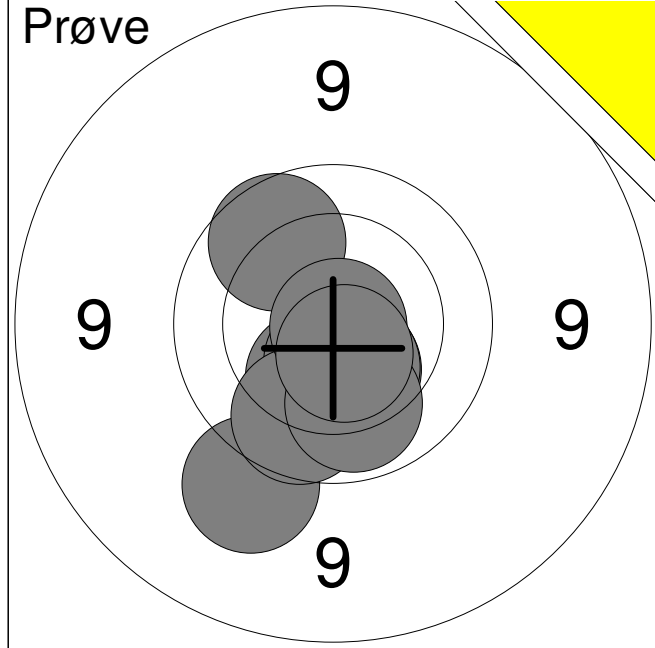

1:	9.9	↗
2:	9.4	↘
3:	10.4	↘
4:	10.3	↘
5:	10.5x	↘
6:	9.9	↘
7:	10.4	↘
8:	10.9x	↘
9:	10.0	↘
10:	10.6x	↘
Serie		97 (3x)
Total		0 (0x)

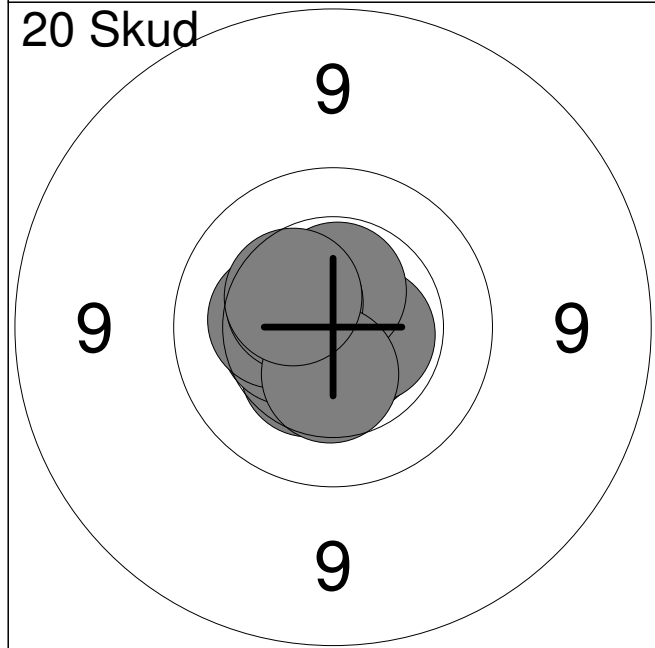

1:	10.7x	↘
2:	10.7x	↘
3:	10.4	↘
4:	10.6x	→
5:	10.6x	↑
6:	10.5	←
7:	10.3	←
8:	10.4	↗
9:	10.4	↘
10:	10.4	↗
Serie		100 (4x)
Total		100 (4x)

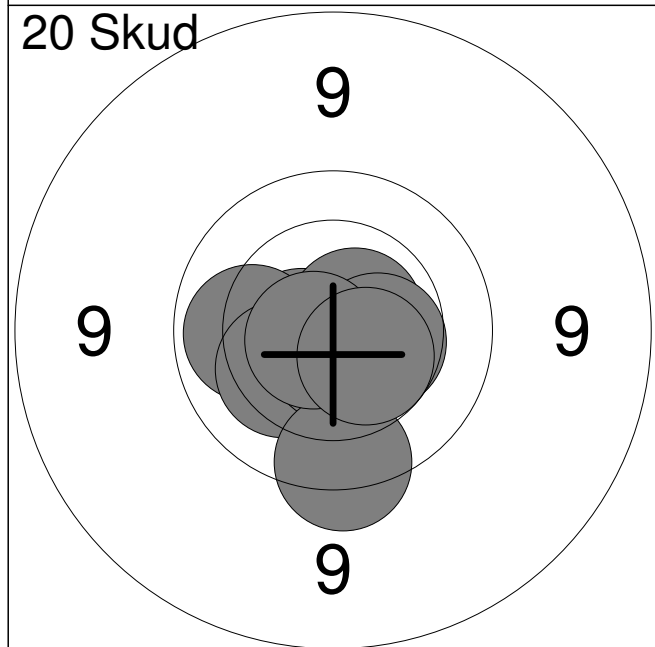

11:	10.6x	←
12:	10.1	←
13:	10.8x	↘
14:	10.3	↘
15:	10.7x	↘
16:	10.7x	↗
17:	10.4	→
18:	9.7	↘
19:	10.7x	↙
20:	10.5	↘
Serie		99 (5x)
Total		199 (9x)

	Nordjysk mesterskab 2019	Aalborg Skyttekreds
--	--------------------------	---------------------

Prøve

1:	9.9	↗
2:	10.1	↓
3:	10.6x	↓
4:	10.1	→
5:	10.2	↓
6:	10.6x	↓
7:	10.5x	↗

Serie	69 (3x)
Total	0 (0x)

20 Skud

1:	10.5	←
2:	10.7x	→
3:	10.7x	↖
4:	10.8x	↘
5:	10.6x	←
6:	10.3	→
7:	10.5x	→
8:	10.5x	←
9:	10.8x	↖
10:	10.7x	↗

Serie	100 (8x)
Total	100 (8x)

20 Skud

11:	10.8x	↑
12:	10.1	↘
13:	10.4	↘
14:	10.7x	↑
15:	10.6x	←
16:	10.7x	↗
17:	10.5	←
18:	10.1	↘
19:	10.7x	↓
20:	10.5x	←

Serie	100 (6x)
Total	200 (14x)

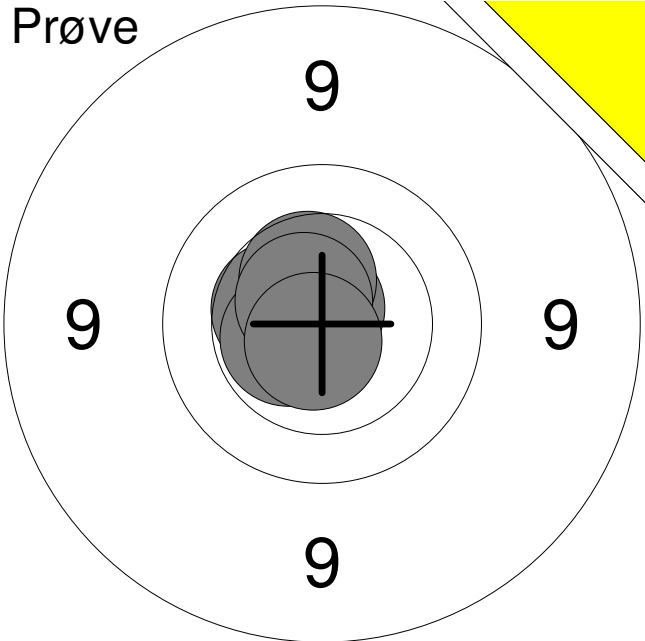
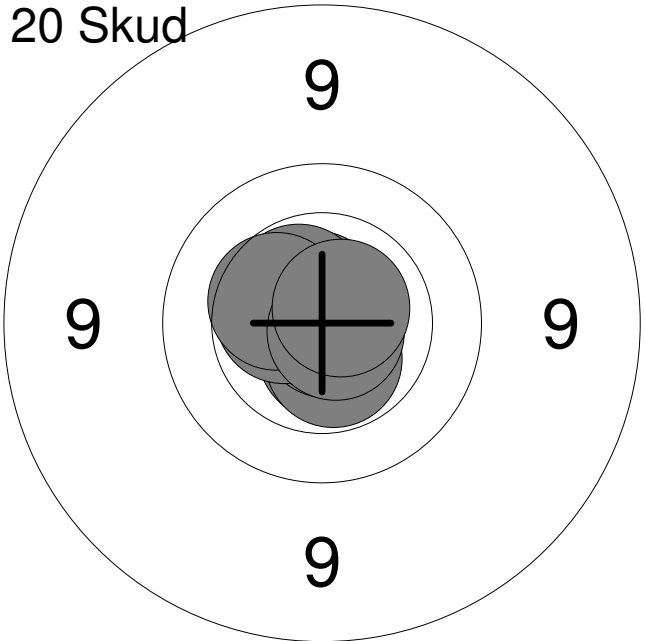
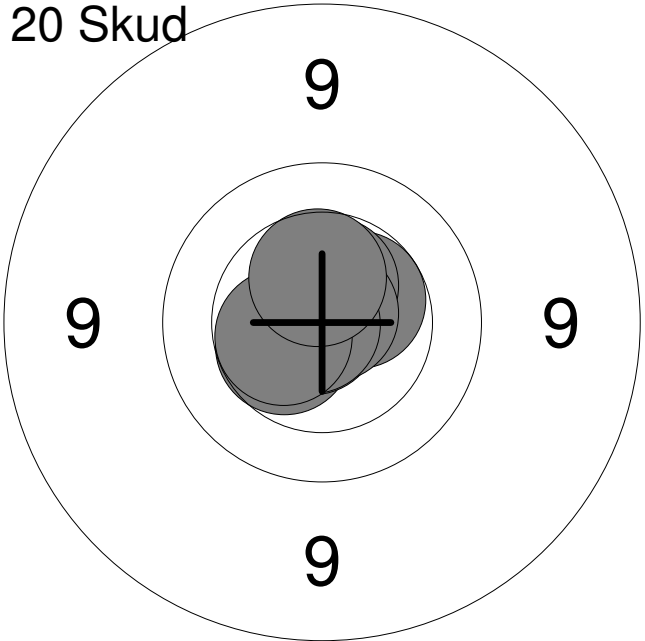
Hold 32	Skive 2	Thomas Groen_Bendixen		
15 meter		Hjørring Skytteforening		MJ1
		Nordjysk mesterskab 2019	Aalborg Skyttekreds	
Prøve		1:	10.8x	↑
		2:	10.5	↖
		3:	10.6x	↖
		4:	10.4	↑
		5:	10.6x	↗
		6:	10.7x	↘
		Serie		60 (4x)
		Total		0 (0x)
20 Skud		1:	10.6x	↓
		2:	10.5x	↓
		3:	10.9x	↘
		4:	10.7x	↗
		5:	10.5x	↗
		6:	10.8x	↘
		7:	10.5x	↖
		8:	10.4	↖
		9:	10.8x	↘
		10:	10.7x	↗
		Serie		100 (9x)
		Total		100 (9x)
20 Skud		11:	10.7x	↑
		12:	10.5	↗
		13:	10.8x	↖
		14:	10.5	↖
		15:	10.8x	↖
		16:	10.5x	↑
		17:	10.8x	↗
		18:	10.8x	↖
		19:	10.5x	↖
		20:	10.5	↑
		Serie		100 (7x)
		Total		200 (16x)

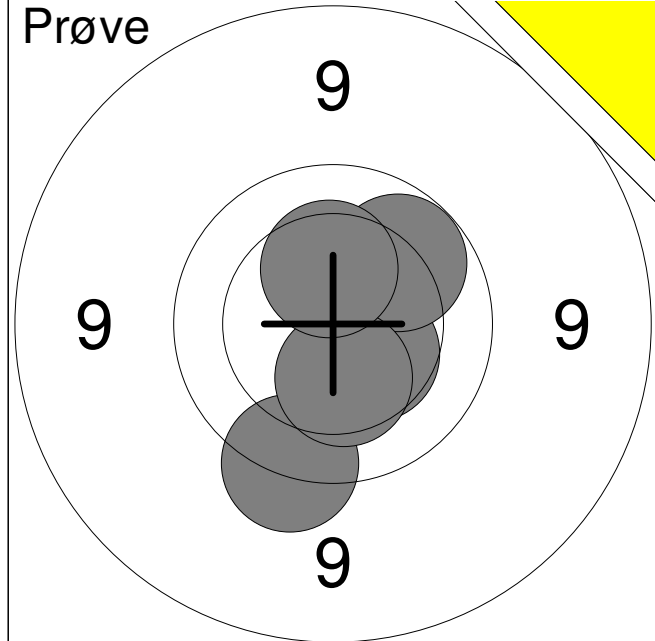

1:	9.6	↓
2:	10.4	↘
3:	10.0	↗
4:	10.3	↓
5:	10.3	↑
Serie	49 (0x)	
Total	0 (0x)	

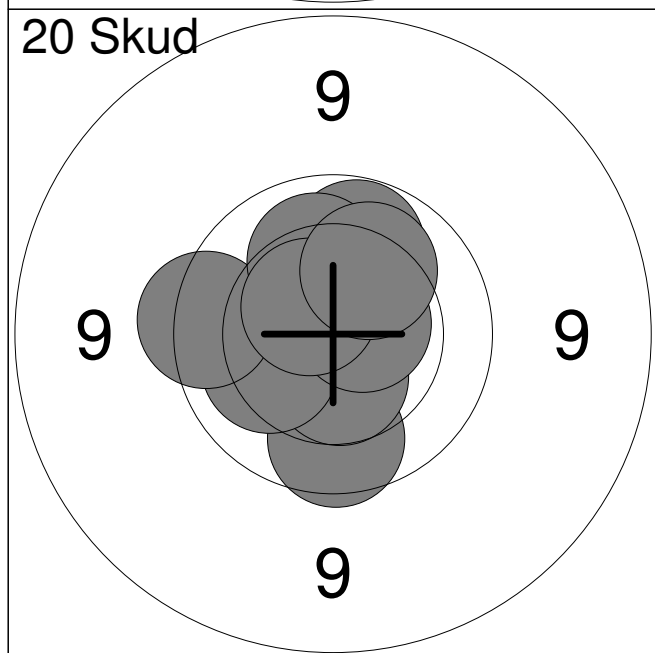

1:	10.0	↑
2:	9.9	↓
3:	10.6x	↗
4:	10.5	↓
5:	10.2	↙
6:	9.7	↙
7:	10.6x	↗
8:	10.1	↑
9:	10.6x	↗
10:	10.1	↗
Serie	98 (3x)	
Total	98 (3x)	

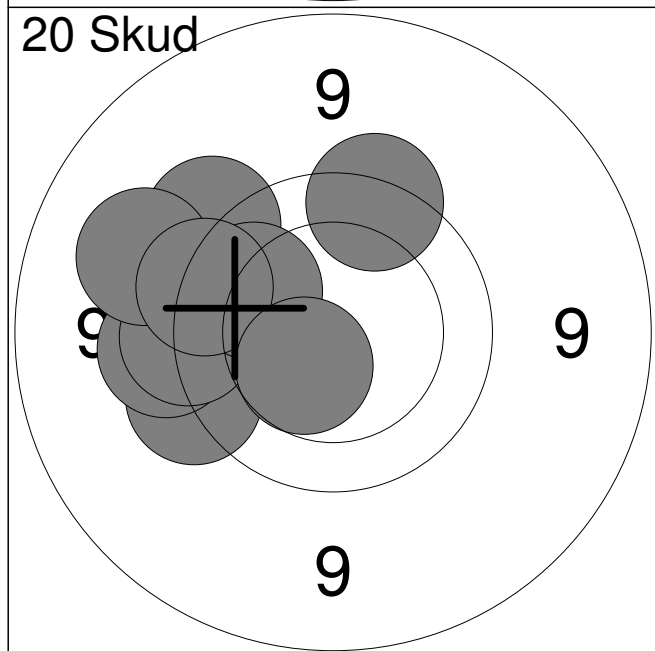

11:	9.8	↙
12:	9.5	↗
13:	9.6	↙
14:	9.5	↙
15:	9.7	↑
16:	9.6	↙
17:	9.2	↙
18:	10.0	↗
19:	9.7	↙
20:	10.5	↓
Serie	92 (0x)	
Total	190 (3x)	

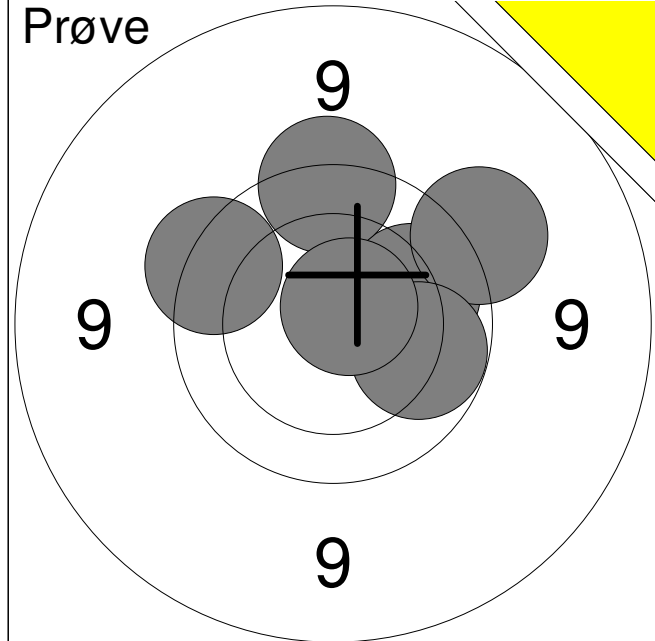

1:	10.0	➔
2:	9.7	➤
3:	9.6	⬆
4:	9.4	➔
5:	10.0	➤
6:	10.7x	➔
Serie		57 (1x)
Total		0 (0x)

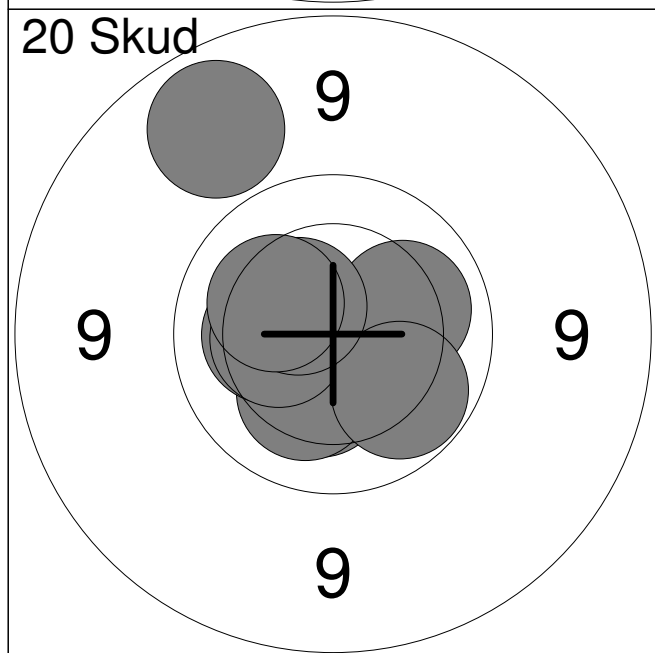

1:	10.3	⬇
2:	10.4	➔
3:	10.2	⬇
4:	10.1	➔
5:	10.3	➤
6:	9.0	➔
7:	10.3	➤
8:	10.0	⬇
9:	10.5	➔
10:	10.2	➔
Serie		99 (0x)
Total		99 (0x)

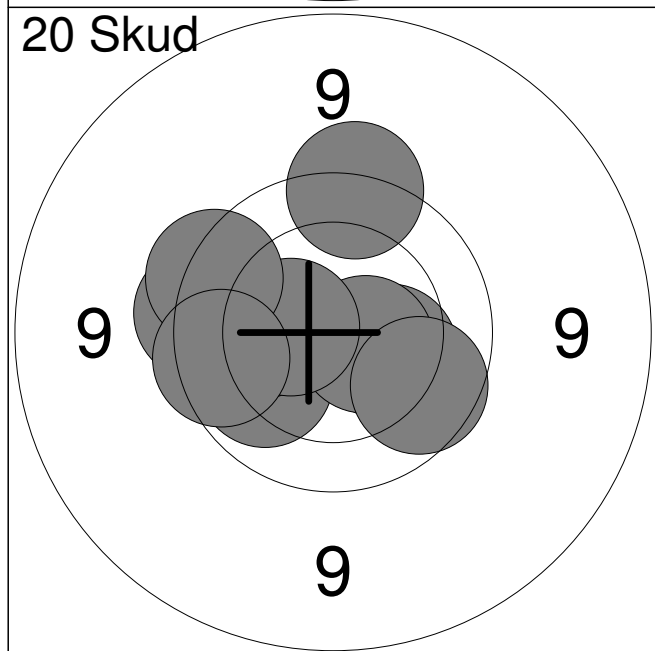

11:	10.3	➔
12:	9.7	➤
13:	10.0	➤
14:	10.6x	➔
15:	9.6	⬆
16:	10.1	➤
17:	9.9	⬇
18:	10.5	➤
19:	9.7	➤
20:	9.8	➤
Serie		95 (1x)
Total		194 (1x)

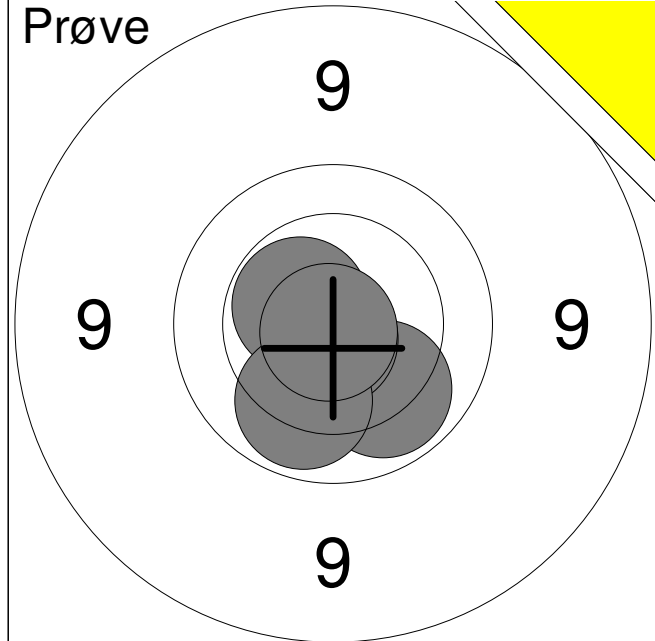

1:	10.0	↘
2:	10.8x	↓
3:	10.5x	↗
4:	10.0	↓
5:	10.9x	↓
Serie		50 (3x)
Total		0 (0x)

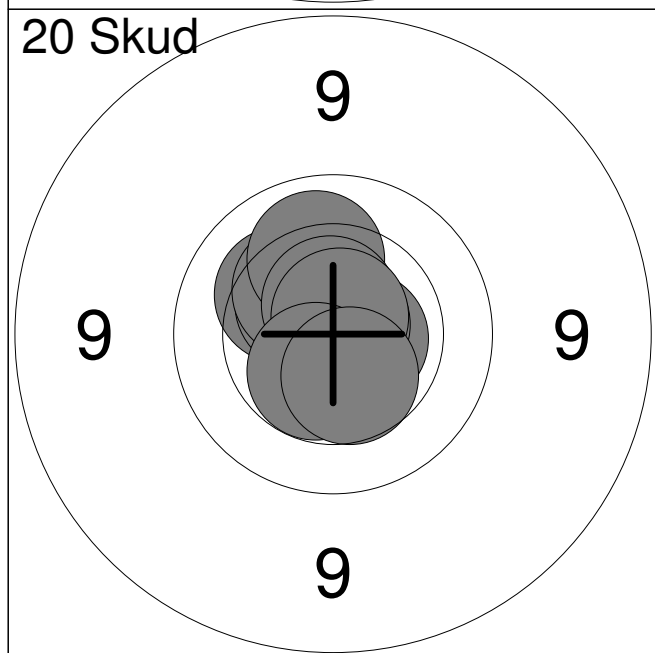

1:	10.2	↗
2:	10.7x	→
3:	10.5	↗
4:	10.3	↗
5:	10.8x	↗
6:	10.1	↑
7:	10.6x	↑
8:	10.7x	↗
9:	10.5x	↓
10:	10.5	↓
Serie		100 (5x)
Total		100 (5x)

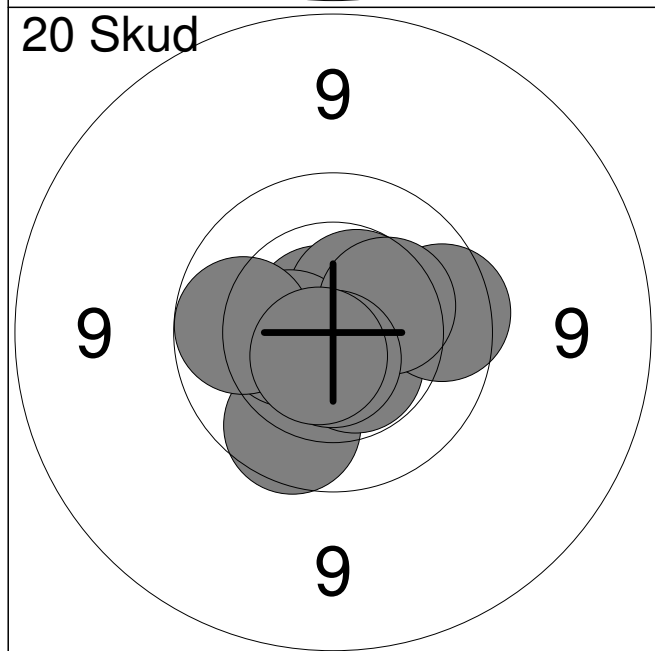

11:	9.9	↓
12:	10.5x	↓
13:	10.7x	↗
14:	10.5x	↗
15:	9.8	→
16:	10.5	←
17:	10.3	↗
18:	10.0	←
19:	10.7x	↓
20:	10.7x	↓
Serie		98 (5x)
Total		198 (10x)

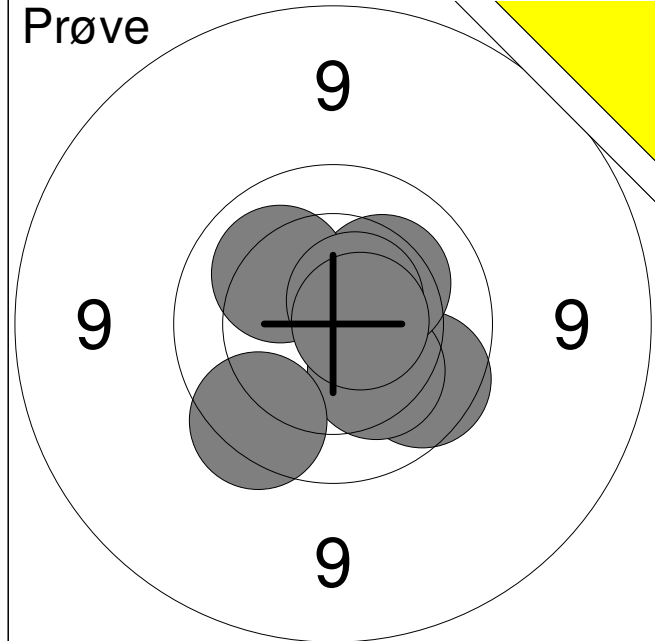

1:	9.9	↘
2:	10.2	↘
3:	10.2	↗
4:	10.1	↗
5:	10.6x	↗
6:	9.8	↘
7:	10.6x	→
Serie		68 (2x)
Total		0 (0x)

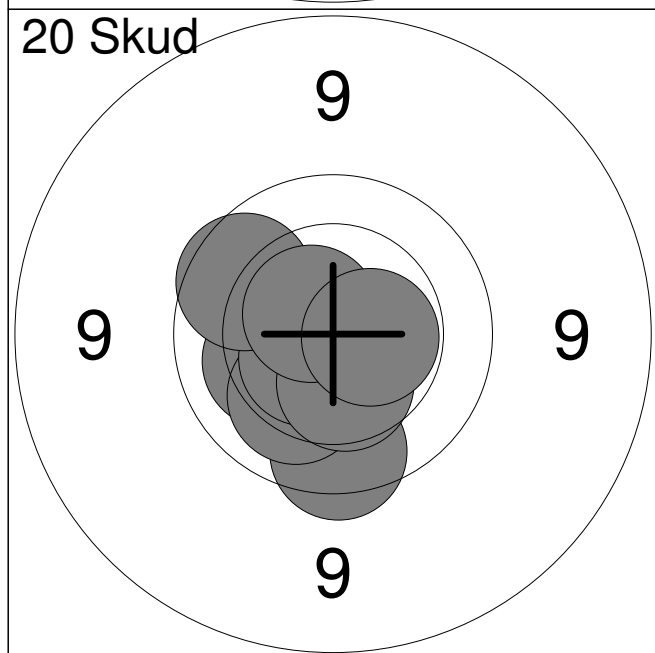

1:	10.7x	↙
2:	10.2	←
3:	10.8x	↘
4:	9.8	↓
5:	10.2	↘
6:	10.6x	↙
7:	10.4	↘
8:	9.9	↗
9:	10.6x	↗
10:	10.5x	→
Serie		98 (5x)
Total		98 (5x)

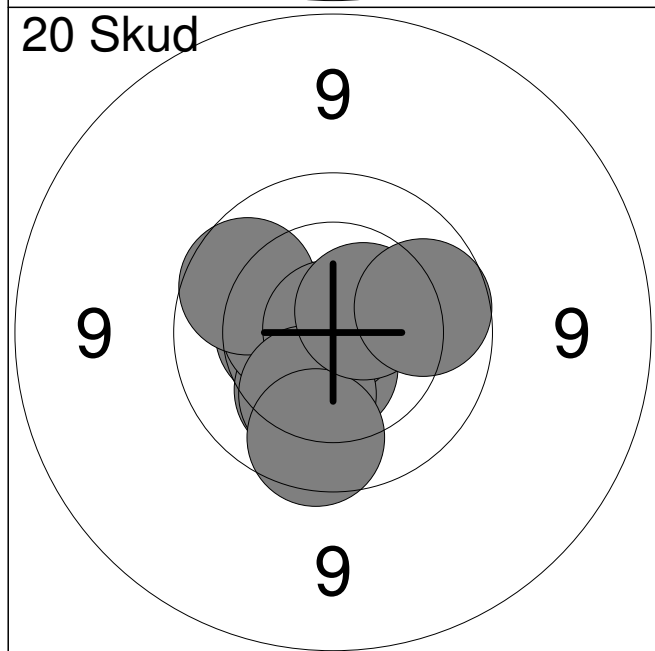

11:	10.4	←
12:	10.2	↘
13:	10.5	←
14:	9.9	↗
15:	10.6x	↓
16:	10.9x	↑
17:	10.2	↘
18:	9.9	↘
19:	10.5x	↗
20:	9.9	→
Serie		97 (3x)
Total		195 (8x)

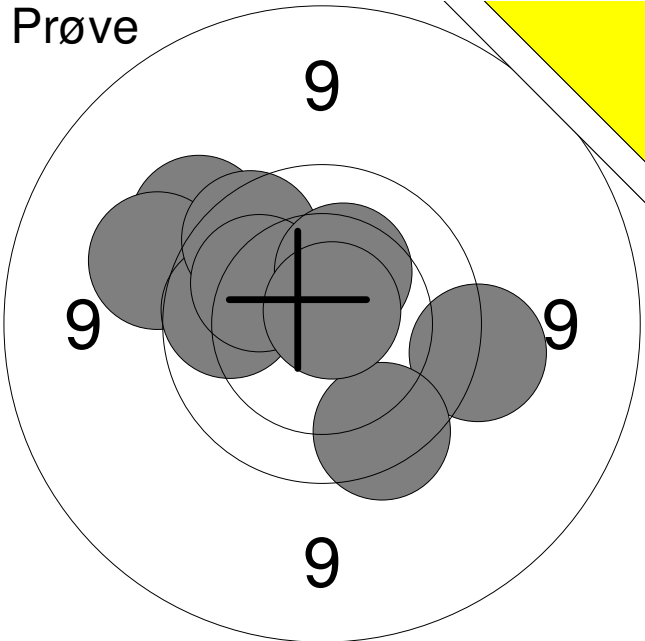
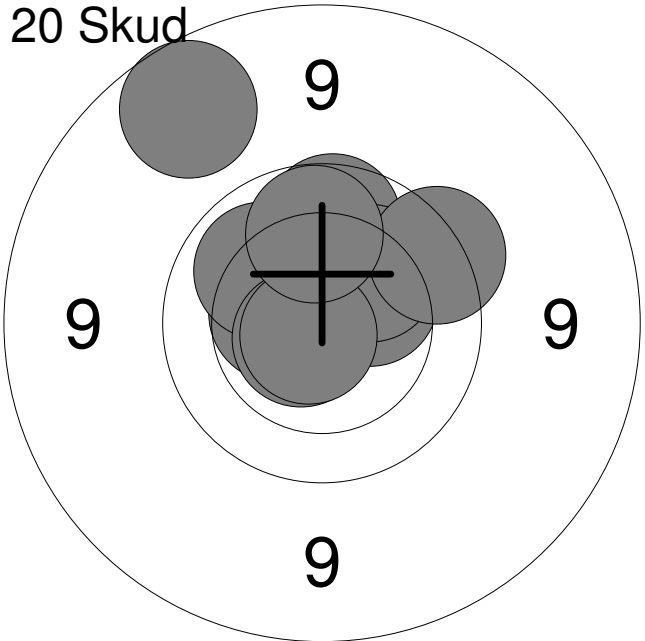
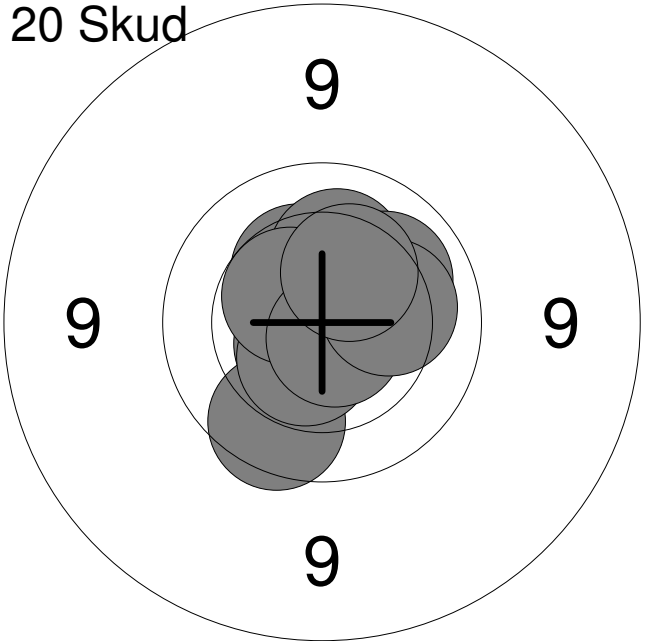
Hold 32	Skive 8	Lai Andersen		
15 meter		Vilsted Skytteforening		MBK4
		Nordjysk mesterskab 2019	Aalborg Skyttekreds	
Prøve 		1: 9.5 → 2: 9.7 ↓ 3: 9.5 ↗ 4: 9.4 ↖ 5: 9.9 ← 6: 9.8 ↗ 7: 10.1 ↗ 8: 10.3 ↑ 9: 10.8x ↗		
		Serie		84 (1x)
		Total		0 (0x)
20 Skud 		1: 9.9 ↑ 2: 10.4 ← 3: 10.4 ↗ 4: 10.2 ↗ 5: 8.9 ↗ 6: 9.7 ↗ 7: 10.1 ↗ 8: 10.7x ← 9: 10.7x ← 10: 10.0 ↑		
		Serie		96 (2x)
		Total		96 (2x)
20 Skud 		11: 10.3 ↗ 12: 10.6x ↓ 13: 10.2 ↑ 14: 9.8 ↓ 15: 10.5x ↓ 16: 10.1 ↗ 17: 10.5x ↗ 18: 10.7x ↓ 19: 10.2 → 20: 10.3 ↗		
		Serie		99 (4x)
		Total		195 (6x)

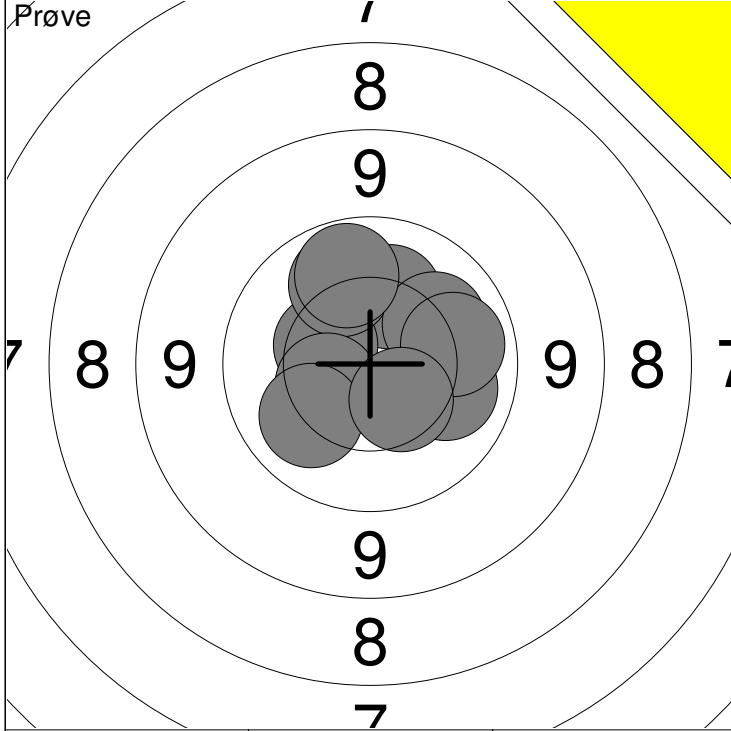

1: 10.2 ↗	6: 10.1 →
2: 10.4 ↖	7: 10.4 ↖
3: 10.1 →	8: 10.1 ↙
4: 10.1 ↗	9: 10.0 ↗
5: 10.2 ↗	10: 10.4 ↘

Serie	100 (0x)
Total	0 (0x)

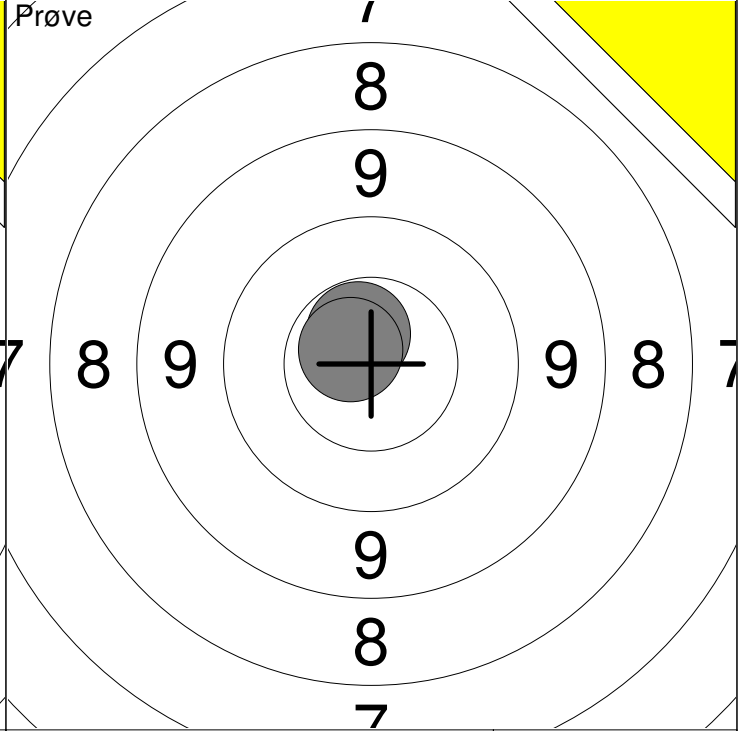

11: 10.6x ↗	12: 10.7x ↖
-------------	-------------

Serie	20 (2x)
Total	0 (0x)

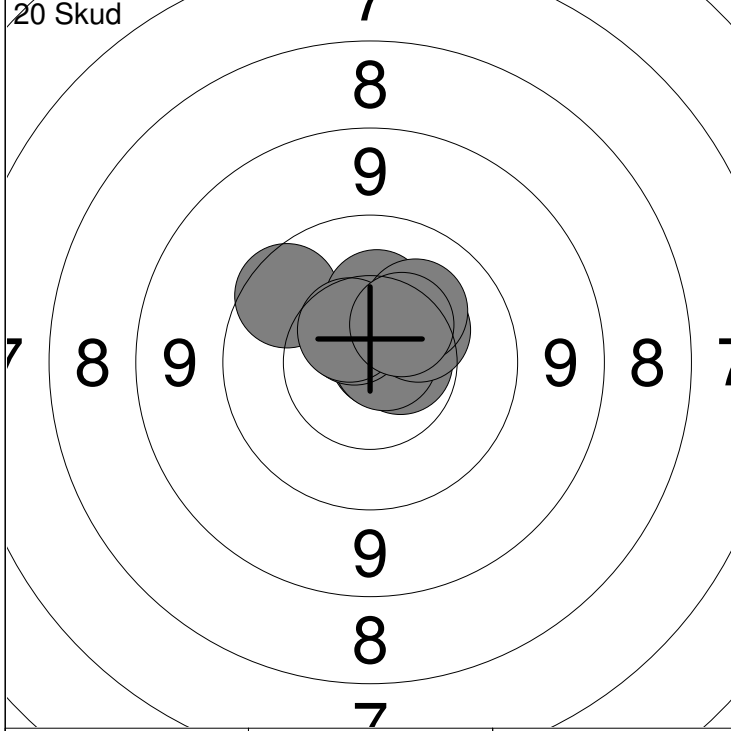

1: 9.8 ↖	6: 10.6x ↗
2: 10.6x →	7: 10.3 ↗
3: 10.3 ↗	8: 10.2 ↗
4: 10.8x ↗	9: 10.5 ↖
5: 10.8x →	10: 10.4 ↗

Serie	99 (4x)
Total	99 (4x)

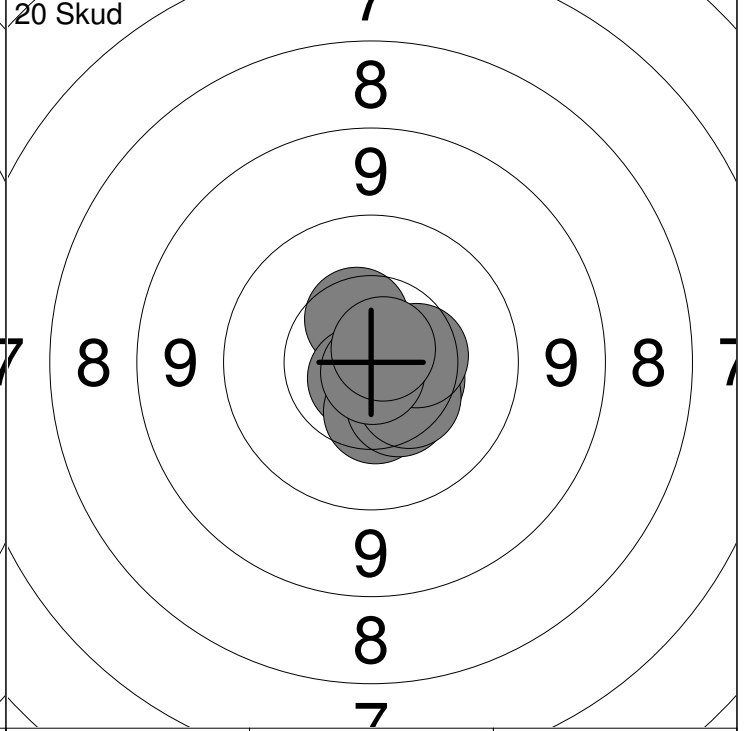

11: 10.5 ↗	16: 10.4 ↘
12: 10.7x ↙	17: 10.4 ↘
13: 10.4 ↘	18: 10.5 →
14: 10.5 →	19: 10.8x ↘
15: 10.6 →	20: 10.8x ↗

Serie	100 (3x)
Total	199 (7x)

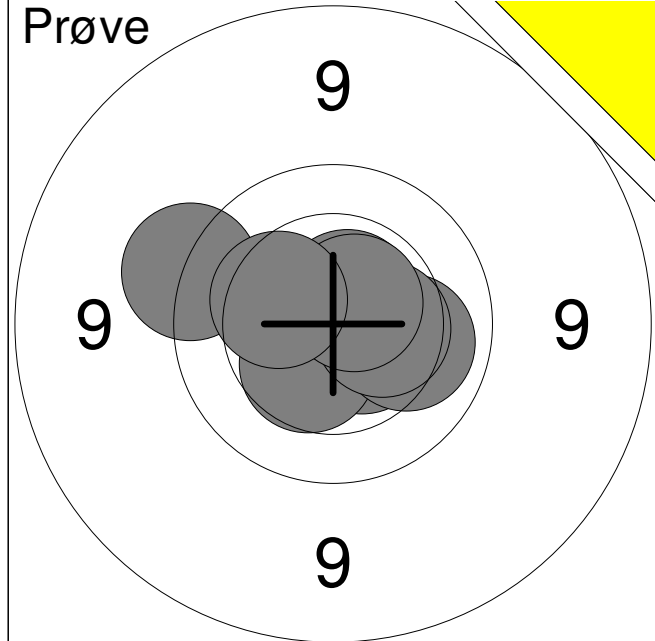

1:	10.5x	↙
2:	10.7x	↙
3:	10.6x	↘
4:	10.4	↙
5:	10.6x	↗
6:	9.6	↖
7:	10.1	→
8:	10.4	→
9:	10.6x	↗
10:	10.3	↖
Serie		99 (5x)
Total		0 (0x)

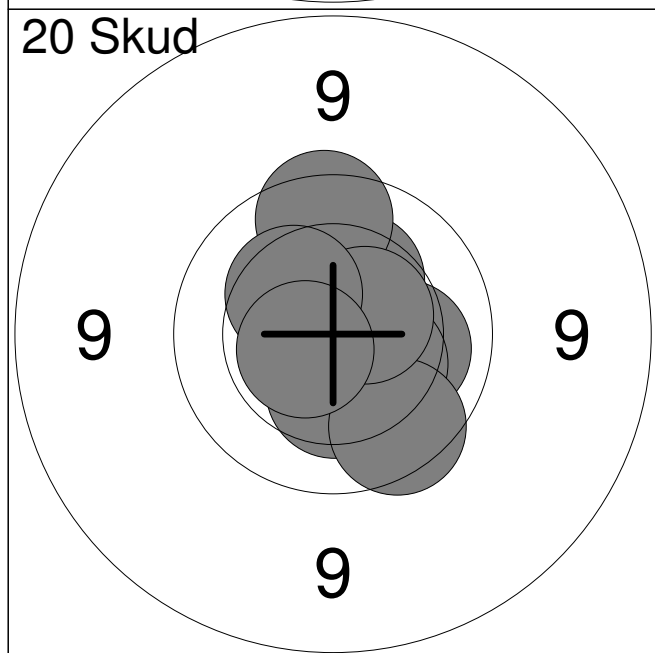

1:	10.3	↗
2:	10.6x	↗
3:	9.8	↑
4:	10.2	→
5:	10.3	↓
6:	10.3	↘
7:	9.8	↘
8:	10.5x	↗
9:	10.3	↗
10:	10.6x	↖
Serie		98 (3x)
Total		98 (3x)

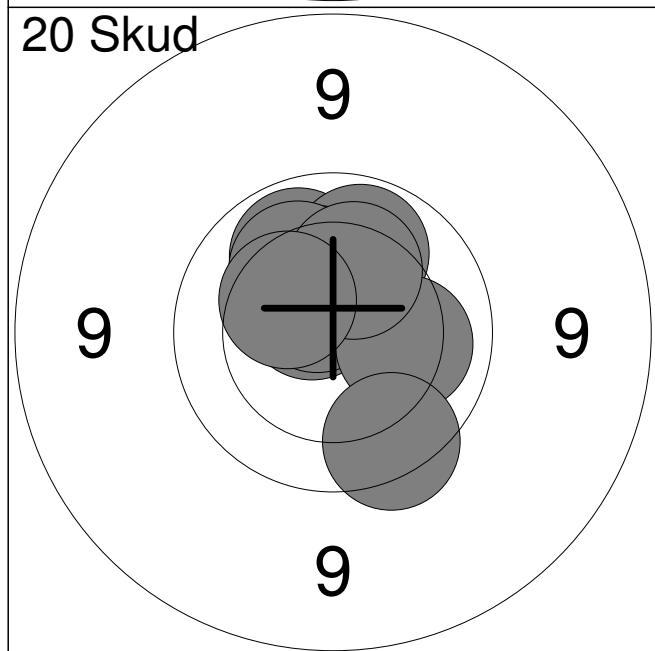

11:	10.6x	↗
12:	10.0	↗
13:	10.0	↗
14:	10.6x	↗
15:	10.3	↗
16:	10.2	↗
17:	10.2	→
18:	9.7	↘
19:	10.2	↗
20:	10.3	↖
Serie		99 (2x)
Total		197 (5x)

Hold 32	Skive 11	Mathias L. Mikkelsen		
15 meter		Hobro Egnens Skytteforening		MBK1
		Nordjysk mesterskab 2019	Aalborg Skyttekreds	
Prøve		1:	10.1	↘
		2:	9.9	↓
		3:	10.2	↖
		4:	10.6x	↓
		5:	10.1	↘
		6:	10.6x	↗
		7:	10.2	↘
		8:	9.9	↓
		9:	10.2	↗
		10:	10.5	↗
		Serie		98 (2x)
		Total		0 (0x)
20 Skud		1:	10.5	↗
		2:	10.2	↗
		3:	10.8x	↗
		4:	10.8x	↘
		5:	10.8x	→
		6:	10.3	↖
		7:	10.6x	↗
		8:	10.8x	↖
		9:	10.8x	↗
		10:	10.6x	↓
		Serie		100 (7x)
		Total		100 (7x)
20 Skud		11:	10.8x	↓
		12:	10.2	↘
		13:	10.7x	→
		14:	10.6x	↓
		15:	10.2	↘
		16:	10.7x	→
		17:	10.5	↖
		18:	10.4	→
		19:	10.8x	↗
		20:	10.8x	↖
		Serie		100 (6x)
		Total		200 (13x)

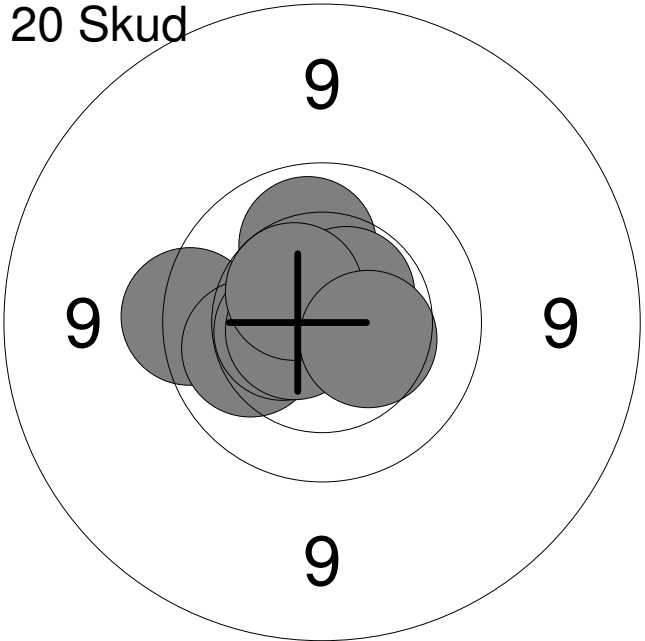
Hold	Skive	William Roenn	
32	12		
15 meter		Aalborg Skyttekreds	BK2
		Nordjysk mesterskab 2019	Aalborg Skyttekreds
Prøve		1: 9.8 ↑ 2: 10.0 ↗ 3: 9.4 ↑ 4: 9.7 ↗ 5: 10.4 ↑ 6: 9.8 ↑ 7: 10.7x ↓ 8: 10.3 ← 9: 10.6x ↗	
		Serie	86 (2x)
		Total	0 (0x)
20 Skud		1: 10.4 ↘ 2: 10.8x → 3: 9.7 ↗ 4: 10.6x ← 5: 10.6x ↘ 6: 10.5x ← 7: 10.7x → 8: 10.3 ↘ 9: 10.2 ↗ 10: 9.9 ↑	
		Serie	98 (5x)
		Total	98 (5x)
20 Skud		11: 10.1 ↑ 12: 10.6x ↗ 13: 9.7 ← 14: 10.5x ← 15: 10.1 ← 16: 10.5x ← 17: 10.7x ↗ 18: 10.6x ← 19: 10.5 ↗ 20: 10.4 →	
		Serie	99 (5x)
		Total	197 (10x)

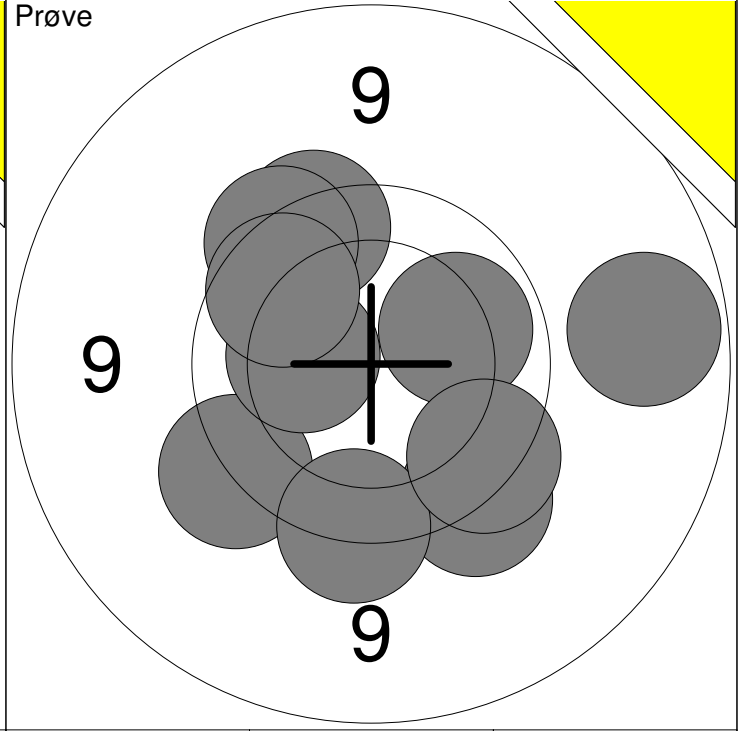
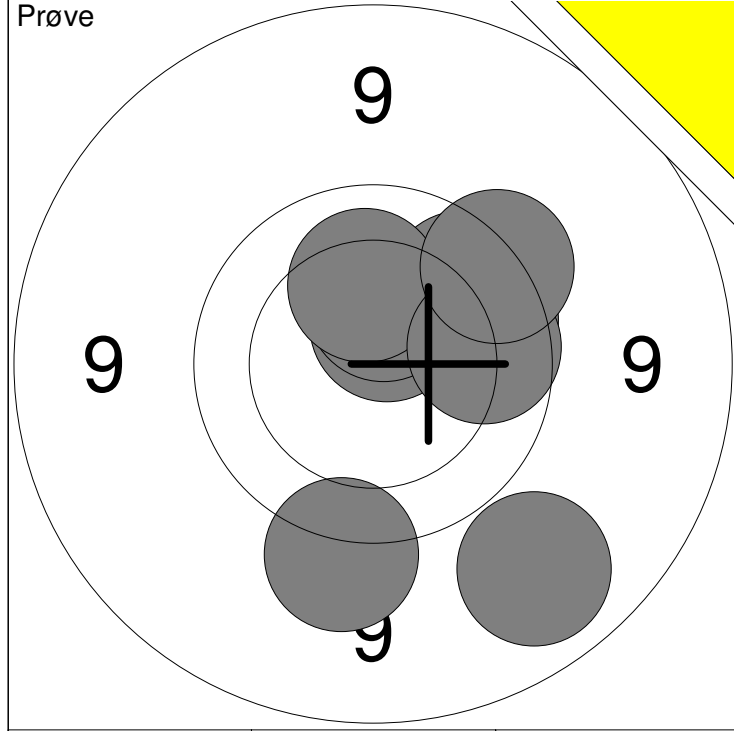

1: 10.5x ↑	7: 9.9 →	Serie	84 (1x)
2: 9.9 ↗	8: 9.1 ↘		
3: 10.4 ↑	9: 9.6 ↗	Total	0 (0x)
5: 9.9 →	10: 9.4 ↓		
6: 10.2 ↑			

11: 9.7 ↑	16: 9.0 →	Serie	92 (0x)
12: 9.7 ↗	17: 10.1 →		
13: 9.6 ↙	18: 9.9 ↖	Total	0 (0x)
14: 10.3 ←	19: 9.6 ↓		
15: 9.6 ↓	20: 9.7 ↘		

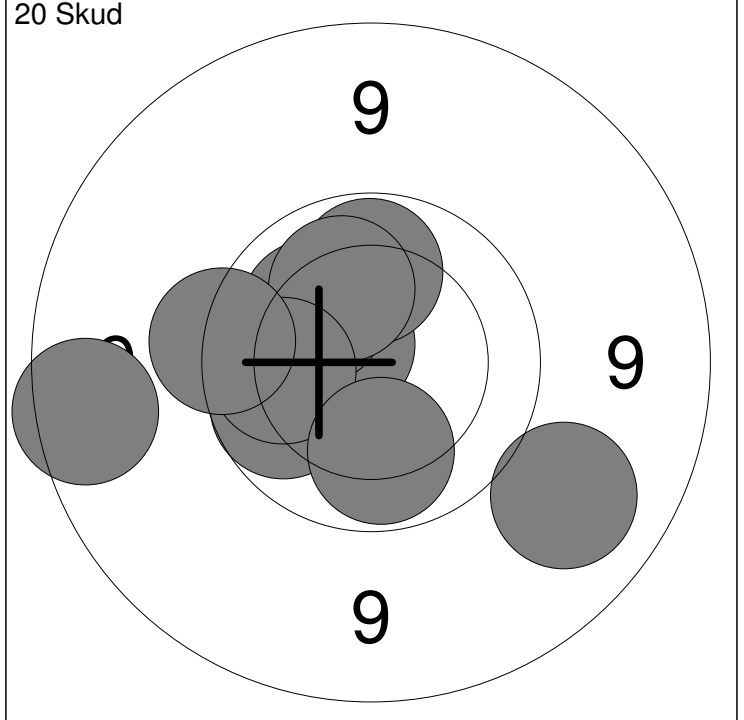
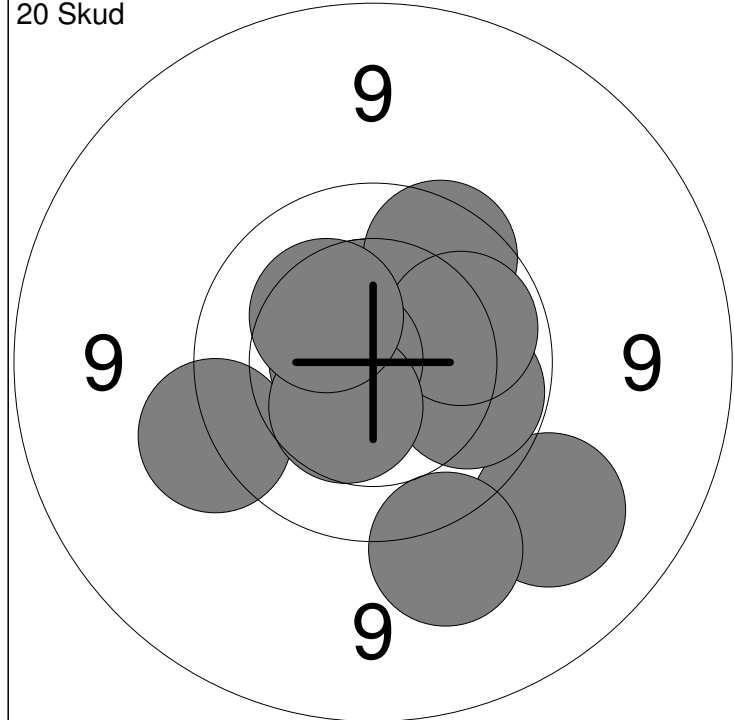

1: 9.2 ↘	6: 9.8 ↗	Serie	96 (2x)
2: 9.6 ←	7: 10.0 →		
3: 10.0 →	8: 10.7x ←	Total	96 (2x)
4: 9.4 ↓	9: 10.4 ↘		
5: 10.5x ↑	10: 10.3 ↖		

11: 10.6x ↖	16: 10.0 ←	Serie	95 (1x)
12: 10.2 ↖	17: 10.0 ↓		
13: 10.0 ↑	18: 8.9 ←	Total	191 (3x)
14: 10.1 ↗	19: 9.6 ←		
15: 9.9 ←	20: 9.1 ↘		

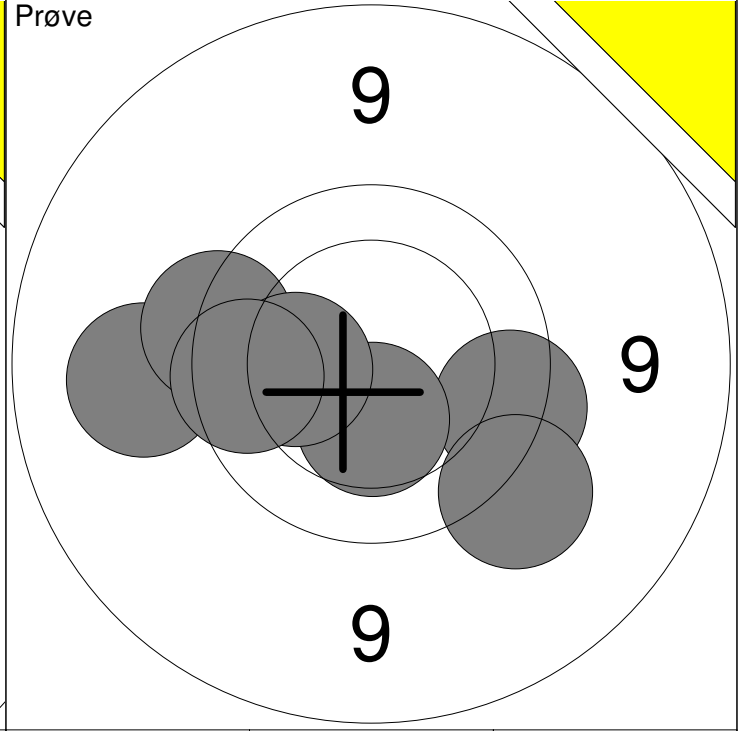
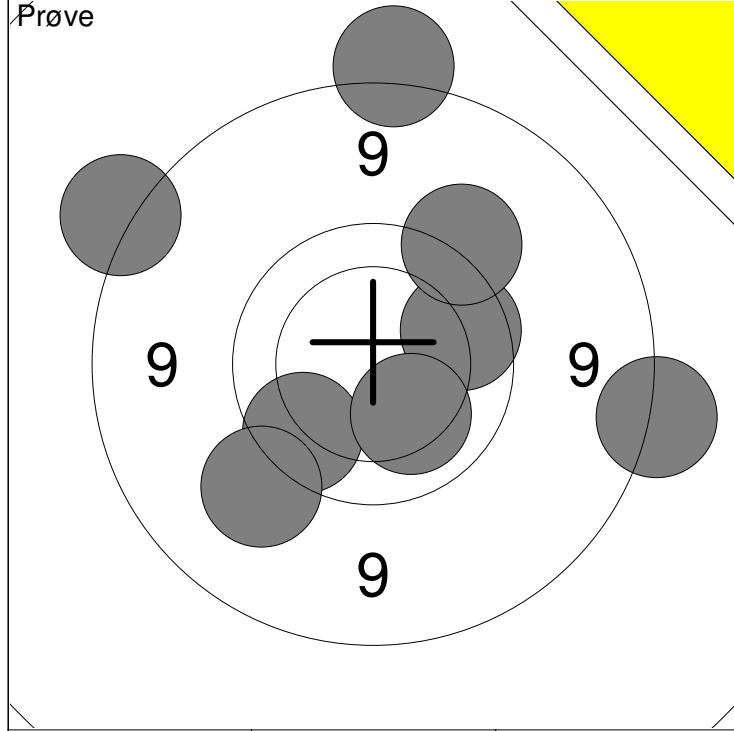

2: 9.9 →	8: 9.5 ↗	Serie	70 (0x)
3: 9.8 ↙	9: 8.6 →		
5: 9.3 ↙	10: 8.6 ↑	Total	0 (0x)
6: 8.6 ↗			
7: 10.2 ↘			

11: 9.7 →	17: 10.2 ←	Serie	65 (0x)
12: 9.2 ←	18: 9.8 ←		
13: 10.4 ↓		Total	0 (0x)
14: 9.6 ←			
15: 9.4 ↘			

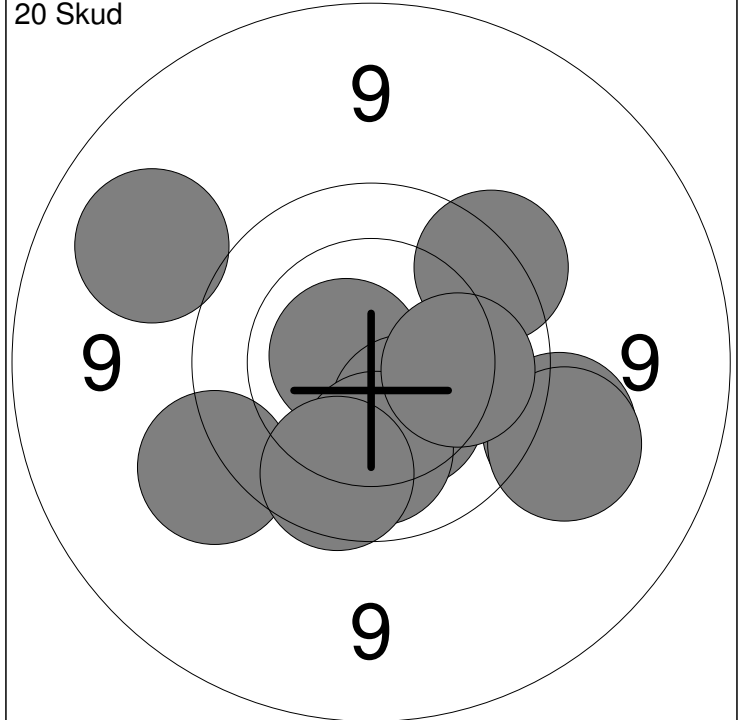
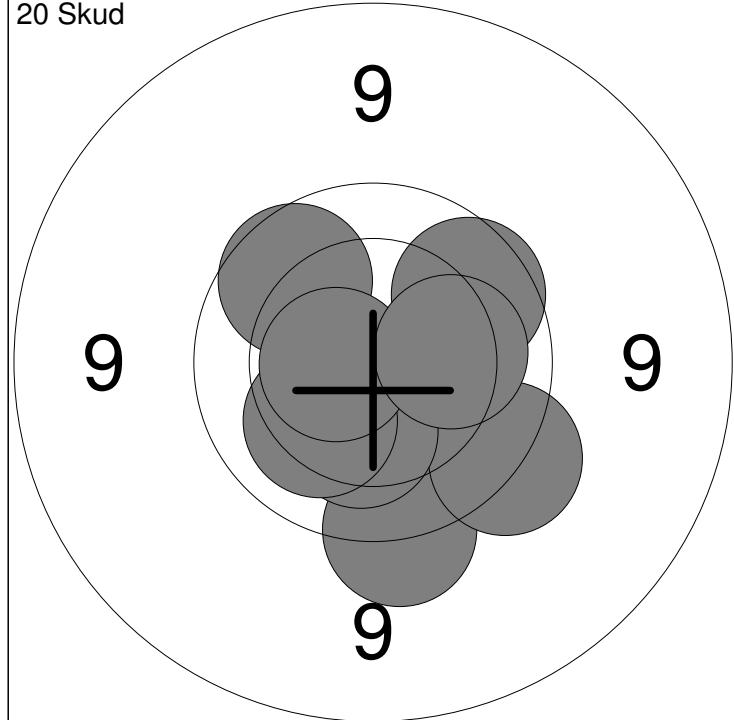

1: 10.5 →	6: 10.3 ↓	Serie	96 (1x)
2: 9.9 ↗	7: 9.9 ↗		
3: 10.1 ↘	8: 10.2 ↙	Total	96 (1x)
4: 9.6 ↘	9: 10.6x ←		
5: 9.6 ↘	10: 10.2 →		

11: 10.7x ←	16: 10.4 ↘	Serie	94 (1x)
12: 9.5 ↙	17: 10.1 ↓		
13: 9.4 →	18: 10.1 →	Total	190 (2x)
14: 9.3 →	19: 9.1 ↙		
15: 9.7 ↗	20: 9.9 ↓		

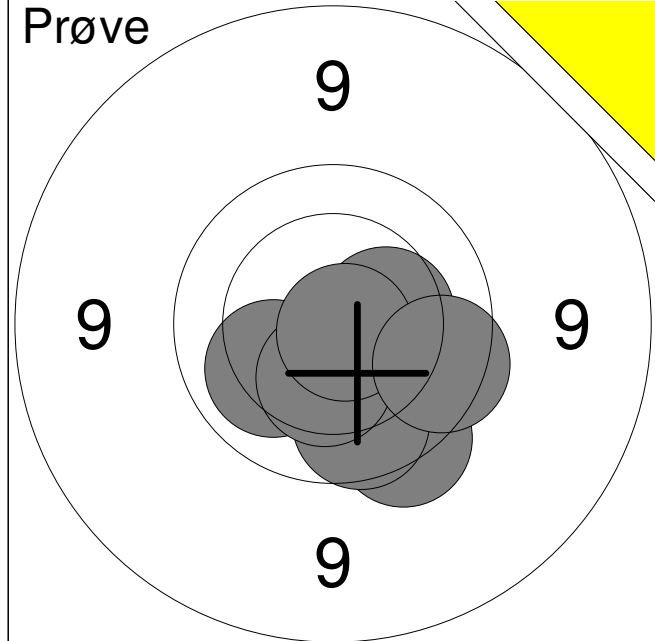

1:	9.7	↘
2:	9.9	↘
3:	10.1	↙
4:	10.4	↘
5:	10.4	→
6:	10.8x	↘
7:	9.8	→
Serie		67 (1x)
Total		0 (0x)

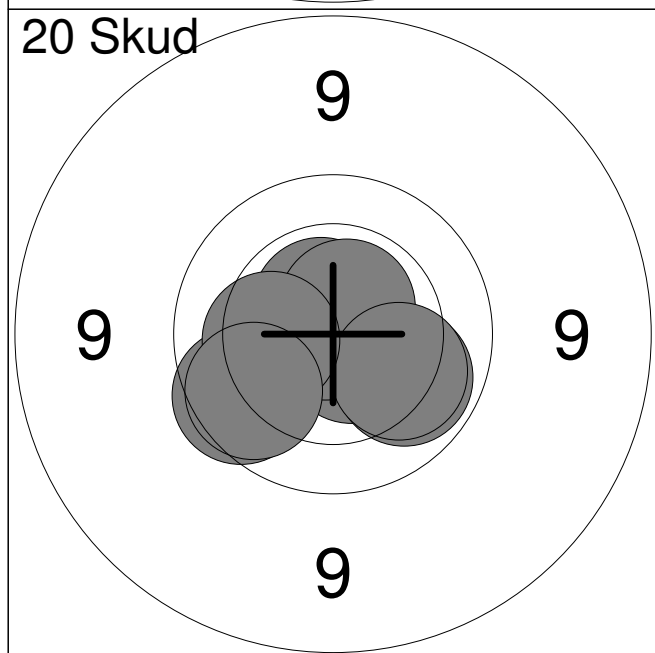

1:	9.8	↙
2:	10.7x	→
3:	10.6x	↘
4:	10.0	↘
5:	10.6x	↗
6:	10.9x	↖
7:	10.6x	↗
8:	10.1	↘
9:	10.3	↙
10:	9.9	↙
Serie		98 (5x)
Total		98 (5x)

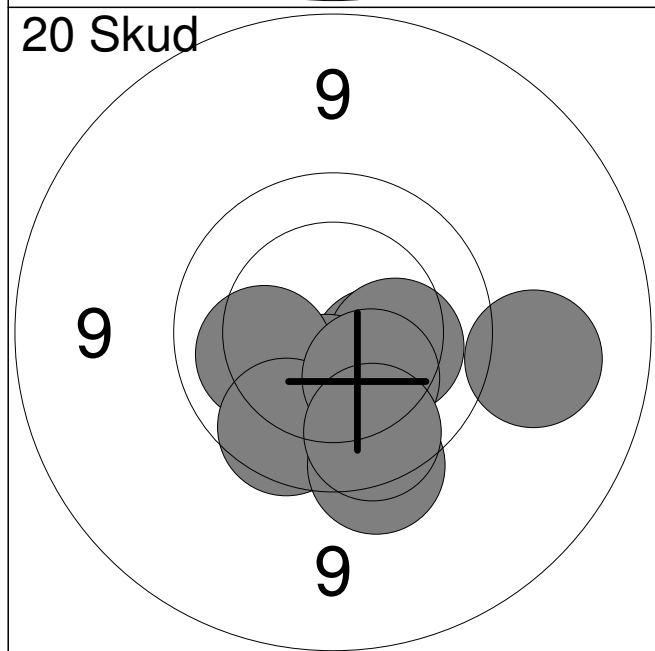

11:	10.1	↘
12:	10.4	↘
13:	10.3	→
14:	10.4	↘
15:	9.2	→
16:	10.2	↙
17:	9.9	↘
18:	10.3	↘
19:	9.6	↘
20:	9.8	↘
Serie		96 (0x)
Total		194 (5x)

Hold 33	Skive 4	Johan Thor Soerensen		
15 meter		Hjørring Skytteforening		MJ2
		Nordjysk mesterskab 2019	Aalborg Skyttekreds	
Prøve		1:	10.4	↙
		2:	9.9	←
		3:	10.1	↘
		4:	10.3	↓
		5:	10.7x	↗
		Serie	49 (1x)	
		Total	0 (0x)	
20 Skud		1:	10.1	↑
		2:	10.1	←
		3:	10.5	↘
		4:	10.6x	↘
		5:	10.2	↘
		6:	9.9	→
		7:	10.6x	↗
		8:	9.7	↘
		9:	10.2	↓
		10:	9.9	→
		Serie	97 (2x)	
		Total	97 (2x)	
20 Skud		11:	10.0	↘
		12:	10.0	↘
		13:	10.4	↘
		14:	9.8	↘
		15:	10.0	↓
		16:	9.7	↘
		17:	9.6	↓
		18:	10.0	↘
		19:	9.9	↘
		20:	10.3	←
		Serie	96 (0x)	
		Total	193 (2x)	

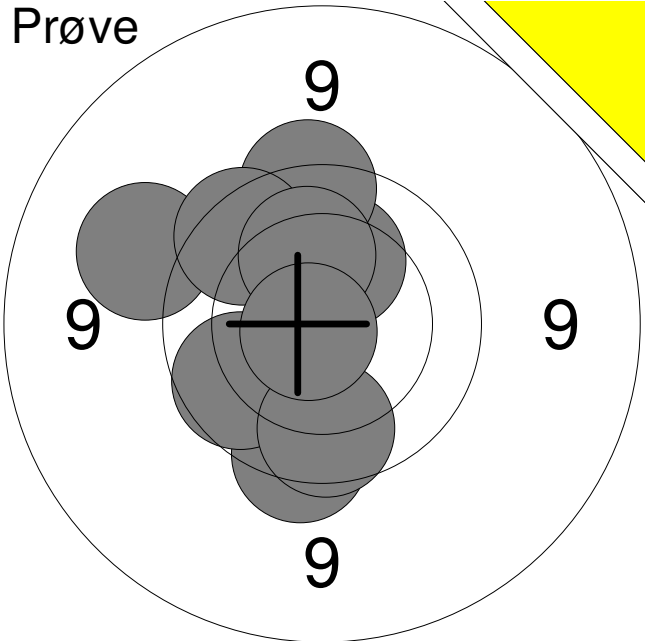
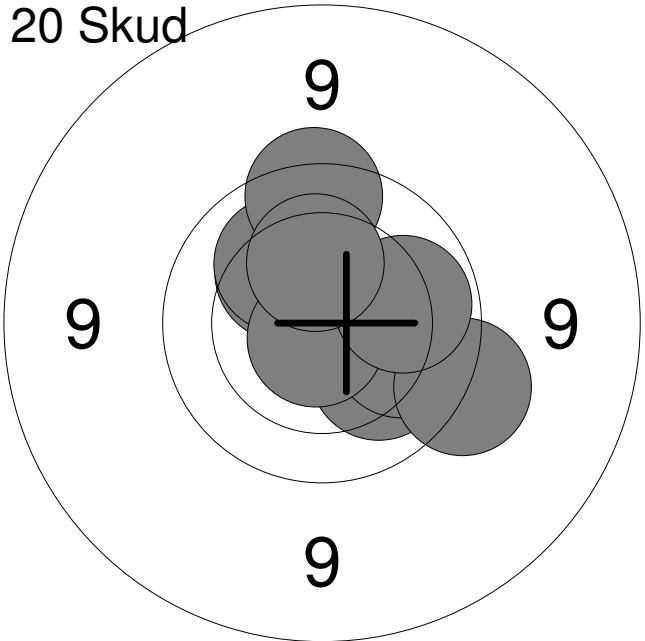
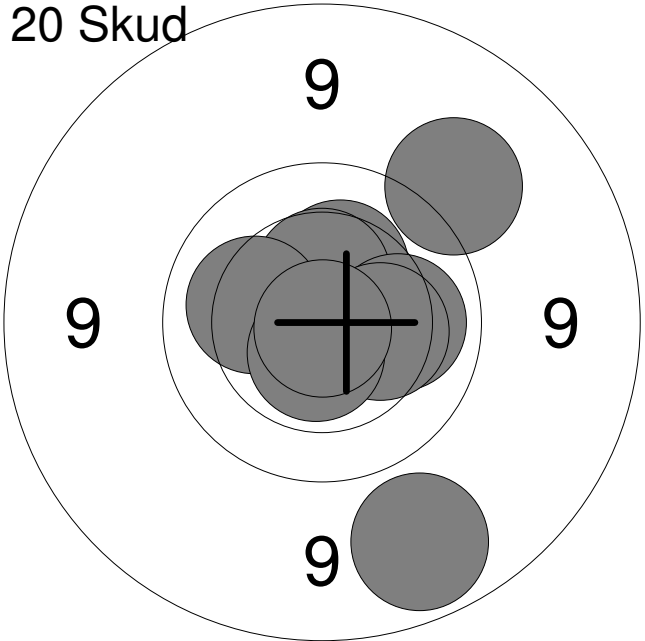
Hold 33	Skive 5	Asmund Mogensen		
15 meter		Hjørring Skytteforening	MJ2	
		Nordjysk mesterskab 2019	Aalborg Skyttekreds	
Prøve 	1:	9.7	↓	
	2:	10.2	↑	
	3:	9.9	↙	
	4:	9.7	↑	
	5:	9.9	↓	
	6:	9.3	↙	
	7:	9.8	↗	
	9:	10.2	↑	
	10:	10.8x	↙	
	Serie		84 (1x)	
	Total		0 (0x)	
20 Skud 	1:	10.1	↘	
	2:	10.2	↗	
	3:	10.2	↗	
	4:	9.7	↑	
	5:	10.0	→	
	6:	10.8x	↗	
	7:	9.6	↘	
	8:	10.8x	↓	
	9:	10.0	→	
	10:	10.3	↑	
	Serie		98 (2x)	
Total		98 (2x)		
20 Skud 	11:	10.3	↑	
	12:	10.7x	→	
	13:	10.4	↑	
	14:	10.1	→	
	15:	10.2	↙	
	16:	10.3	→	
	17:	9.0	↓	
	18:	10.6x	↓	
	19:	9.3	↗	
	20:	10.9x	↓	
	Serie		98 (3x)	
Total		196 (5x)		

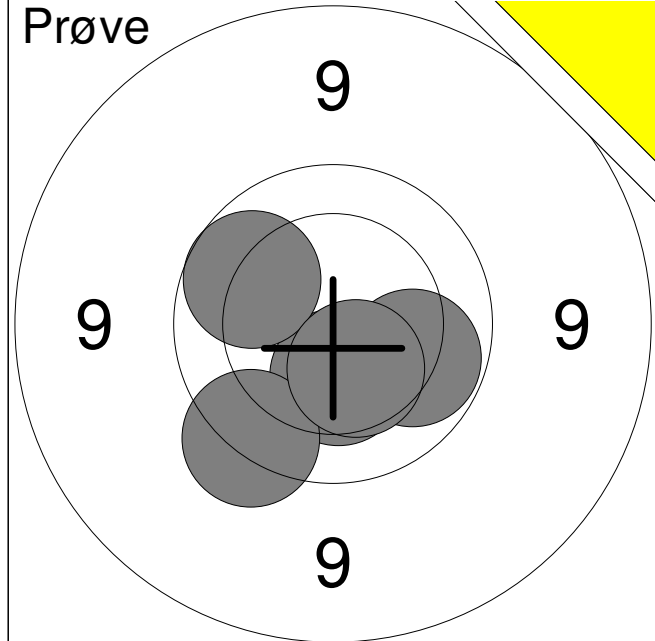

1:	10.4	↓
2:	10.0	→
3:	9.9	↗
4:	9.6	↘
5:	10.4	↘
Serie	48 (0x)	
Total	0 (0x)	

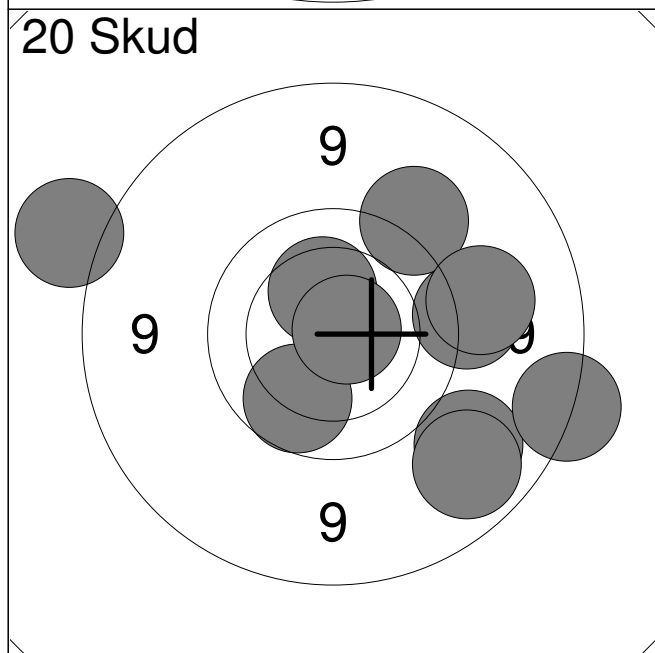

1:	9.4	↗
2:	9.4	→
3:	9.1	↘
4:	10.3	↑
5:	9.0	↘
6:	9.3	→
7:	9.9	↘
8:	8.7	→
9:	8.5	↖
10:	10.8x	→
Serie	90 (1x)	
Total	90 (1x)	

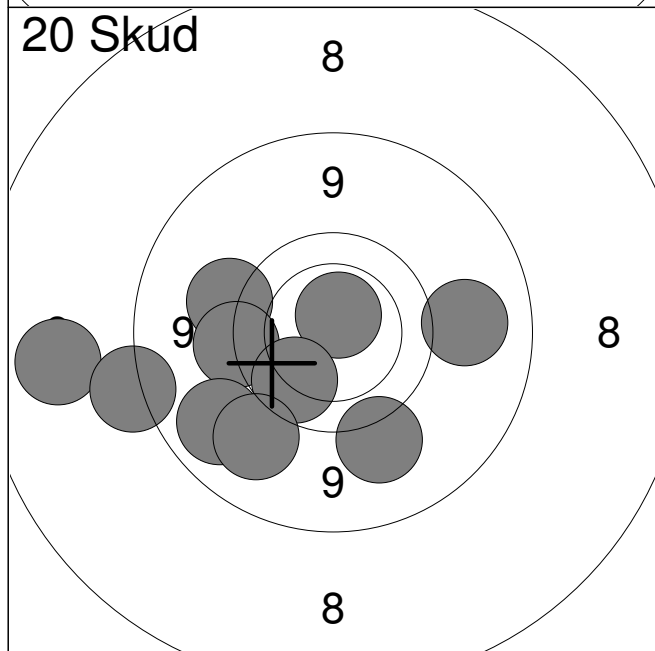

11:	10.6x	↑
12:	9.3	↘
13:	9.2	→
14:	9.4	↖
15:	8.2	↖
16:	8.6	↖
17:	9.5	↖
18:	9.1	↘
19:	9.9	↘
20:	9.2	↘
Serie	89 (1x)	
Total	179 (2x)	

Hold 33	Skive 7	Lucas Pedersen		
15 meter		Frederikshavn Skyttekreds		BK3
		Nordjysk mesterskab 2019	Aalborg Skyttekreds	
Prøve		1:	9.1	↗
		2:	10.5x	↑
		3:	10.0	↗
		4:	9.8	↖
		5:	9.9	↖
		6:	9.8	↗
		7:	9.7	↗
		8:	9.8	↘
		Serie	74 (1x)	
		Total	0 (0x)	
20 Skud		1:	10.8x	↘
		2:	10.6x	↖
		3:	9.8	↗
		4:	9.7	↑
		5:	10.6x	↖
		6:	9.9	↖
		7:	10.6x	↖
		8:	10.7x	↖
		9:	9.9	→
		10:	10.2	→
		Serie	96 (5x)	
		Total	96 (5x)	
20 Skud		11:	10.6x	↗
		12:	9.9	↘
		13:	10.3	↘
		14:	10.4	↖
		15:	9.8	↘
		16:	9.9	↘
		17:	10.5x	↘
		18:	9.9	↖
		19:	10.5x	↖
		20:	9.9	↘
		Serie	95 (3x)	
		Total	191 (8x)	

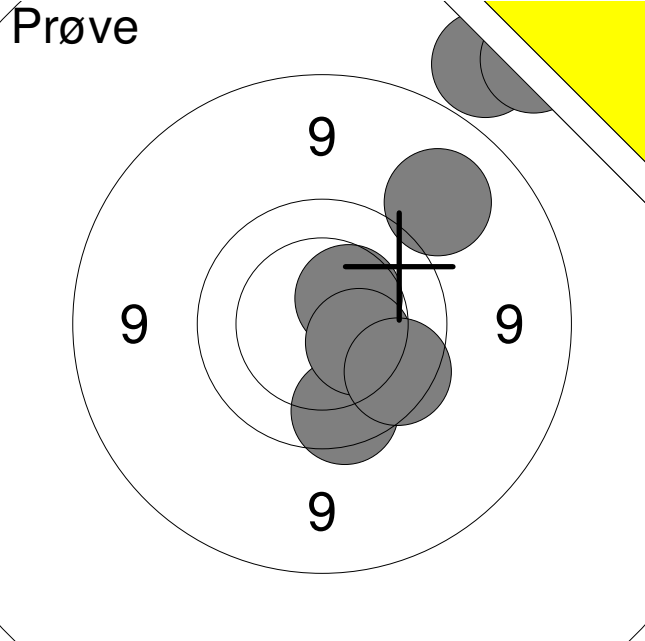
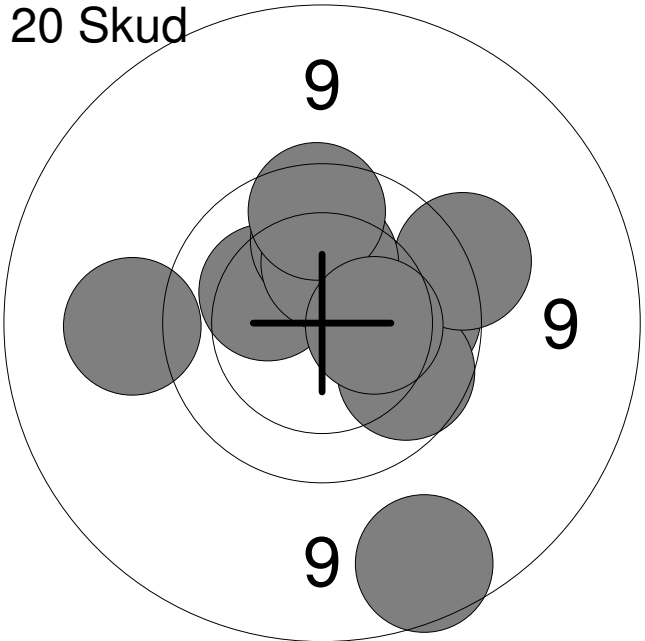
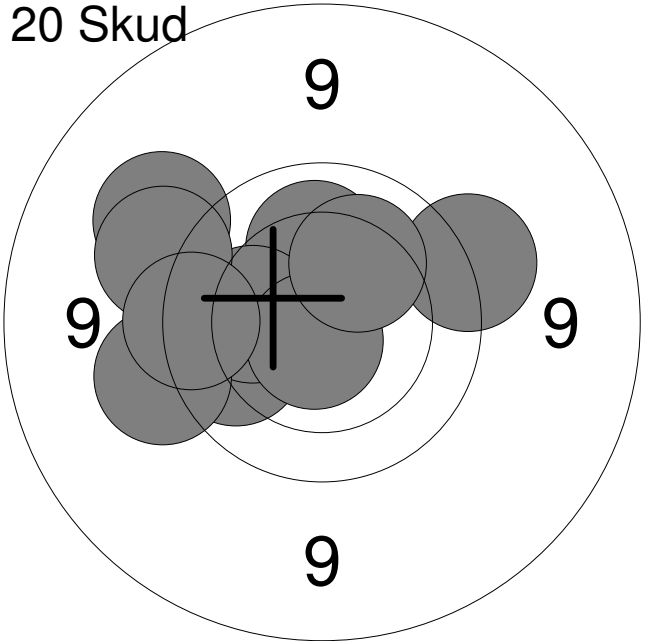
Hold 33	Skive 8	Noah Pedersen		
15 meter		Frederikshavn Skyttekreds		BK3
		Nordjysk mesterskab 2019	Aalborg Skyttekreds	
Prøve 		1: 8.4 ↗		
		2: 8.2 ↗		
		3: 9.2 ↗		
		4: 10.4 ↗		
		5: 9.8 ↓		
		6: 10.4 ↘		
		7: 9.8 ↘		
		Serie	63 (0x)	
		Total	0 (0x)	
20 Skud 		1: 10.0 →		
		2: 10.3 ↖		
		3: 10.0 ↑		
		4: 9.9 ↘		
		5: 9.6 →		
		6: 10.3 ↑		
		7: 8.9 ↓		
		8: 9.8 ↑		
		9: 9.3 ←		
		10: 10.4 →		
		Serie	94 (0x)	
		Total	94 (0x)	
20 Skud 		11: 9.3 ↖		
		12: 10.1 ↑		
		13: 9.9 ←		
		14: 10.2 ←		
		15: 9.5 →		
		16: 10.7x ↓		
		17: 9.4 ↖		
		18: 10.2 ↗		
		19: 9.5 ←		
		20: 9.7 ←		
		Serie	94 (1x)	
		Total	188 (1x)	

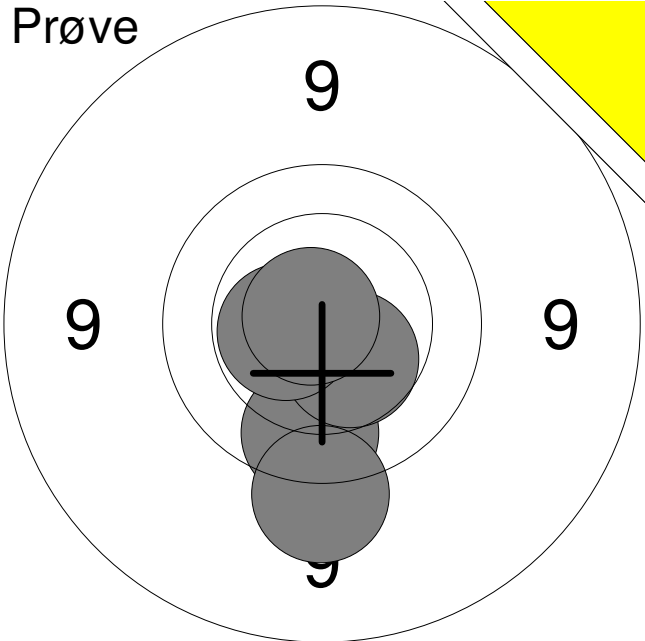
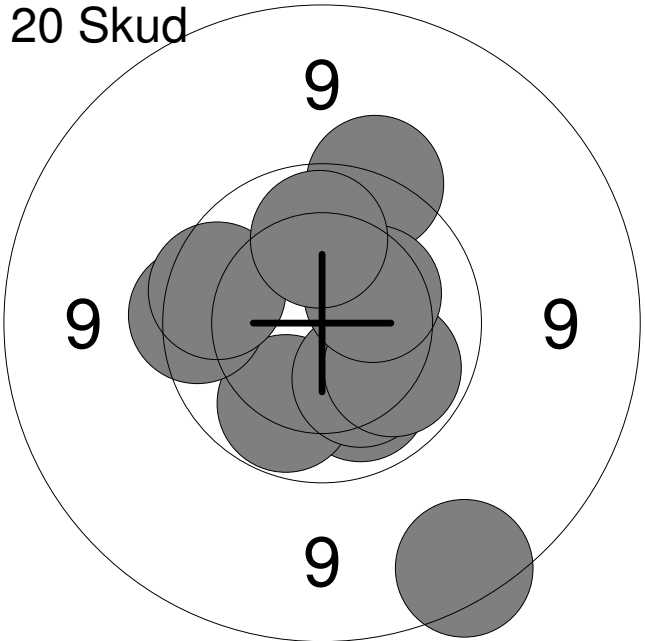
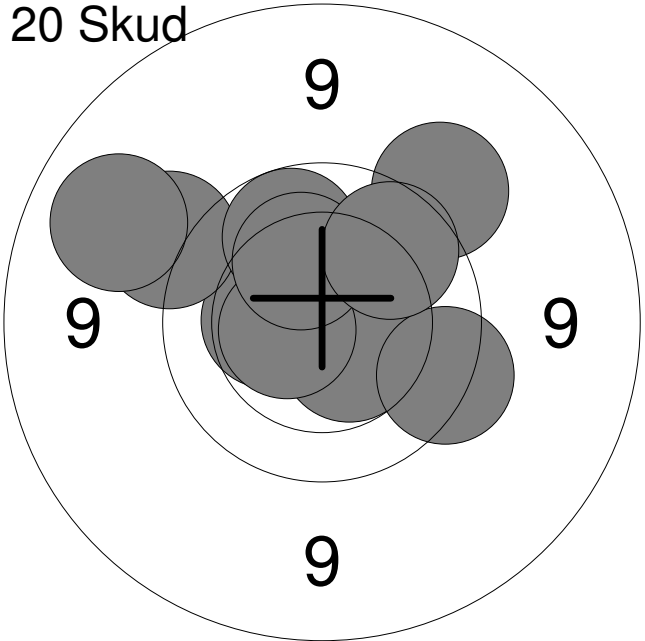
Hold 33	Skive 9	Malthe Marx Moeller_Jensen	
15 meter		Frederikshavn Skyttekreds	BK3
		Nordjysk mesterskab 2019	Aalborg Skyttekreds
Prøve		1: 9.8	↓
		2: 10.5	↘
		3: 10.5x	←
		4: 9.4	↓
		5: 10.8x	↗
		Serie	48 (2x)
		Total	0 (0x)
20 Skud		1: 10.1	↘
		2: 10.0	↘
		3: 10.2	↘
		4: 8.8	↘
		5: 10.0	↘
		6: 9.6	↗
		7: 10.3	↗
		8: 9.7	←
		9: 9.8	←
		10: 10.0	↑
		Serie	95 (0x)
		Total	95 (0x)
20 Skud		11: 10.4	←
		12: 9.4	↗
		13: 10.5	↘
		14: 9.4	↗
		15: 9.9	↗
		16: 9.7	↘
		17: 10.6x	←
		18: 10.2	↗
		19: 9.9	↗
		20: 9.1	←
		Serie	94 (1x)
		Total	189 (1x)

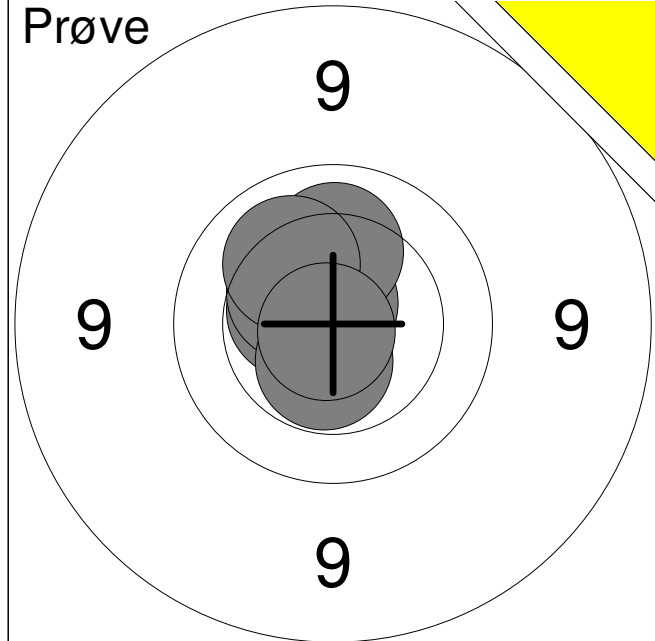

1:	10.5x	↖
2:	10.4	↗
3:	10.7x	↑
4:	10.1	↑
5:	10.1	↗
6:	10.5x	↓
7:	10.8x	↙
Serie		70 (4x)
Total		0 (0x)

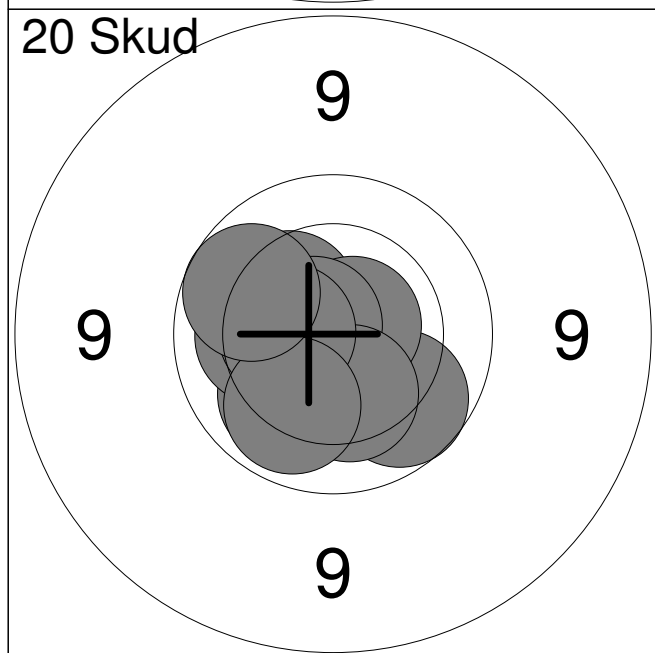

1:	9.9	↘
2:	10.3	↗
3:	10.7x	→
4:	10.7x	↖
5:	10.1	↘
6:	10.3	↓
7:	10.2	←
8:	10.4	←
9:	10.0	↘
10:	9.9	↖
Serie		98 (2x)
Total		98 (2x)

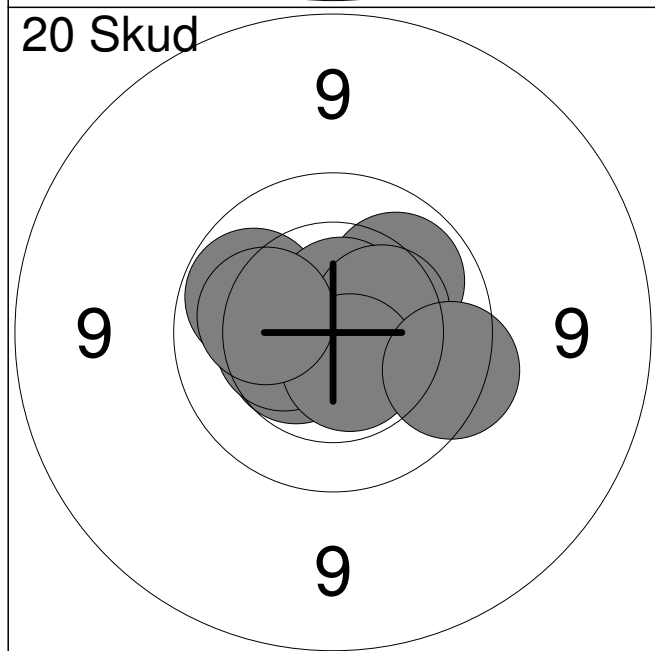

11:	10.0	↖
12:	10.1	↗
13:	10.5	↖
14:	10.8x	↓
15:	10.6x	↑
16:	10.4	←
17:	10.4	→
18:	10.6x	↘
19:	10.2	←
20:	9.7	→
Serie		99 (3x)
Total		197 (5x)

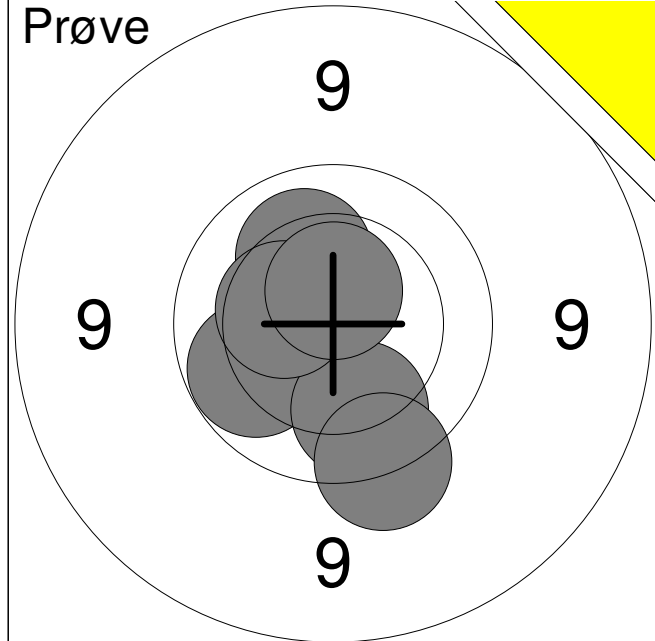

1:	10.4	←
2:	10.7x	↗
3:	10.1	↗
4:	10.0	←
5:	10.0	↓
6:	9.6	↓
7:	10.4	←
8:	10.6x	↑
Serie		79 (2x)
Total		0 (0x)

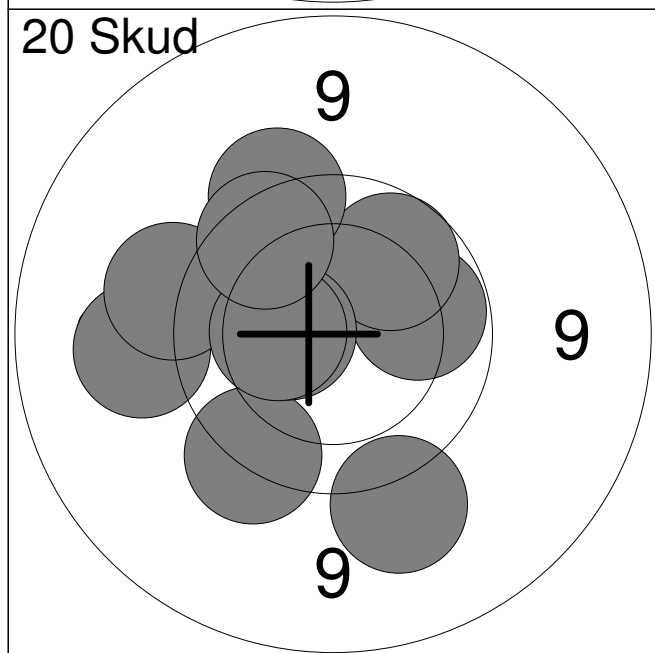

1:	10.0	→
2:	9.9	↗
3:	9.3	←
4:	9.6	↓
5:	10.4	←
6:	9.5	←
7:	10.3	←
8:	9.6	↑
9:	9.8	↗
10:	9.4	↓
Serie		93 (0x)
Total		93 (0x)

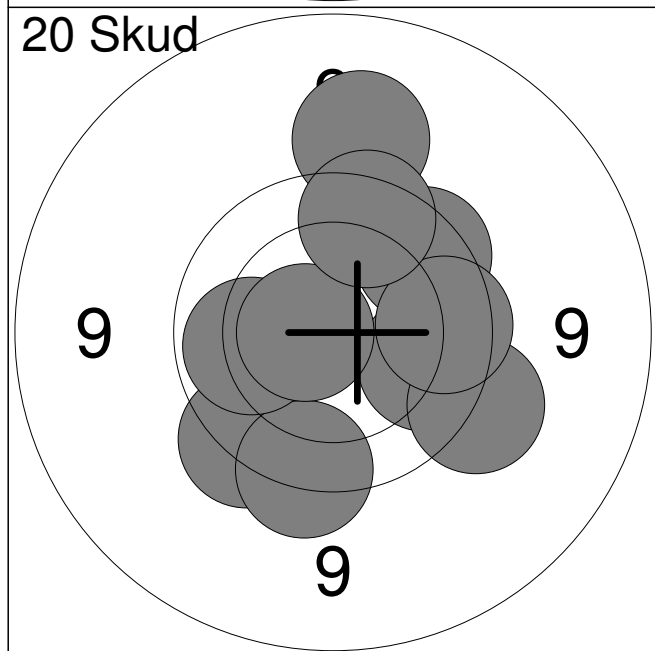

11:	9.9	→
12:	9.7	↓
13:	9.6	↓
14:	9.8	↗
15:	9.5	↘
16:	9.8	→
17:	10.0	←
18:	10.6x	←
19:	9.3	↑
20:	9.8	↑
Serie		92 (1x)
Total		185 (1x)

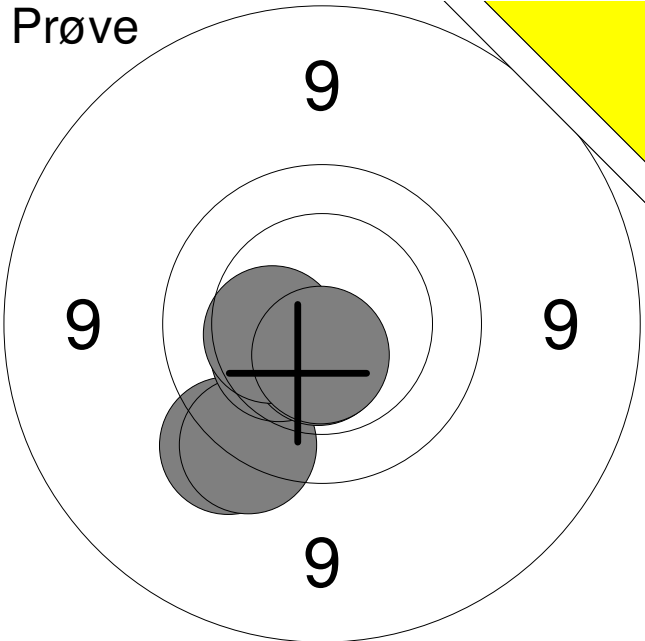
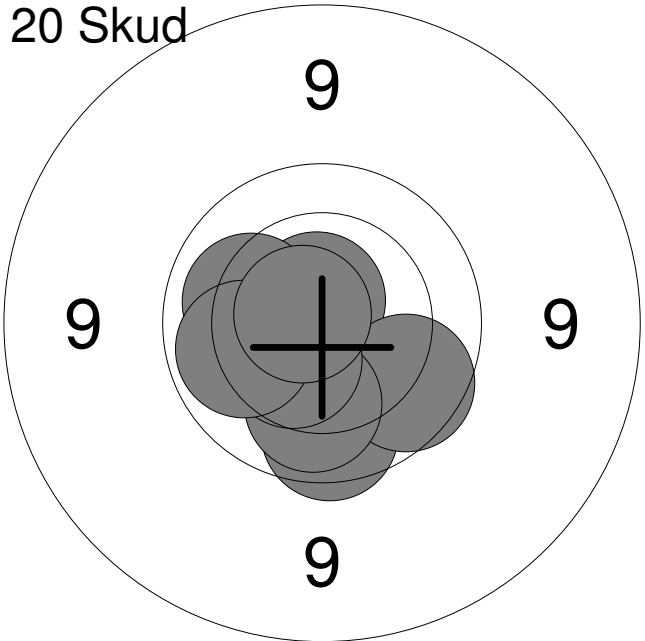
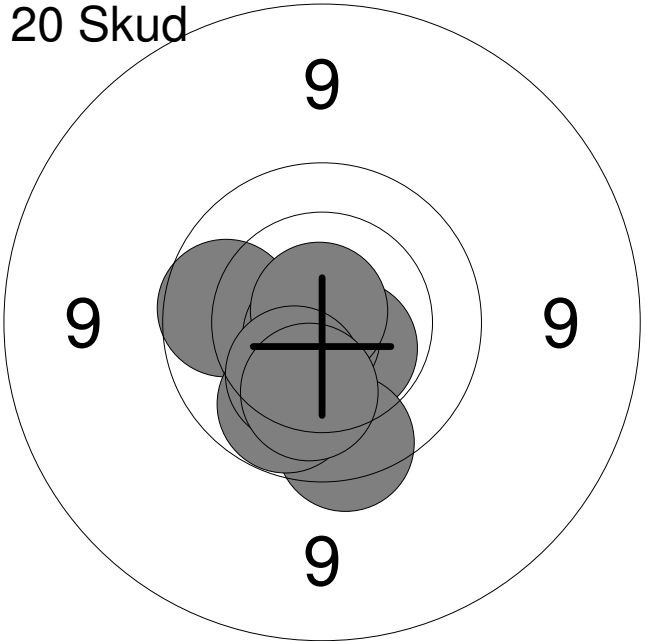
Hold 33	Skive 12	Elias Erbs		
15 meter		Frederikshavn Skyttekreds		BK2
		Nordjysk mesterskab 2019	Aalborg Skyttekreds	
Prøve 		1: 9.6 ↙ 2: 9.6 ↘ 3: 10.4 ↙ 4: 10.6x ↓ 5: 10.4 ← 6: 10.6x ↓		
		Serie		58 (2x)
		Total		0 (0x)
20 Skud 		1: 10.7x ↓ 2: 10.2 ↓ 3: 9.8 ↓ 4: 10.7x ↑ 5: 9.9 ↘ 6: 10.1 ↓ 7: 10.1 ← 8: 10.4 ↘ 9: 10.0 ← 10: 10.7x ↙		
		Serie		98 (3x)
		Total		98 (3x)
20 Skud 		11: 10.4 ↓ 12: 10.5x ↘ 13: 9.7 ↓ 14: 9.9 ← 15: 10.2 ↓ 16: 10.8x ↘ 17: 10.0 ↓ 18: 10.8x ↑ 19: 10.3 ↘ 20: 10.2 ↓		
		Serie		98 (3x)
		Total		196 (6x)

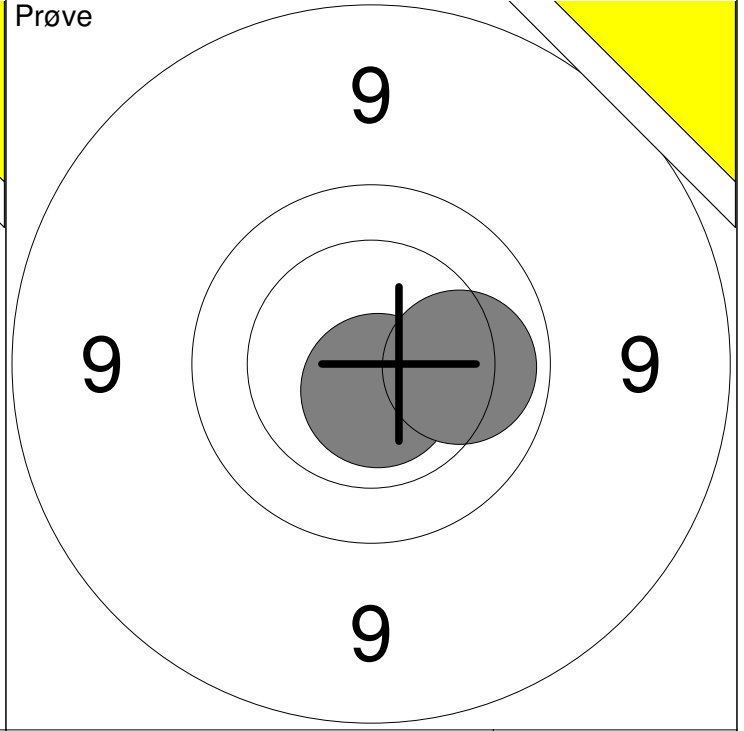
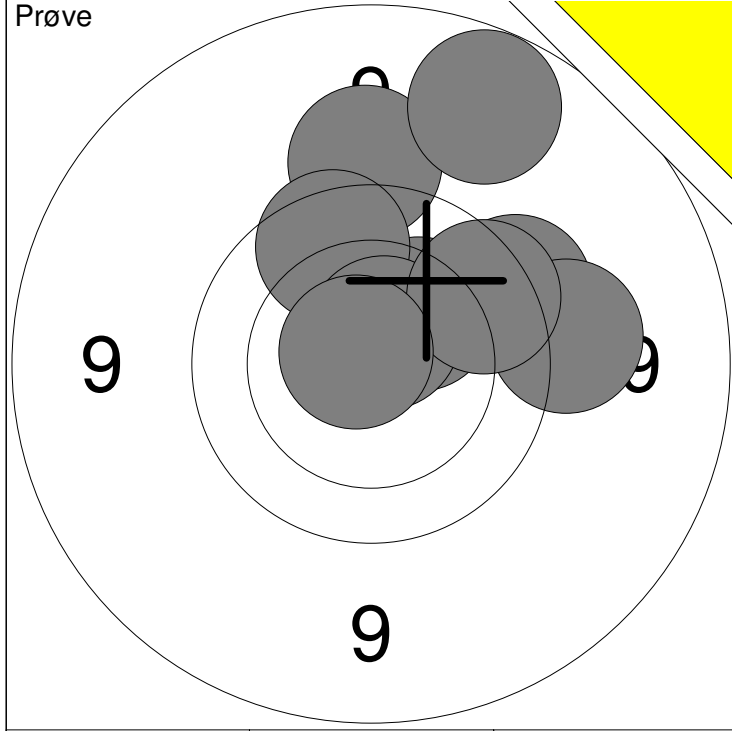

1: 9.4 ↑	7: 9.4 →	Serie	84 (2x)
2: 9.0 ↗	8: 10.6x ↗		
3: 10.3 ↗	9: 9.8 ↗	Total	0 (0x)
4: 9.8 ↗	10: 10.8x ↖		
6: 9.6 ↗			

11: 10.7x ↓	Serie	20 (1x)
12: 10.1 →		
	Total	0 (0x)

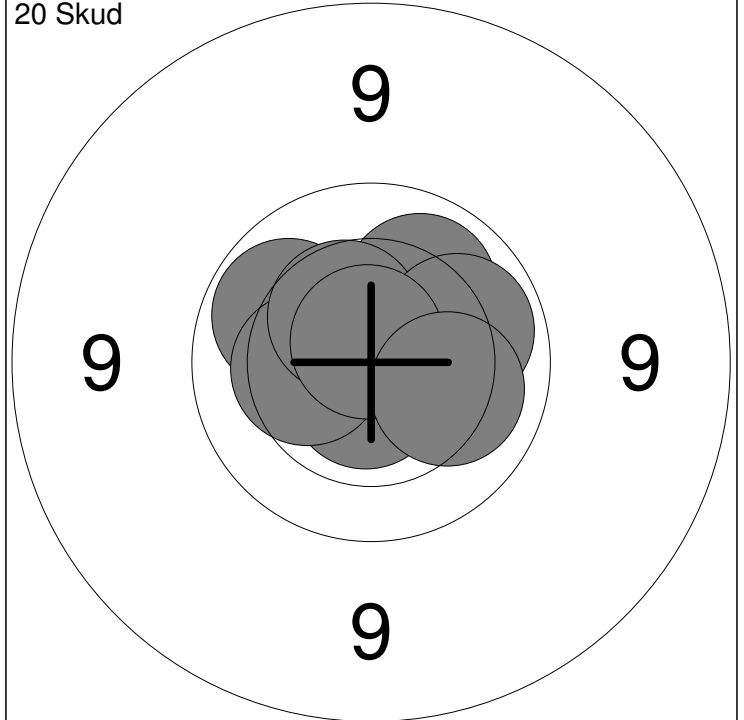
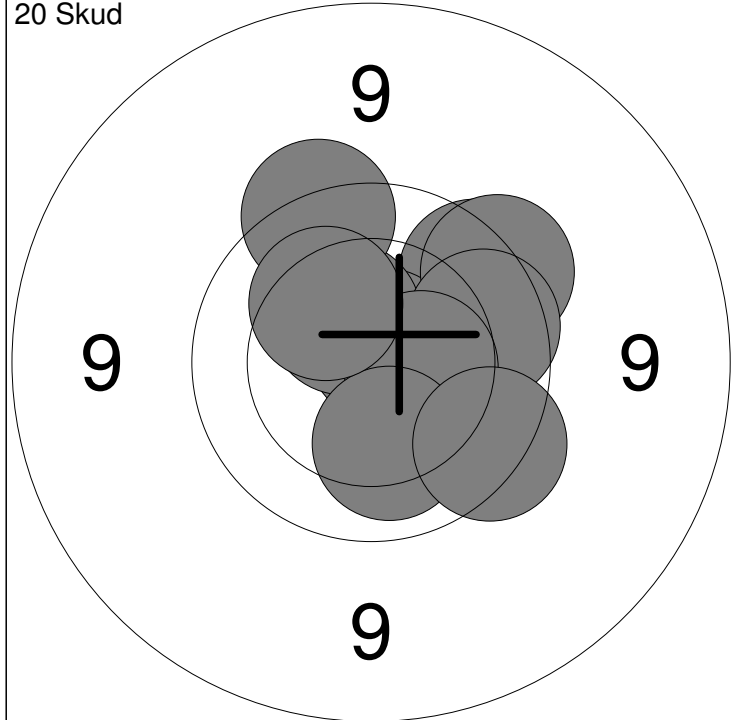

1: 9.8 ↗	6: 9.7 ↗	Serie	95 (1x)
2: 10.7x ↗	7: 10.5 →		
3: 10.4 ↗	8: 10.1 ↓	Total	95 (1x)
4: 9.7 ↗	9: 9.7 ↓		
5: 9.9 ↗	10: 10.2 ↗		

11: 10.7x ↓	16: 10.3 ←	Serie	100 (4x)
12: 10.7x ↗	17: 10.4 ↗		
13: 10.5x ↖	18: 10.0 →	Total	195 (5x)
14: 10.1 ↗	19: 10.7x ↗		
15: 10.0 ↖	20: 10.2 →		

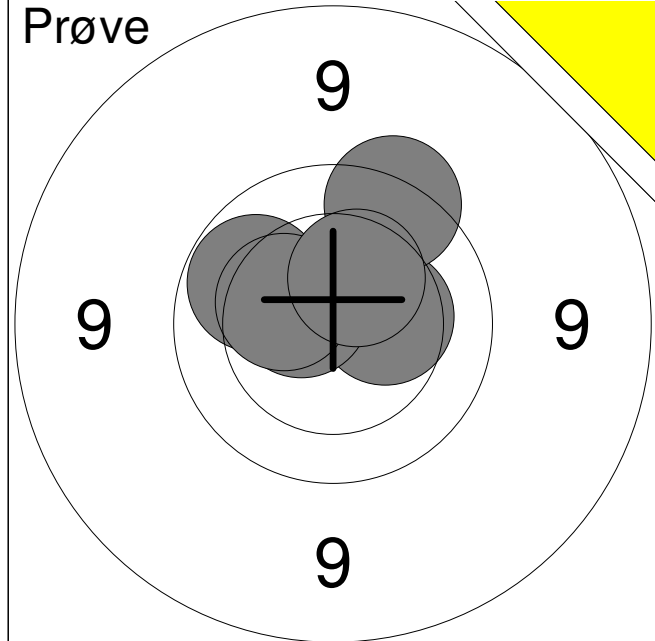

1:	10.4	→
2:	9.7	↗
3:	10.0	↖
4:	10.6x	↖
5:	10.4	↖
6:	10.4	↗
Serie		59 (1x)
Total		0 (0x)

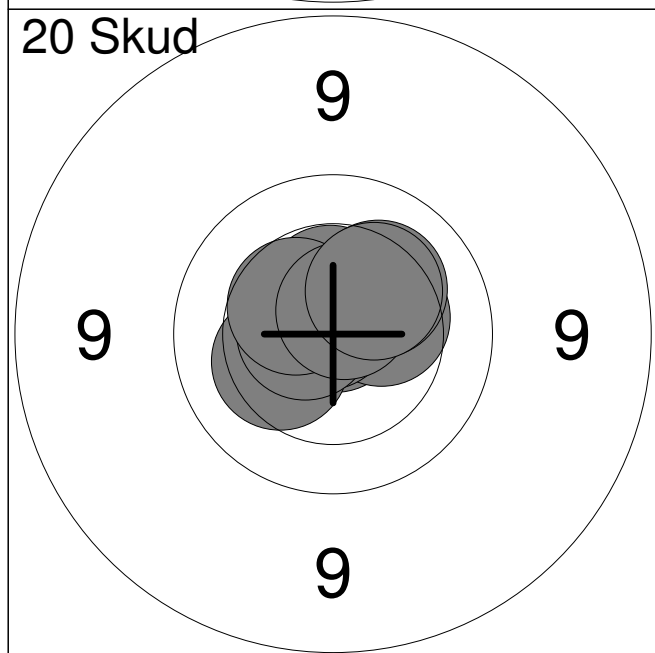

1:	10.8x	↑
2:	10.4	→
3:	10.8x	↖
4:	10.3	↖
5:	10.5x	↑
6:	10.2	↗
7:	10.6x	←
8:	10.4	↖
9:	10.7x	↗
10:	10.3	↗
Serie		100 (5x)
Total		100 (5x)

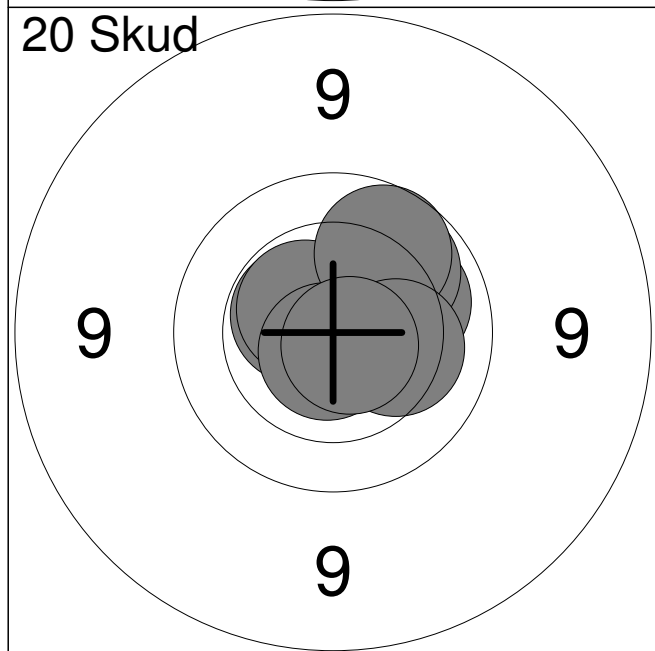

11:	10.8x	↘
12:	10.7x	→
13:	10.1	→
14:	10.0	↗
15:	10.5x	↖
16:	10.5x	↖
17:	10.7x	↓
18:	9.9	↗
19:	10.2	→
20:	10.7x	↘
Serie		99 (6x)
Total		199 (11x)

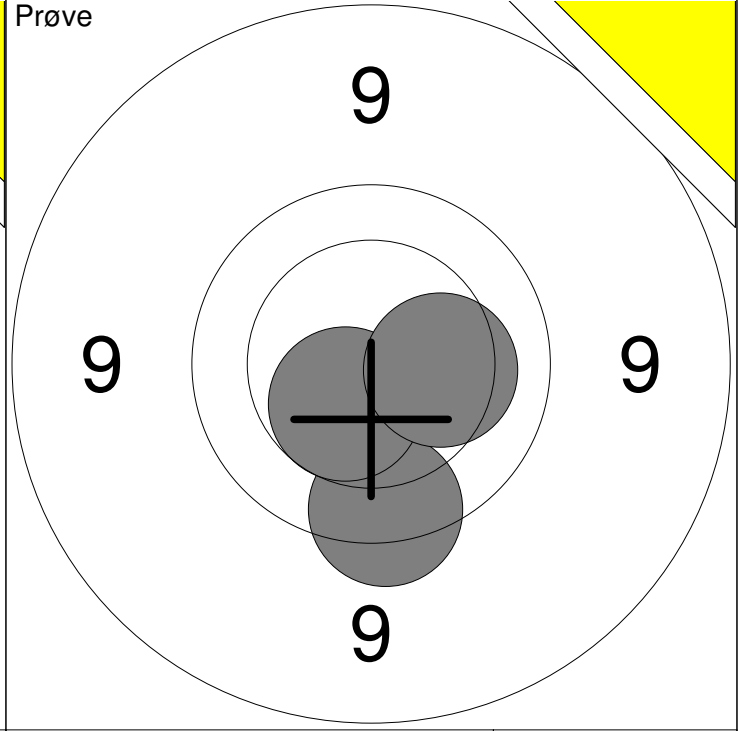
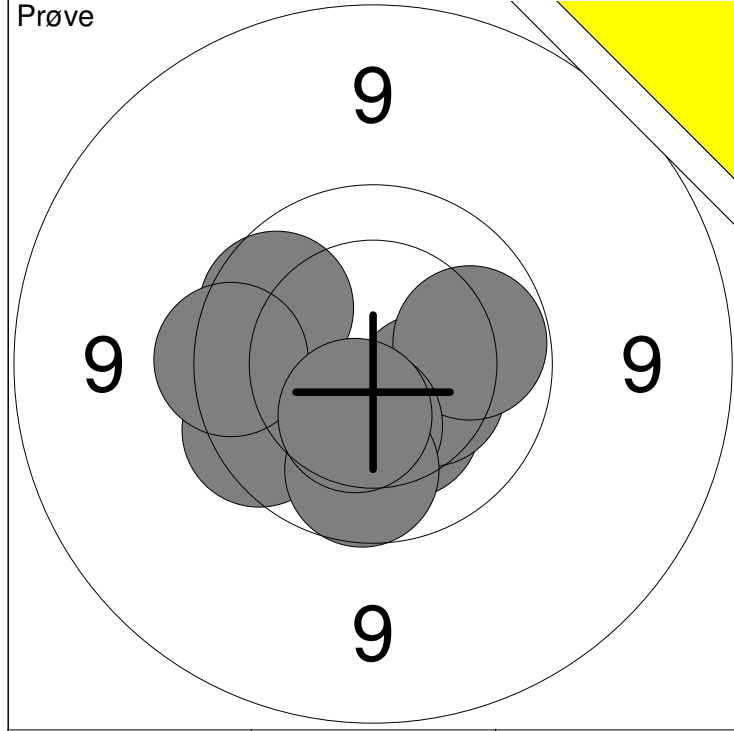

1: 10.3 ↘	7: 9.7 ←	Serie	86 (0x)
2: 9.8 ↙	8: 10.3 ↓		
4: 10.4 ↘	9: 9.9 ↓	Total	0 (0x)
5: 10.0 →	10: 10.4 ↓		
6: 9.9 ↗			

11: 9.7 ↓	Serie	29 (0x)
12: 10.5 ↘		
13: 10.3 →	Total	0 (0x)

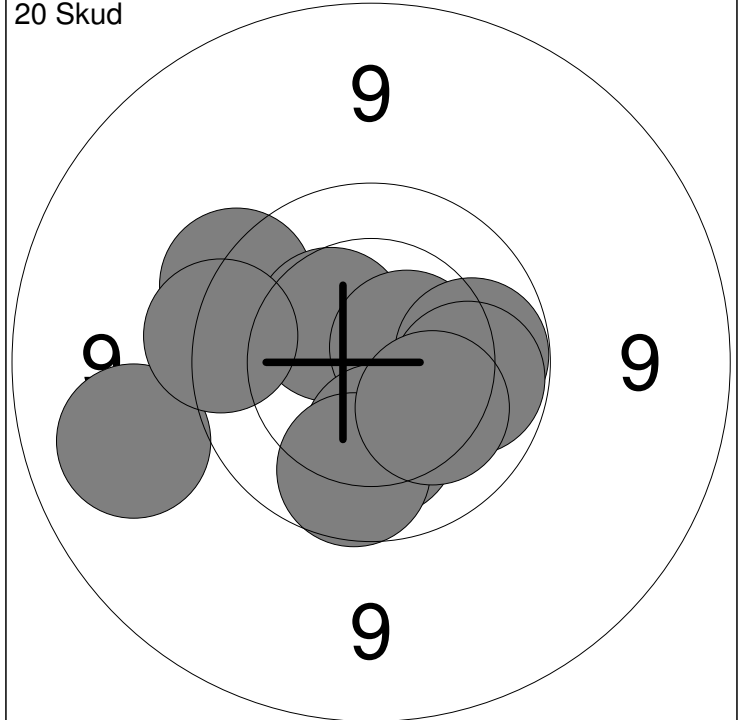
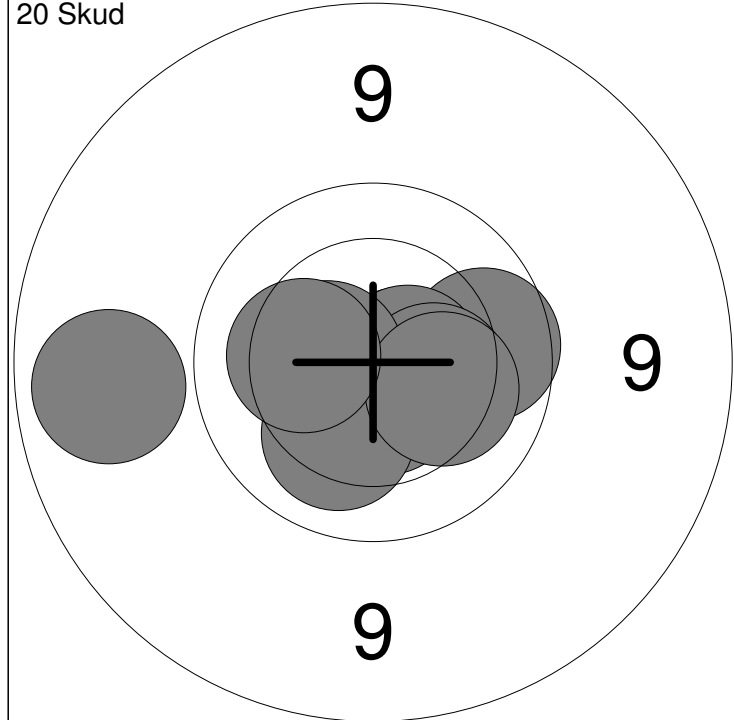

1: 10.7x →	6: 10.3 →	Serie	98 (4x)
2: 9.0 ←	7: 10.5x ←		
3: 10.6x ↓	8: 10.2 ↓	Total	98 (4x)
4: 9.9 →	9: 10.2 →		
5: 10.6x →	10: 10.3 ←		

11: 9.7 ↙	16: 10.0 →	Serie	96 (1x)
12: 10.4 ↙	17: 9.1 ←		
13: 10.6x →	18: 10.0 →	Total	194 (5x)
14: 10.2 ↓	19: 10.2 ↘		
15: 9.9 ↓	20: 9.7 ←		

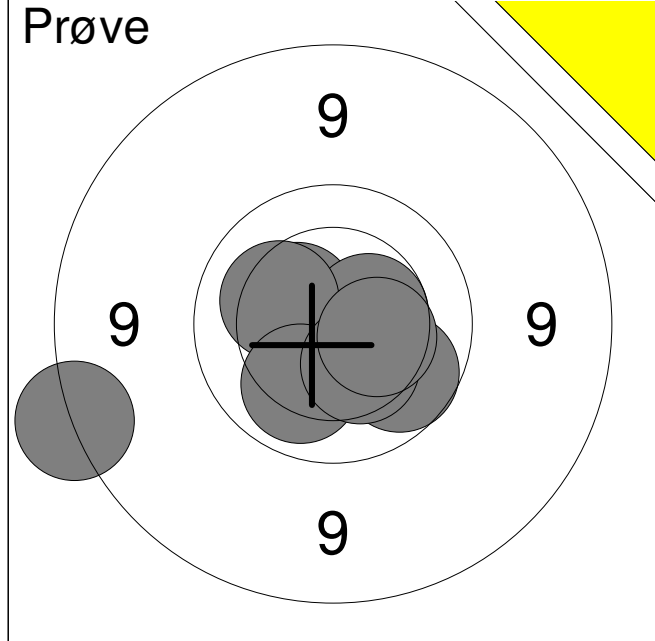

1:	8.7	←
2:	10.6x	↓
3:	10.4	↗
4:	10.4	↓
5:	9.9	↘
6:	10.5	→
7:	10.2	←
8:	10.1	↓
9:	10.3	↘
10:	10.4	→
Serie		97 (1x)
Total		0 (0x)

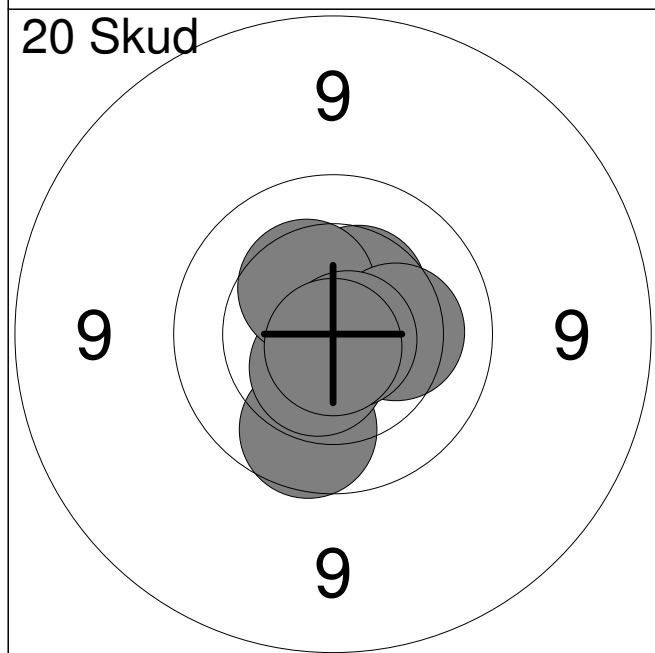

1:	9.9	↓
2:	10.8x	→
3:	10.8x	↓
4:	10.7x	↗
5:	10.5x	↓
6:	10.4	↗
7:	10.4	↗
8:	10.3	→
9:	10.8x	→
10:	10.8x	↓
Serie		99 (6x)
Total		99 (6x)

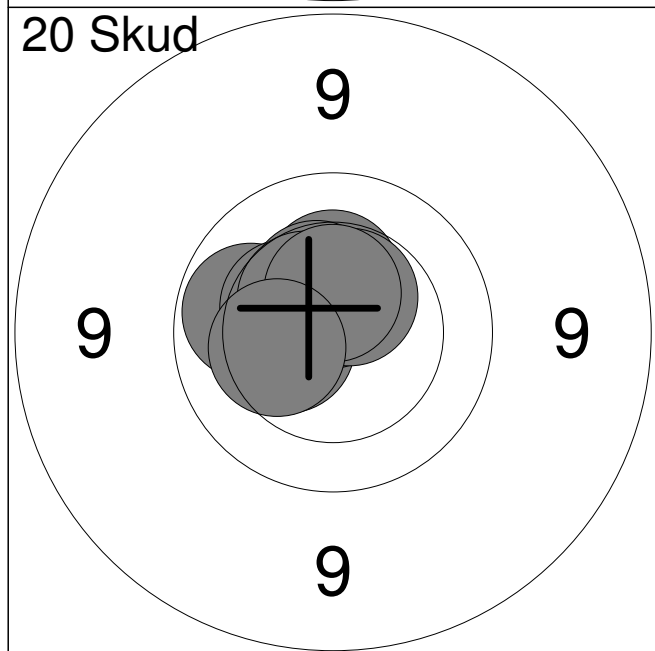

11:	10.0	←
12:	10.4	↑
13:	10.4	←
14:	10.4	↖
15:	10.6x	↑
16:	10.4	↗
17:	10.5x	↗
18:	10.5	↖
19:	10.5x	↑
20:	10.3	←
Serie		100 (3x)
Total		199 (9x)

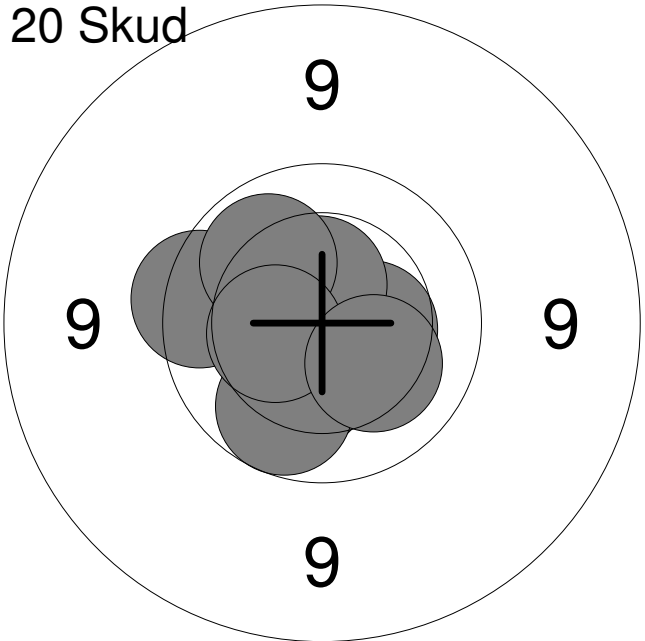
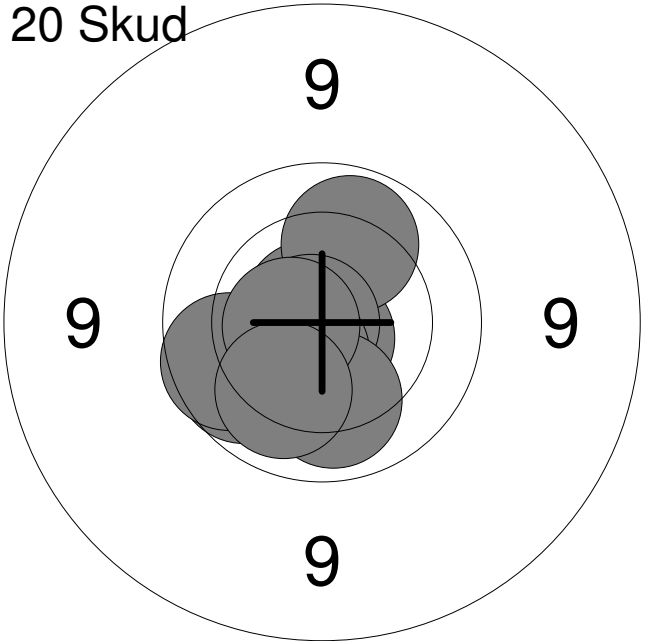
Hold 34	Skive 5	Josefine Frydkaer	
15 meter		Frederikshavn Skyttekreds	BK3
		Nordjysk mesterskab 2019	Aalborg Skyttekreds
Prøve 	1:	9.8	↗
	2:	10.7x	→
	3:	9.6	↘
	4:	10.2	←
	5:	10.6x	↑
	6:	10.0	↙
	7:	10.0	↘
	8:	10.6x	↑
	9:	10.4	↘
	Serie		88 (3x)
Total		0 (0x)	
20 Skud 	1:	10.3	↘
	2:	10.6x	↘
	3:	10.7x	↙
	4:	10.4	→
	5:	9.9	↘
	6:	10.5x	↑
	7:	9.7	←
	8:	10.1	↗
	9:	10.4	←
	10:	10.2	↘
Serie		98 (3x)	
Total		98 (3x)	
20 Skud 	11:	9.9	↙
	12:	10.8x	↗
	13:	10.8x	↘
	14:	10.0	↗
	15:	10.8x	←
	16:	10.5x	↘
	17:	10.1	↘
	18:	9.9	←
	19:	10.6x	←
	20:	10.1	↘
Serie		98 (5x)	
Total		196 (8x)	

Hold 34	Skive 6	
-------------------	-------------------	--

15 meter		
----------	--	--

Nordjysk mesterskab 2019	Aalborg Skyttekreds
--------------------------	---------------------

Prøve

	Serie	0 (0x)
	Total	0 (0x)

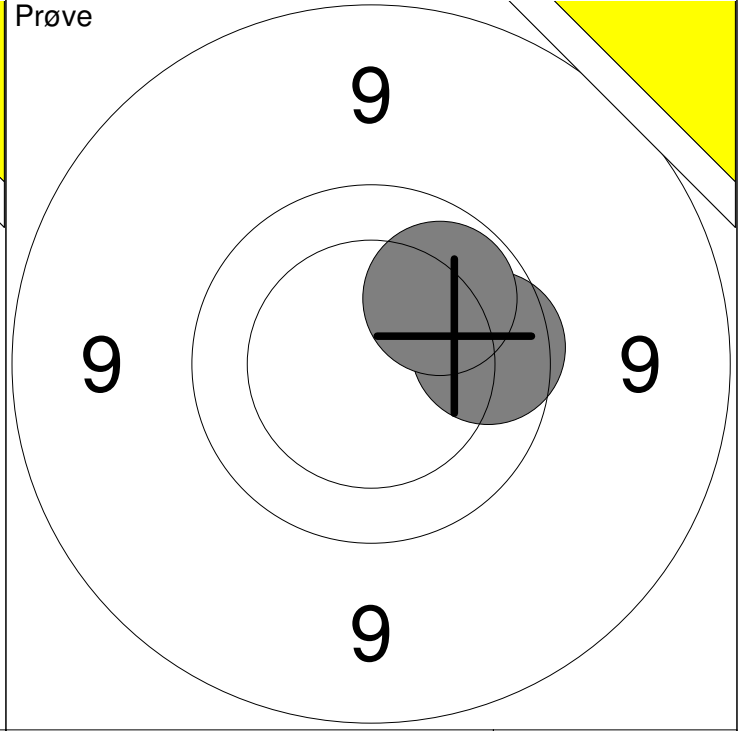
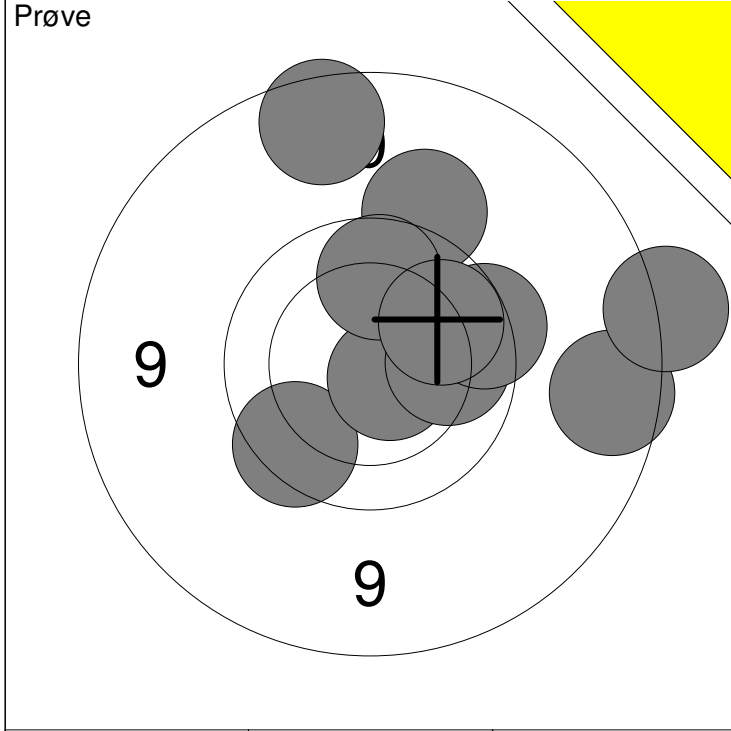

1: 9.8 ↙	6: 9.7 →	Serie	90 (1x)
2: 9.4 ↑	7: 9.9 ↑		
3: 8.9 ↑	8: 8.9 →	Total	0 (0x)
4: 10.7x ↘	9: 8.6 →		
5: 10.0 →	10: 10.0 ↗		

11: 9.9 →	Serie	19 (0x)
12: 10.0 ↗		
	Total	0 (0x)

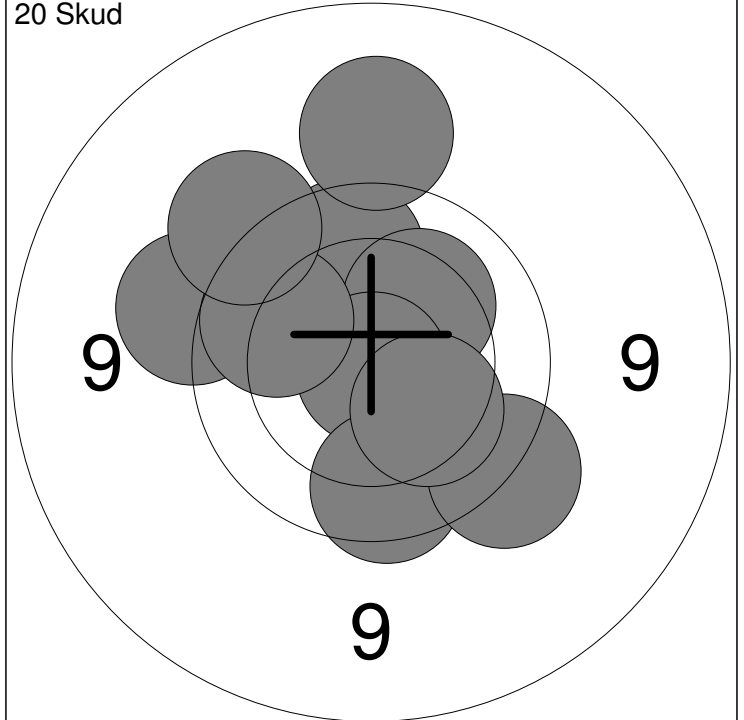
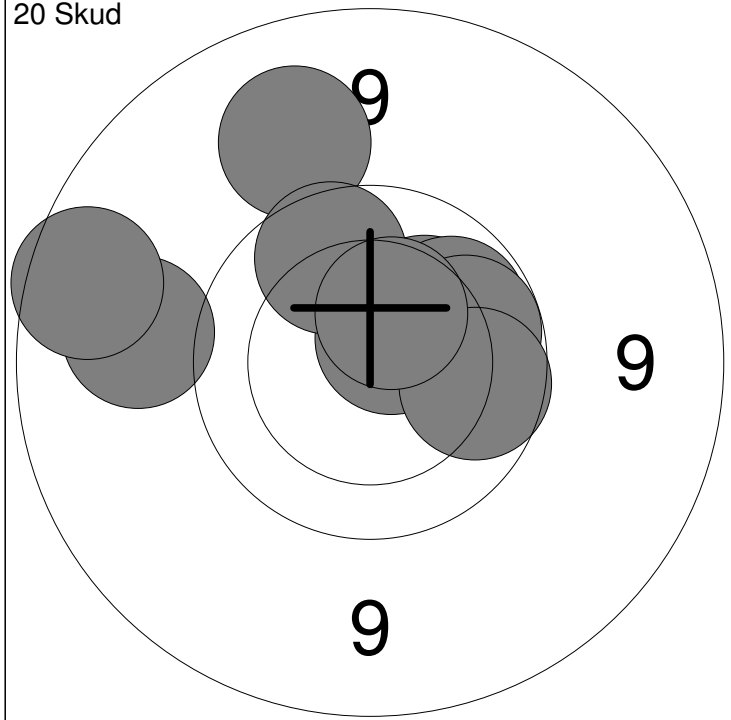

1: 10.2 ↗	6: 10.0 →	Serie	94 (1x)
2: 9.2 ↑	7: 9.9 →		
3: 10.0 ↗	8: 9.2 ←	Total	94 (1x)
4: 10.6x ↗	9: 8.9 ←		
5: 9.9 ↑	10: 10.4 ↑		

11: 9.9 ↑	16: 9.9 ←	Serie	93 (1x)
12: 10.2 ↗	17: 9.6 ↘		
13: 9.5 ←	18: 10.2 ↘	Total	187 (2x)
14: 10.9x ↓	19: 9.2 ↑		
15: 9.8 ↓	20: 9.5 ↖		

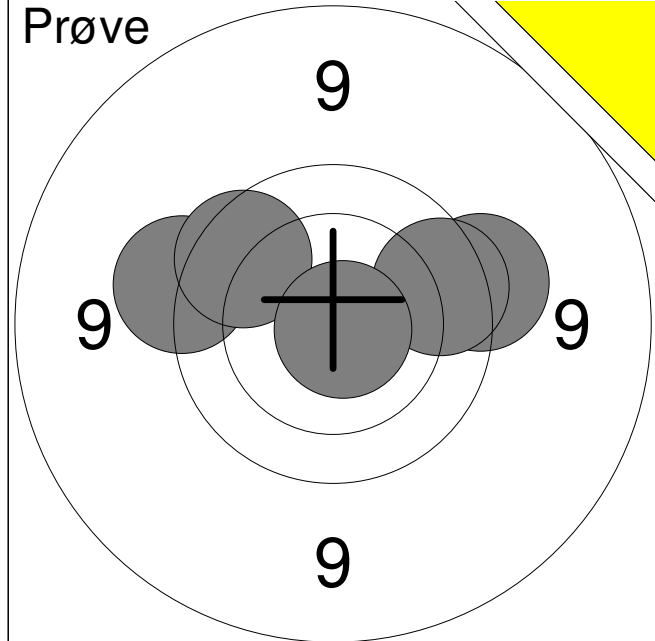

1:	9.5	←
2:	9.6	→
3:	9.8	↗
4:	9.8	→
5:	10.8x	↘
Serie		46 (1x)
Total		0 (0x)

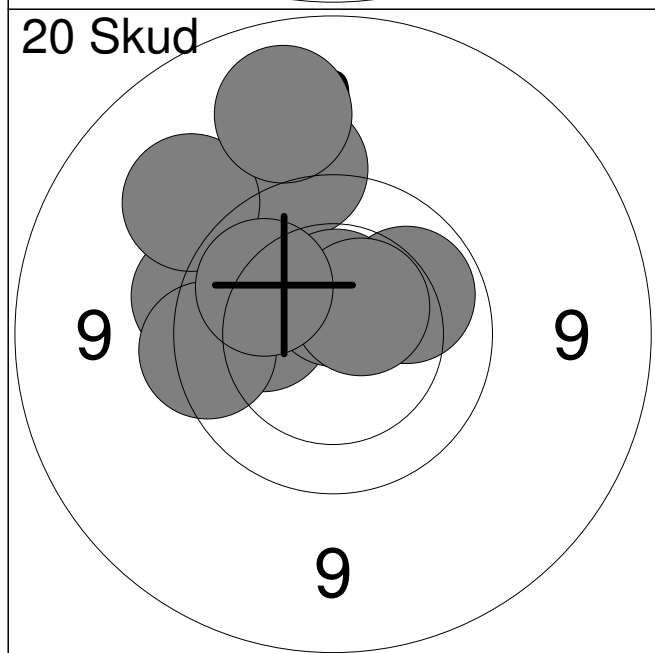

1:	9.7	←
2:	9.5	↑
3:	10.0	↗
4:	9.3	↗
5:	10.2	←
6:	10.5x	↑
7:	9.7	←
8:	10.5x	↗
9:	9.1	↑
10:	10.0	↗
Serie		95 (2x)
Total		95 (2x)

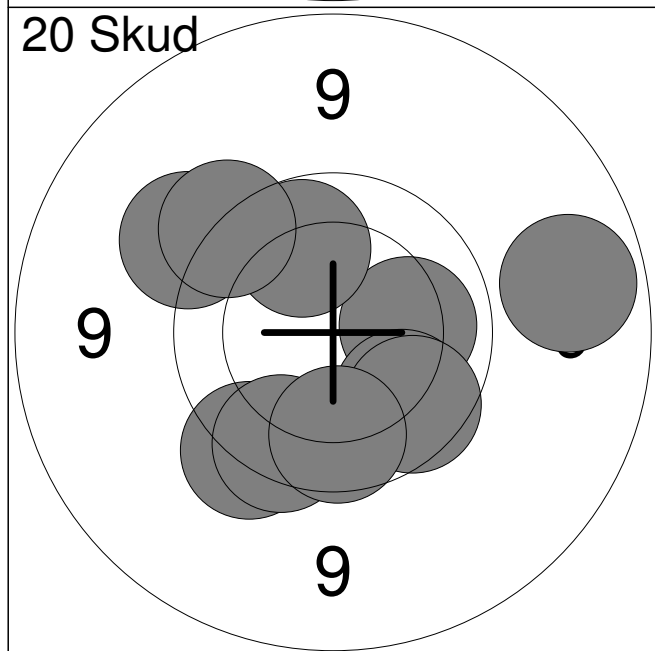

11:	10.1	→
12:	10.0	↑
13:	9.9	↘
14:	9.6	↘
15:	9.8	↘
16:	9.7	↘
17:	9.9	↓
18:	9.4	↗
19:	9.6	↗
20:	9.0	→
Serie		92 (0x)
Total		187 (2x)

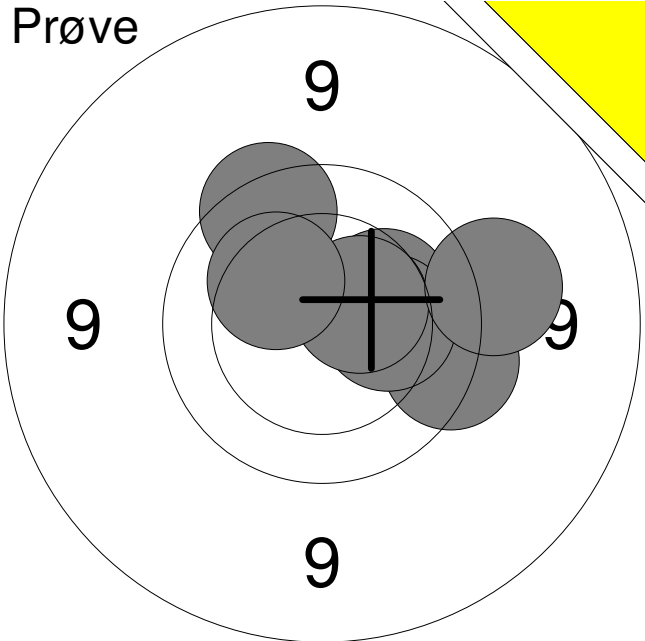
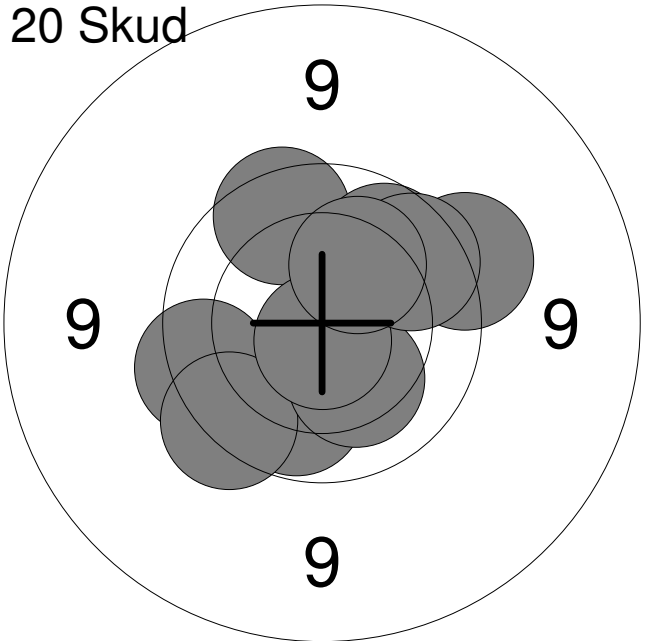
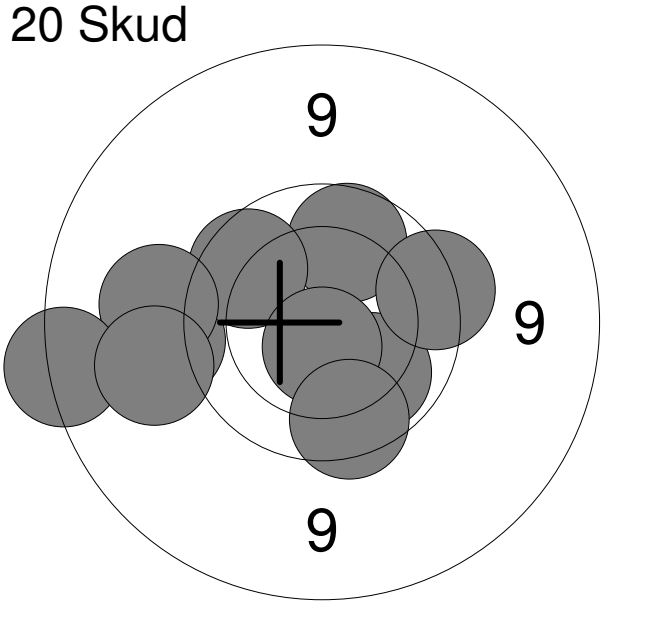
Hold 34	Skive 9	Malthe Andersen		
15 meter		Aalborg Skyttekreds		J2
		Nordjysk mesterskab 2019	Aalborg Skyttekreds	
Prøve		1:	10.2	➔
		2:	9.7	➔
		3:	10.2	➔
		4:	10.5	➔
		5:	9.4	➔
		6:	9.7	↗
		7:	10.3	↗
		Serie	67 (0x)	
		Total	0 (0x)	
20 Skud		1:	10.0	↓
		2:	9.7	←
		3:	9.8	↗
		4:	9.7	↙
		5:	10.2	↓
		6:	10.8x	↓
		7:	9.9	↗
		8:	9.5	➔
		9:	9.8	↗
		10:	10.2	↗
		Serie	94 (1x)	
		Total	94 (1x)	
20 Skud		11:	9.9	↗
		12:	9.4	←
		13:	10.1	↙
		14:	9.9	↗
		15:	9.3	←
		16:	8.7	←
		17:	10.6x	↓
		18:	9.8	↓
		19:	9.7	➔
		20:	9.3	←
		Serie	91 (1x)	
		Total	185 (2x)	

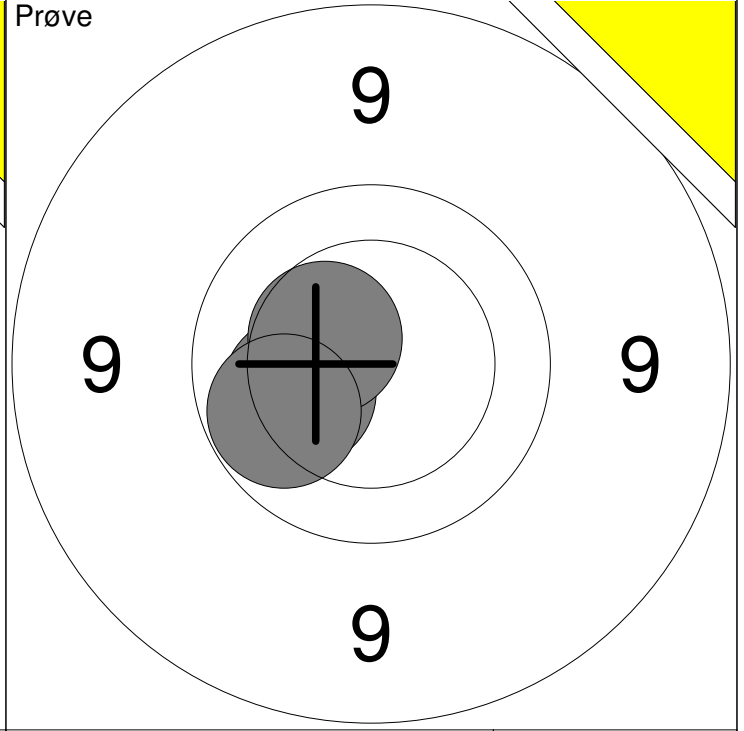
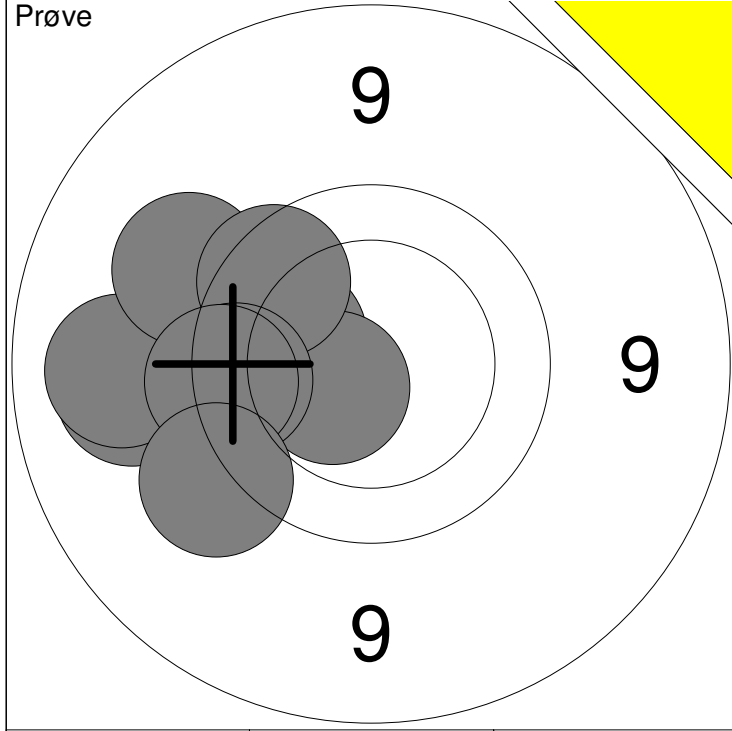

1: 9.6 ←	6: 9.4 ↖	Serie	92 (1x)
2: 10.1 ↖	7: 9.8 ↗		
3: 9.2 ←	8: 9.8 ←	Total	0 (0x)
4: 9.1 ←	9: 9.7 ←		
5: 10.5x ↖	10: 9.4 ↖		

11: 10.2 ←	Serie	30 (0x)
12: 10.4 ↖		
13: 10.0 ←	Total	0 (0x)

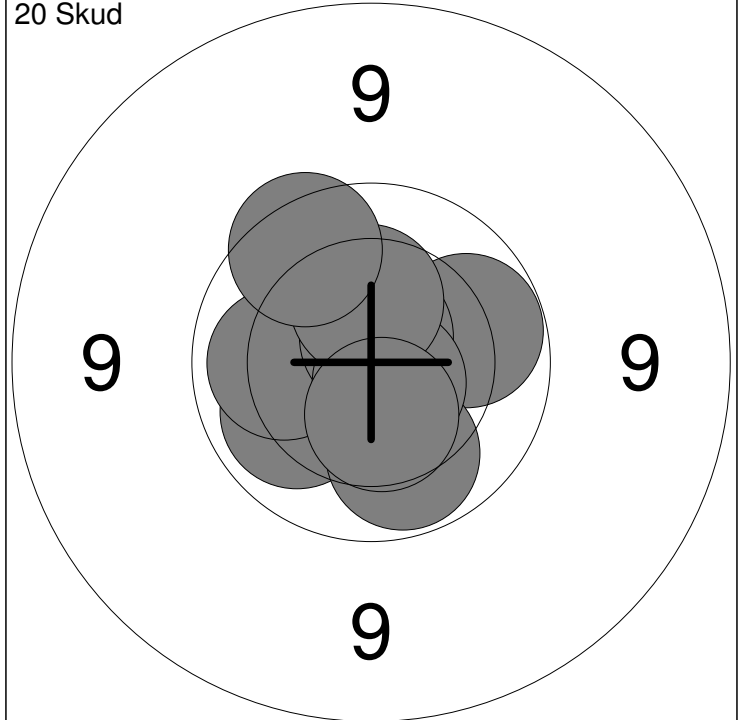
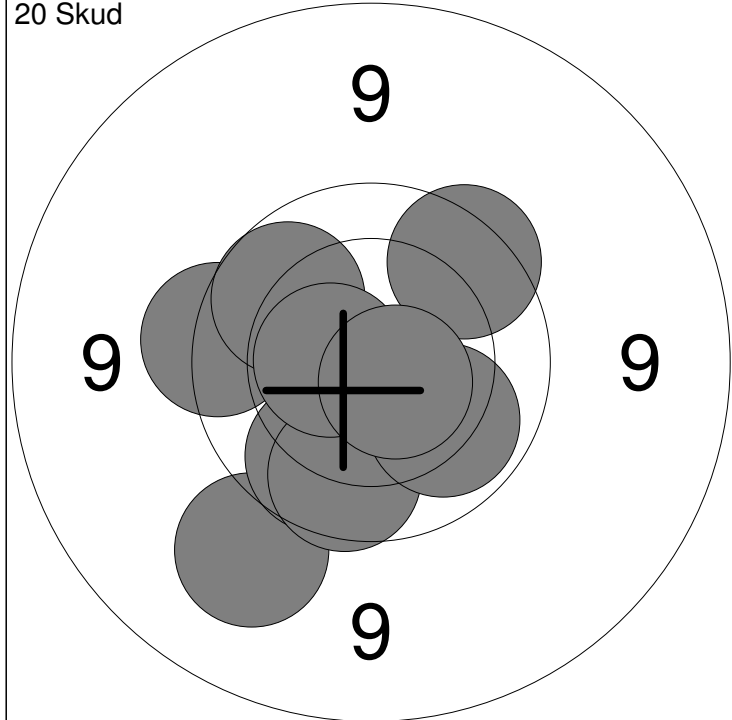

1: 10.3 ↓	6: 10.0 ↘	Serie	94 (2x)
2: 9.3 ↘	7: 9.9 ↗		
3: 9.9 ↘	8: 9.8 ↗	Total	94 (2x)
4: 9.9 ↓	9: 10.6x ←		
5: 9.7 ←	10: 10.6x ↘		

11: 10.1 ↖	16: 10.7x ↑	Serie	99 (2x)
12: 10.2 ↗	17: 10.7x ↘		
13: 10.0 →	18: 10.3 ↑	Total	193 (4x)
14: 10.0 ↓	19: 9.8 ↗		
15: 10.1 ←	20: 10.4 ↓		

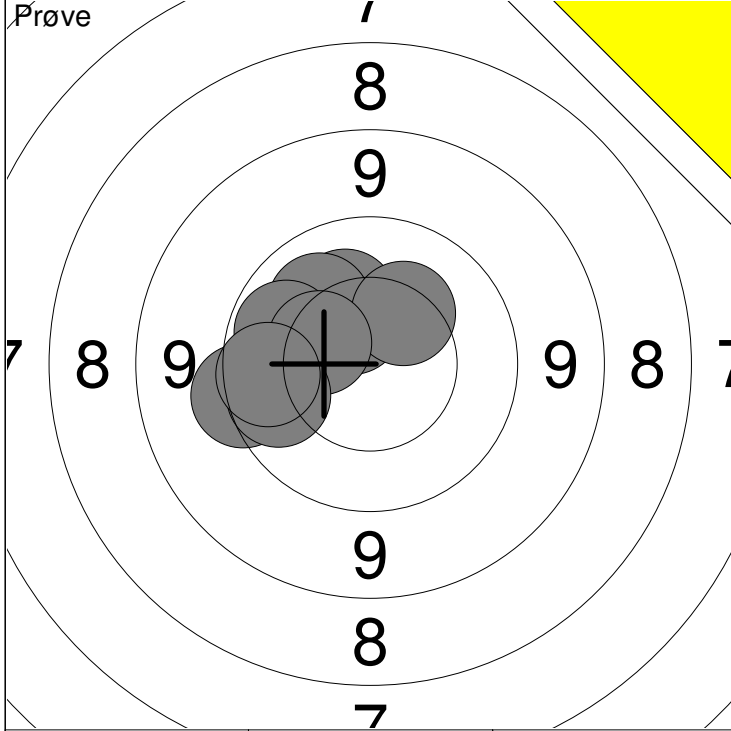

1: 9.5 ←	6: 10.0 ←
2: 10.5 ↗	7: 10.4 ←
3: 10.2 ↗	8: 9.9 ←
4: 10.1 ↗	10: 9.9 ←
5: 10.3 ↗	

Serie	87 (0x)
Total	0 (0x)

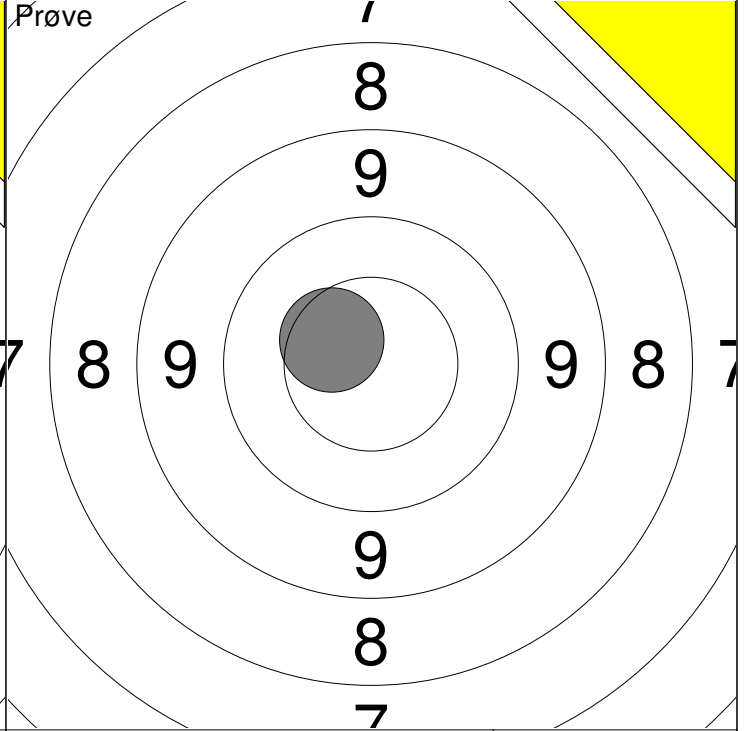

11: 10.5 ←

Serie	10 (0x)
Total	0 (0x)

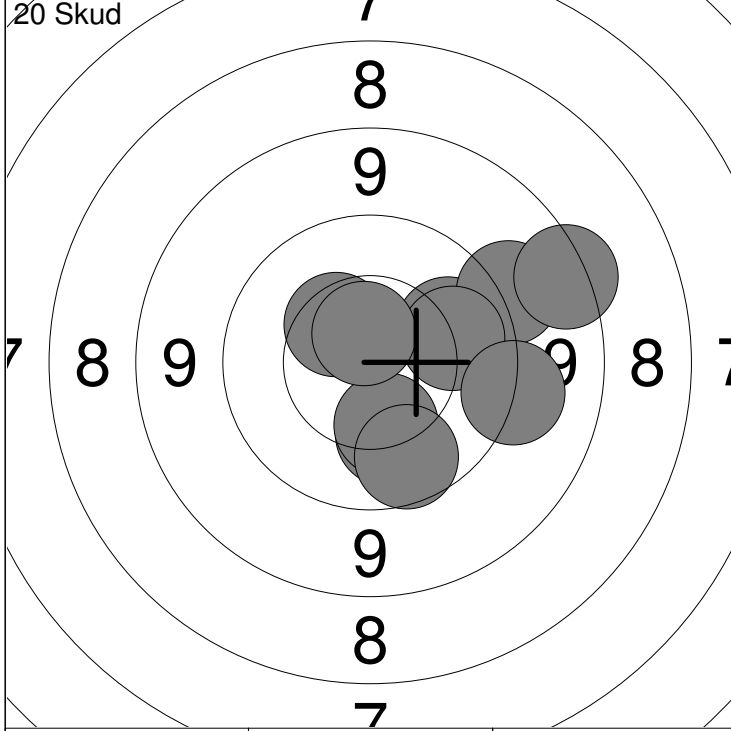

1: 10.2 ↓	6: 10.1 →
2: 10.3 ↓	7: 8.6 →
3: 9.9 ↓	8: 9.4 →
4: 10.1 →	9: 10.4 ↗
5: 9.3 ↗	10: 10.6x ↗

Serie	95 (1x)
Total	95 (1x)

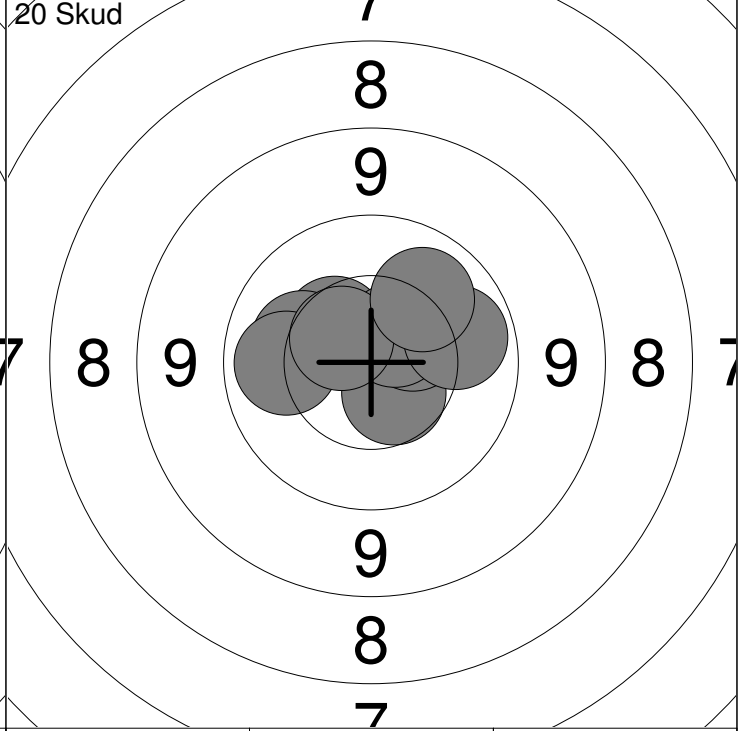

11: 10.4 ↗	16: 10.2 ←
12: 10.6 ↗	17: 10.1 ←
13: 10.6 ↓	18: 10.0 →
14: 10.4 ↗	19: 10.6 ↗
15: 10.6 ↗	20: 10.1 ↗

Serie	100 (0x)
Total	195 (1x)

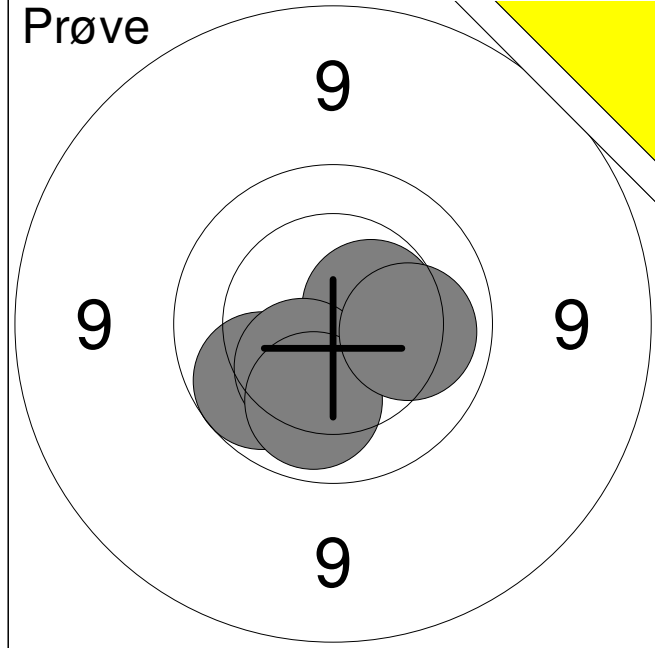

1:	10.5x	→
2:	10.0	↙
3:	10.4	↙
4:	10.1	↓
5:	10.1	→
Serie		50 (1x)
Total		0 (0x)

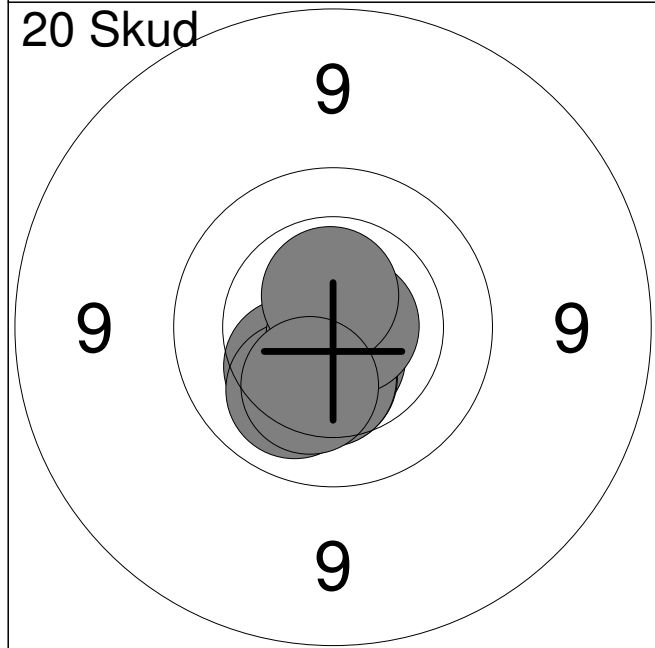

1:	10.6x	↓
2:	10.3	↙
3:	10.4	↓
4:	10.4	↓
5:	10.1	↙
6:	10.8x	↓
7:	10.4	↓
8:	10.8x	→
9:	10.6x	↑
10:	10.3	↓
Serie		100 (4x)
Total		100 (4x)

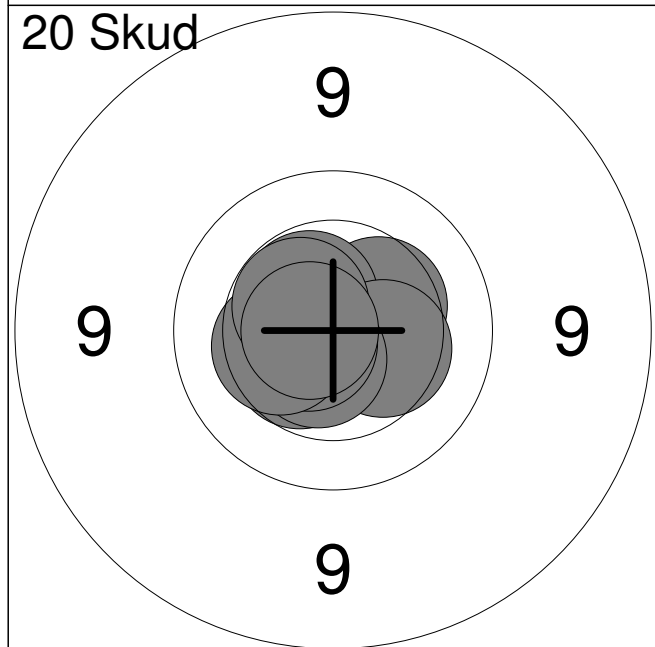

11:	10.4	↗
12:	10.6x	↗
13:	10.5x	↗
14:	10.4	→
15:	10.5	↙
16:	10.6x	↓
17:	10.7x	↙
18:	10.3	←
19:	10.5x	↗
20:	10.7x	←
Serie		100 (6x)
Total		200 (10x)

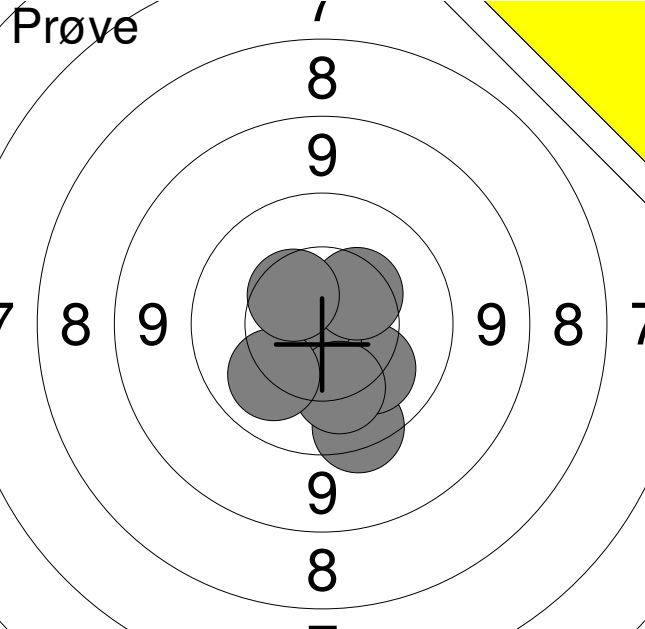
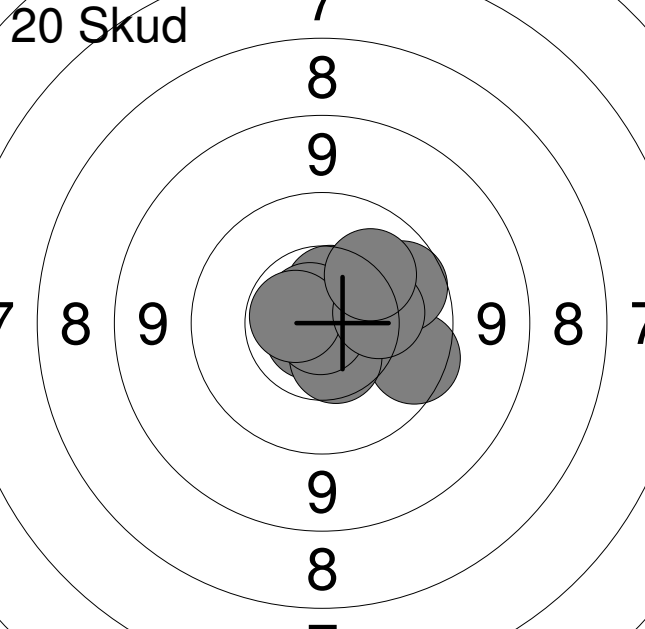
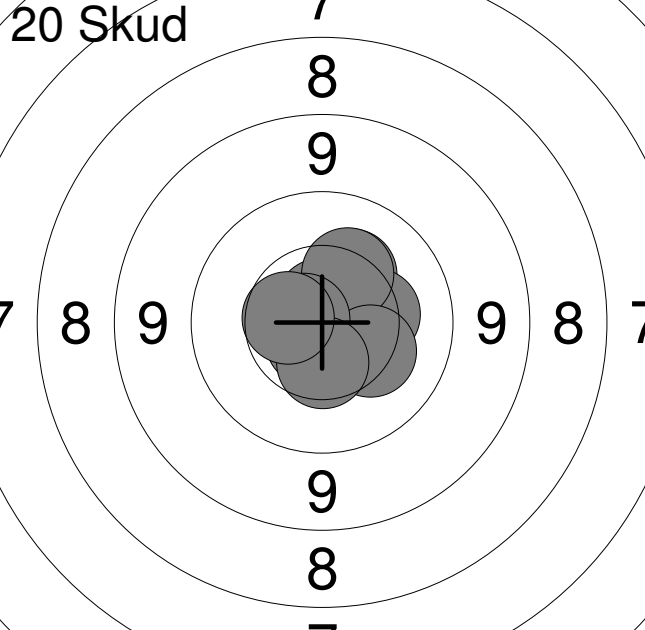
Hold 35	Skive 1	Sune Groen Bendixen	
15 meter		Hjørring Skytteforening	BK1
		Nordjysk mesterskab 2019	Aalborg Skyttekreds
Prøve 	1	9.6	↓
	2	10.2	↓
	3	10.6x	↓
	4	10.8x	←
	5	10.4	↗
	6	10.2	↓
	7	10.1	↙
	8	10.5	↗
	Serie		79 (2x)
Total		0 (0x)	
20 Skud 	1	10.8x	↙
	2	9.8	→
	3	10.6	↑
	4	10.7x	↗
	5	10.5	↓
	6	9.9	↗
	7	10.9x	↓
	8	10.6x	←
	9	10.3	→
	10	10.1	↗
Serie		98 (4x)	
Total		98 (4x)	
20 Skud 	11	10.8x	←
	12	10.7x	↑
	13	10.7x	↙
	14	10.3	↗
	15	10.3	→
	16	10.3	↗
	17	10.3	↙
	18	10.7x	←
	19	10.5	↓
	20	10.5	←
Serie		100 (4x)	
Total		198 (8x)	

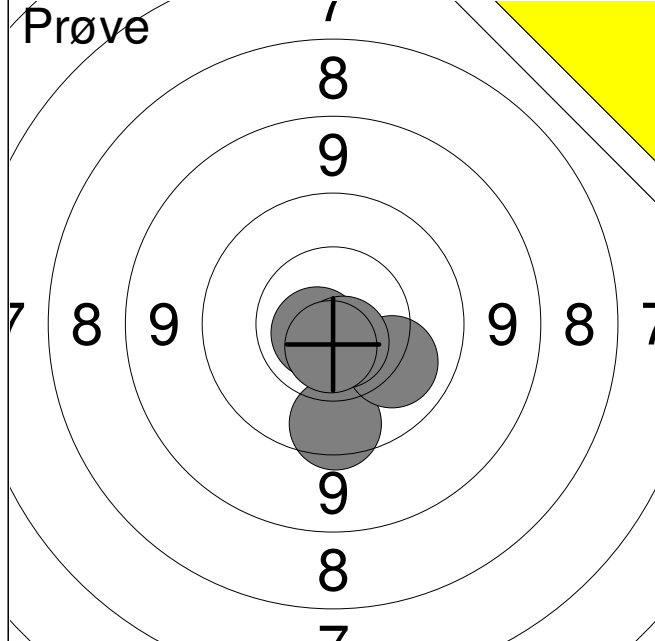

1:	9.7	↓
2:	10.7x	←
3:	10.1	↘
4:	10.7x	↓
5:	10.7x	↓
Serie		49 (3x)
Total		0 (0x)

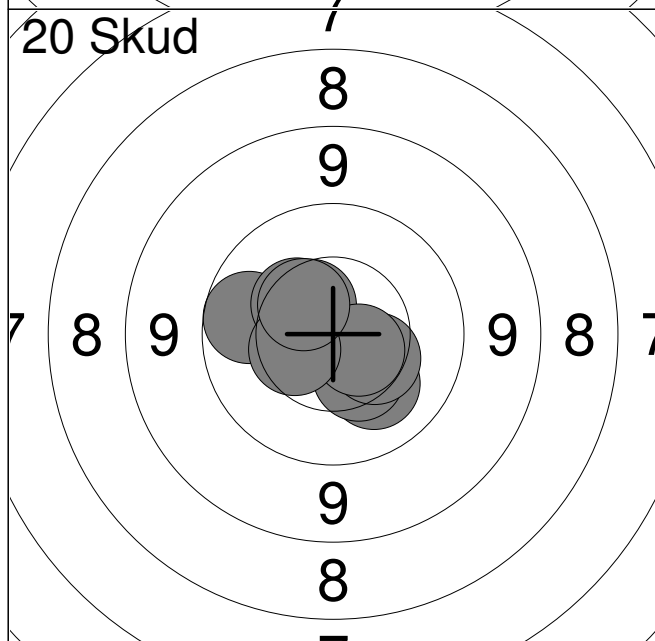

1:	10.6x	↗
2:	10.2	↓
3:	10.4	↓
4:	10.4	↓
5:	9.9	←
6:	10.5	↗
7:	10.4	↗
8:	10.6x	↓
9:	10.5	←
10:	10.5	↗
Serie		99 (2x)
Total		99 (2x)

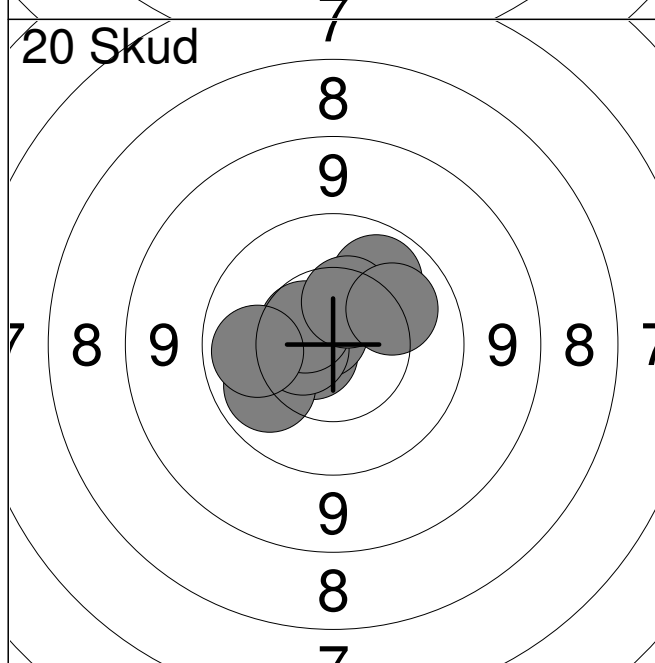

11:	10.6x	←
12:	10.7x	←
13:	10.8x	↗
14:	10.1	←
15:	10.0	↗
16:	10.6x	←
17:	10.6	↗
18:	10.1	←
19:	10.4	↗
20:	10.1	↗
Serie		100 (4x)
Total		199 (6x)

Hold 35	Skive 3	Lucas Pedersen		
15 meter		Frederikshavn Skyttekreds		MBK3
		Nordjysk mesterskab 2019	Aalborg Skyttekreds	
Prøve		1:	9.3	→
		2:	9.9	↘
		3:	9.3	↓
		4:	9.9	↘
		5:	10.8x	←
		6:	10.3	↘
		7:	10.3	←
		Serie	66 (1x)	
		Total	0 (0x)	
20 Skud		1:	10.9x	↗
		2:	10.8x	↗
		3:	10.3	↗
		4:	10.7x	↗
		5:	10.6x	→
		6:	10.7x	↓
		7:	9.4	←
		8:	10.6x	↘
		9:	10.5x	→
		10:	10.3	↙
		Serie	99 (7x)	
		Total	99 (7x)	
20 Skud		11:	10.4	←
		12:	10.4	←
		13:	10.7x	↗
		14:	10.4	↓
		15:	10.4	↘
		16:	9.9	←
		17:	10.5	←
		18:	10.2	→
		19:	9.9	↘
		20:	9.9	←
		Serie	97 (1x)	
		Total	196 (8x)	

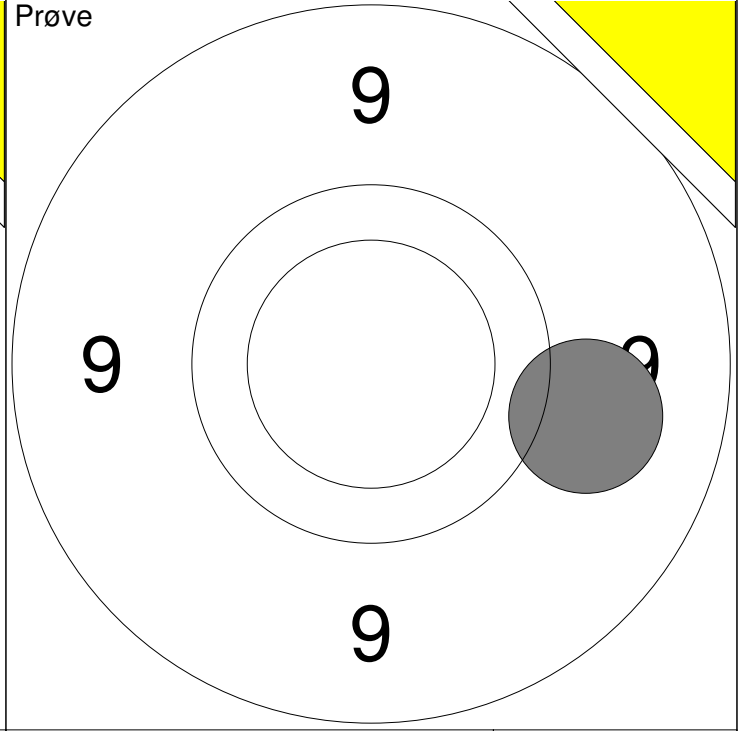
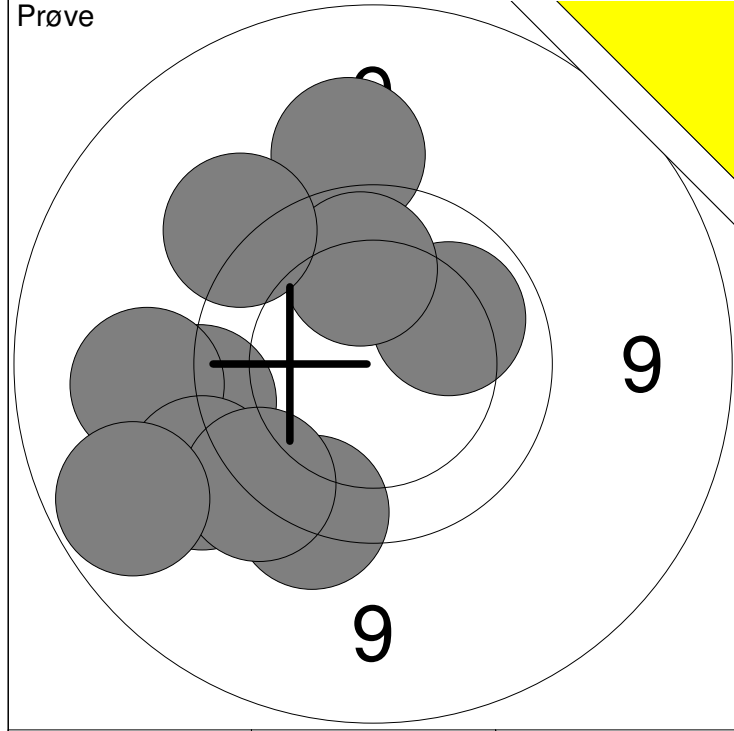

1: 9.3 ↑	6: 10.1 ↗	Serie 92 (0x)
2: 9.5 ←	7: 9.6 ↘	
3: 9.3 ←	8: 10.0 ↑	Total 0 (0x)
4: 9.6 ↓	9: 9.5 ↖	
5: 9.4 ↙	10: 9.0 ↘	

11: 9.3 →	Serie 9 (0x)
	Total 0 (0x)

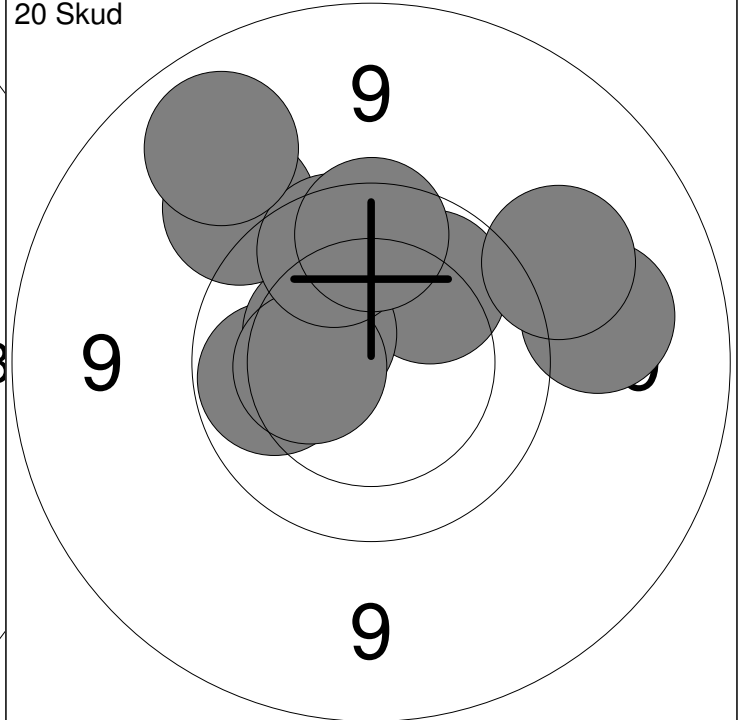
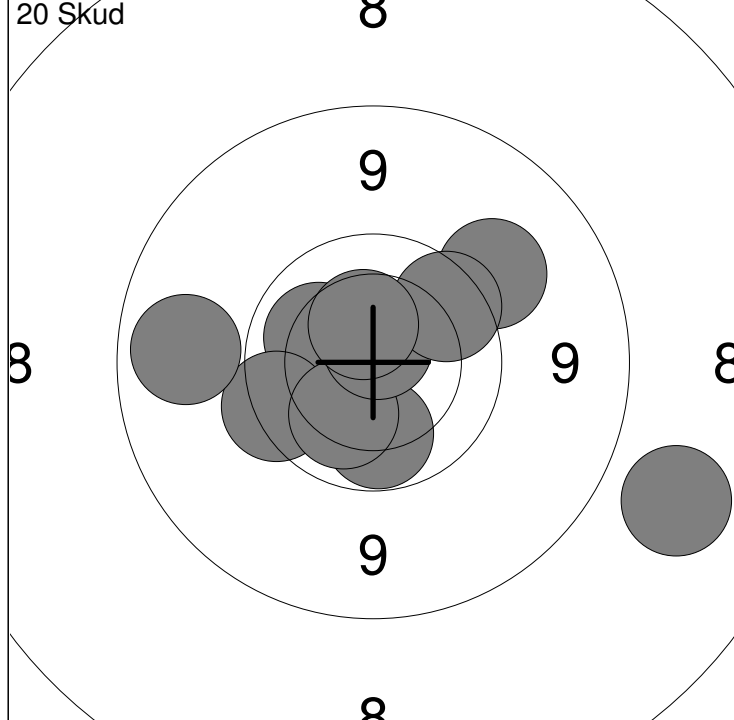

1: 10.0 ↓	6: 9.1 ←	Serie 94 (1x)
2: 10.1 ↖	7: 9.4 ↗	
3: 9.7 ↙	8: 9.8 ↗	Total 94 (1x)
4: 10.1 ↓	9: 8.3 →	
5: 10.7x ↑	10: 10.4 ↑	

11: 10.0 ↗	16: 9.4 ↖	Serie 94 (0x)
12: 10.0 ←	17: 9.9 ↑	
13: 10.4 ↖	18: 9.3 ↗	Total 188 (1x)
14: 9.2 →	19: 9.1 ↖	
15: 10.4 ←	20: 9.8 ↑	

	Nordjysk mesterskab 2019	Aalborg Skyttekreds
--	--------------------------	---------------------

Prøve

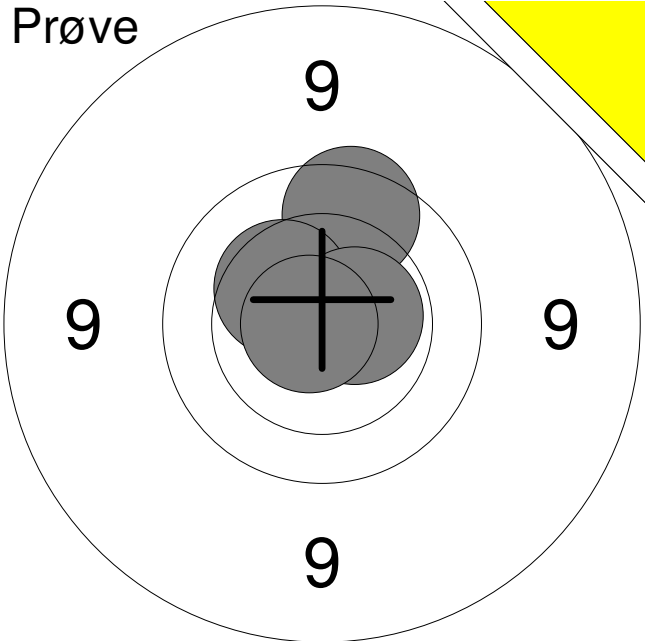

1:	10.7x	↗
2:	9.8	↑
3:	10.4	↖
4:	10.6x	→
5:	10.8x	←

Serie	49 (3x)
Total	0 (0x)

20 Skud

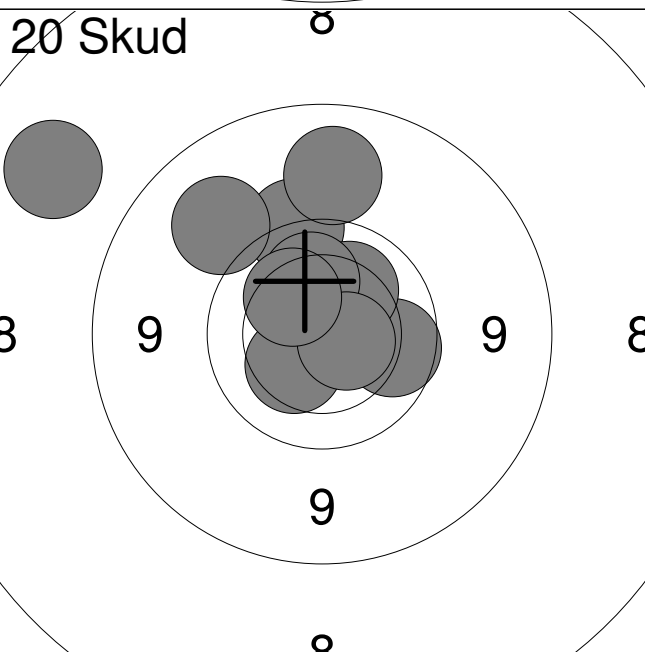

1:	8.2	↖
2:	9.9	→
3:	9.6	↑
4:	9.2	↖
5:	10.2	↗
6:	10.3	↙
7:	10.1	↑
8:	9.1	↑
9:	10.6x	→
10:	10.2	↖

Serie	94 (1x)
Total	94 (1x)

20 Skud

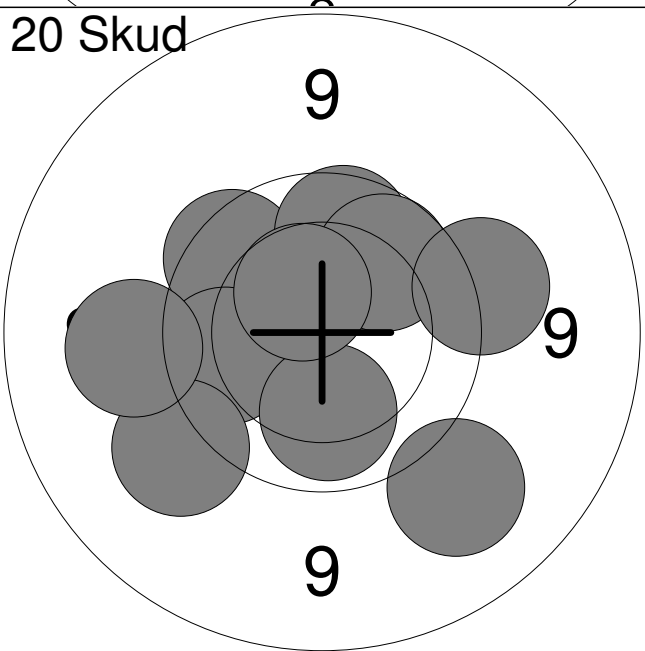

11:	9.8	↖
12:	9.9	↑
13:	9.9	↗
14:	9.9	←
15:	9.5	→
16:	9.2	↙
17:	10.1	↓
18:	10.5	↑
19:	9.4	↙
20:	9.3	←

Serie	92 (0x)
Total	186 (1x)

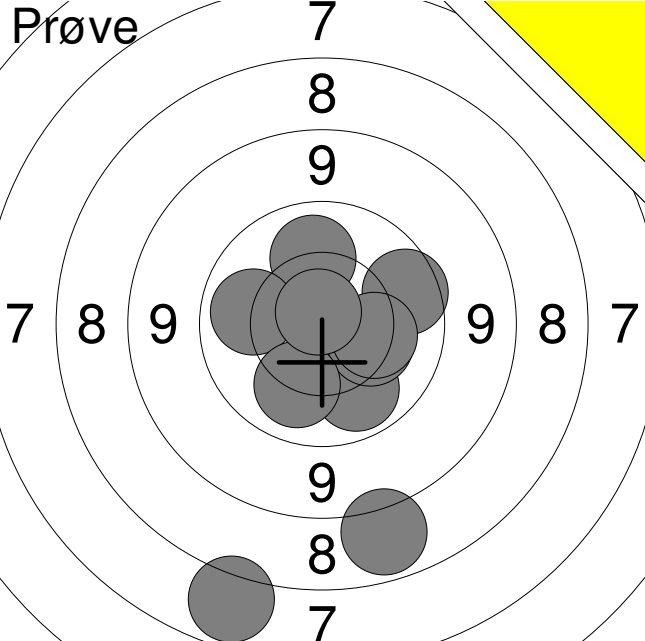
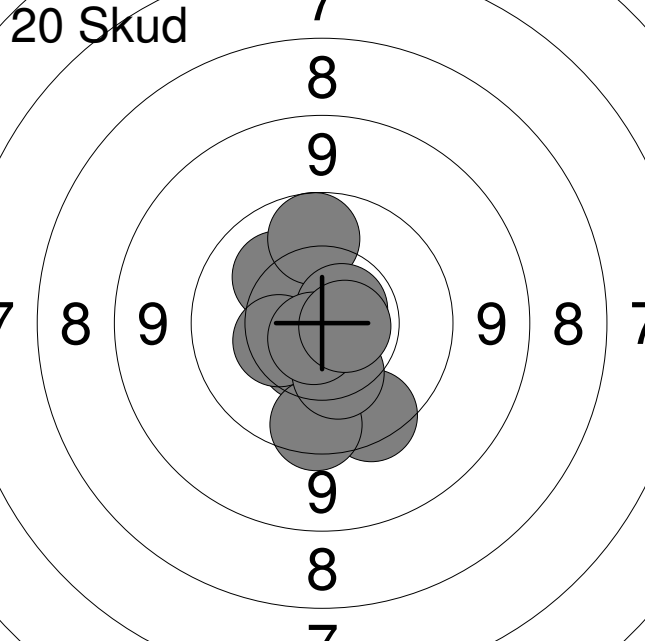
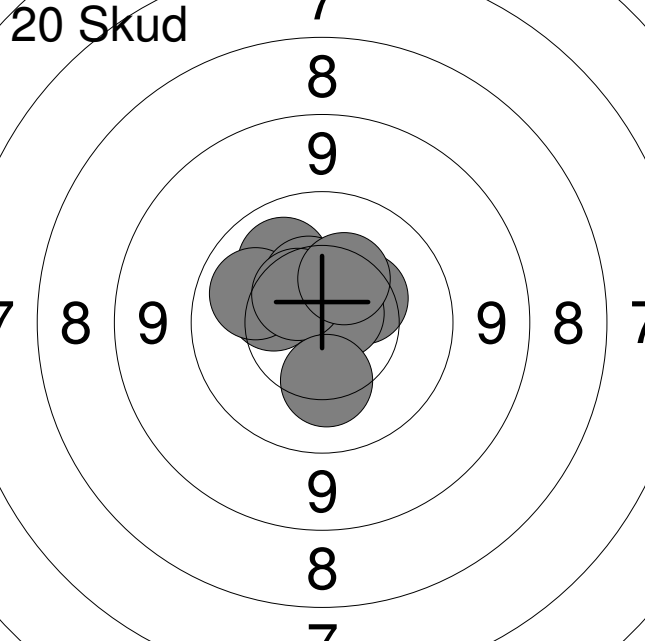
Hold 35	Skive 6	William Joergensen		
15 meter		Vilsted Skytteforening		BK2
		Nordjysk mesterskab 2019	Aalborg Skyttekreds	
Prøve 	7	1:	7.0	↓
	8	2:	8.0	↓
	9	3:	10.0	↓
	7 8 9 9 8 7	4:	10.1	↑
	9	5:	10.3	→
	8	6:	9.8	→
	7	7:	10.1	←
		8:	10.3	→
		9:	10.1	↓
		10:	10.8x	↑
	Serie			
Total				0 (0x)
20 Skud 	7	1:	10.2	↗
	8	2:	9.9	↑
	9	3:	10.7x	↗
	7 8 9 9 8 7	4:	10.5	↓
	9	5:	9.7	↓
	8	6:	9.7	↓
	7	7:	10.4	←
		8:	10.3	↓
		9:	10.7x	↓
		10:	10.7x	→
	Serie			
Total				97 (3x)
20 Skud 	7	11:	10.3	←
	8	12:	10.4	↗
	9	13:	10.1	↑
	7 8 9 9 8 7	14:	10.5	↑
	9	15:	10.1	←
	8	16:	10.7x	↗
	7	17:	10.5	↑
		18:	10.5	↗
		19:	10.3	↓
		20:	10.4	↗
	Serie			
Total				197 (4x)

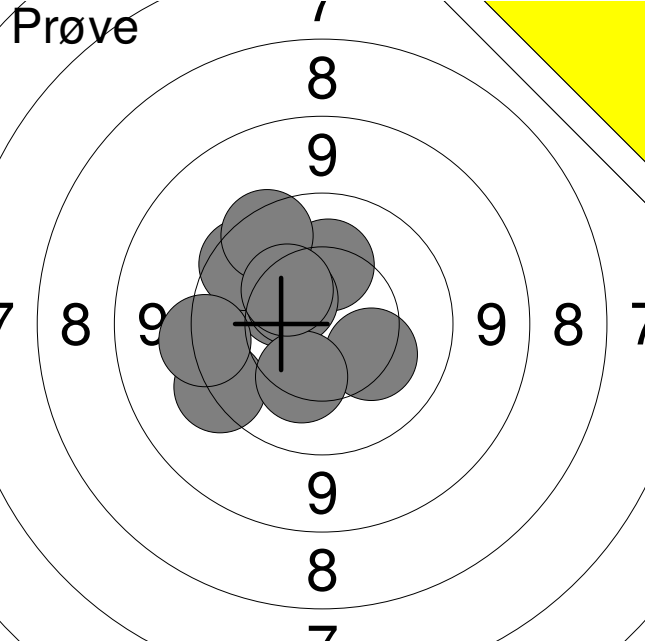
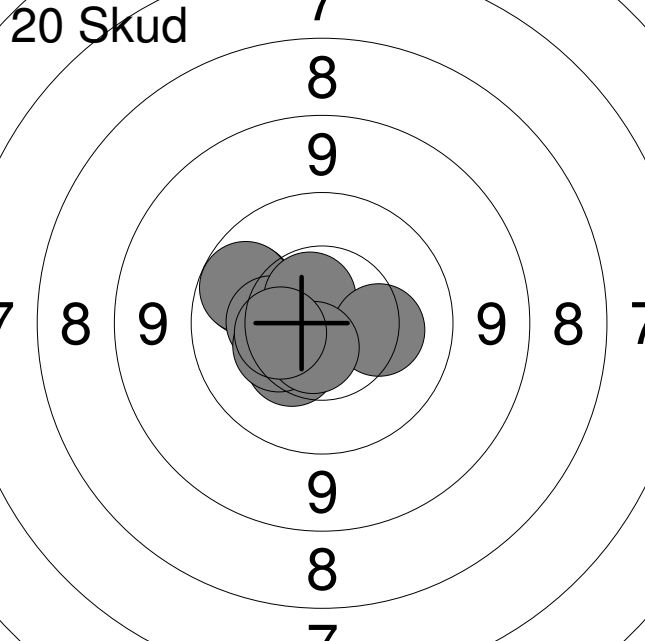
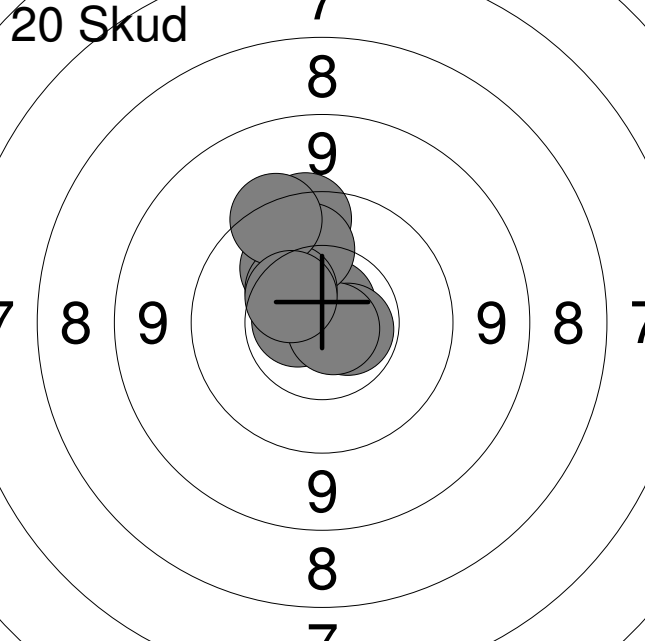
Hold 35	Skive 7	Lai Andersen	
15 meter		Vilsted Skytteforening	BK2
		Nordjysk mesterskab 2019	Aalborg Skyttekreds
Prøve 	1	10.2	↑
	2	10.4	↗
	3	9.8	↗
	4	10.5	↗
	5	10.3	↘
	6	9.5	↖
	7	9.5	↖
	8	10.3	↘
	9	9.7	↗
	10	10.4	↗
	Serie		96 (0x)
Total		0 (0x)	
20 Skud 	1	10.0	↖
	2	10.4	↖
	3	10.0	↗
	4	10.4	↘
	5	10.4	↖
	6	10.4	↖
	7	10.6x	↗
	8	10.3	→
	9	10.6x	↘
	10	10.4	↖
Serie		100 (2x)	
Total		100 (2x)	
20 Skud 	11	10.7x	↗
	12	10.6x	→
	13	10.7x	↖
	14	10.2	↗
	15	10.8x	↘
	16	9.7	↑
	17	10.1	↑
	18	10.4	↗
	19	9.6	↗
	20	10.5	↗
Serie		98 (4x)	
Total		198 (6x)	

Hold 35	Skive 8	Elias Erbs		
15 meter		Frederikshavn Skyttekreds		MBK2
		Nordjysk mesterskab 2019	Aalborg Skyttekreds	
Prøve		1:	10.1	↖
		2:	10.5x	↖
		3:	10.3	→
		4:	9.9	↑
		5:	9.4	↘
		6:	9.9	↗
		7:	10.7x	↓
		8:	10.5x	↗
		Serie		77 (3x)
		Total		0 (0x)
20 Skud		1:	9.8	→
		2:	10.3	↗
		3:	10.3	↗
		4:	10.4	→
		5:	9.7	↑
		6:	10.3	↑
		7:	9.8	↗
		8:	9.7	↑
		9:	10.0	←
		10:	10.4	→
		Serie		96 (0x)
		Total		96 (0x)
20 Skud		11:	10.6x	→
		12:	10.2	↗
		13:	9.9	↗
		14:	9.7	↓
		15:	10.1	↗
		16:	9.9	↑
		17:	10.1	↘
		18:	9.8	↗
		19:	9.9	↗
		20:	9.9	→
		Serie		94 (1x)
		Total		190 (1x)

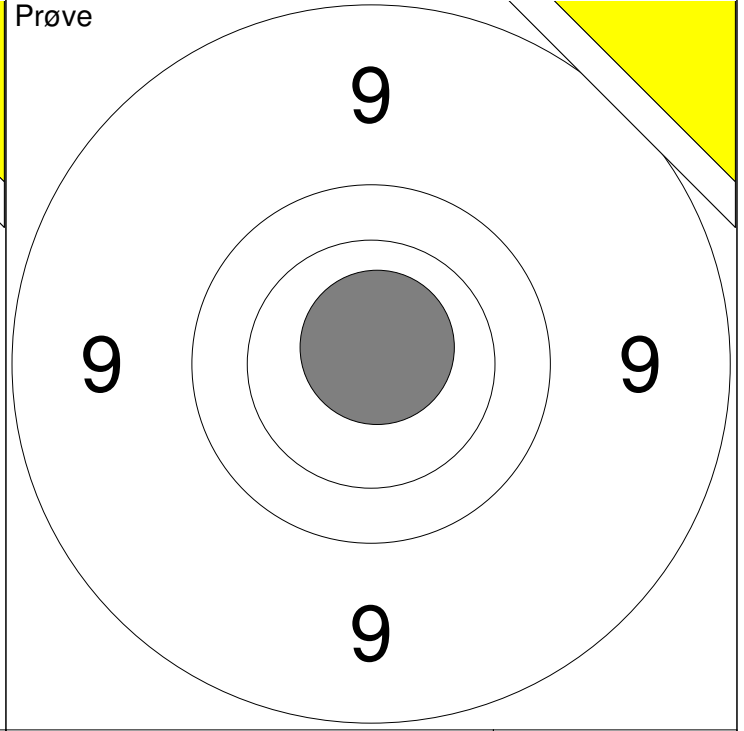
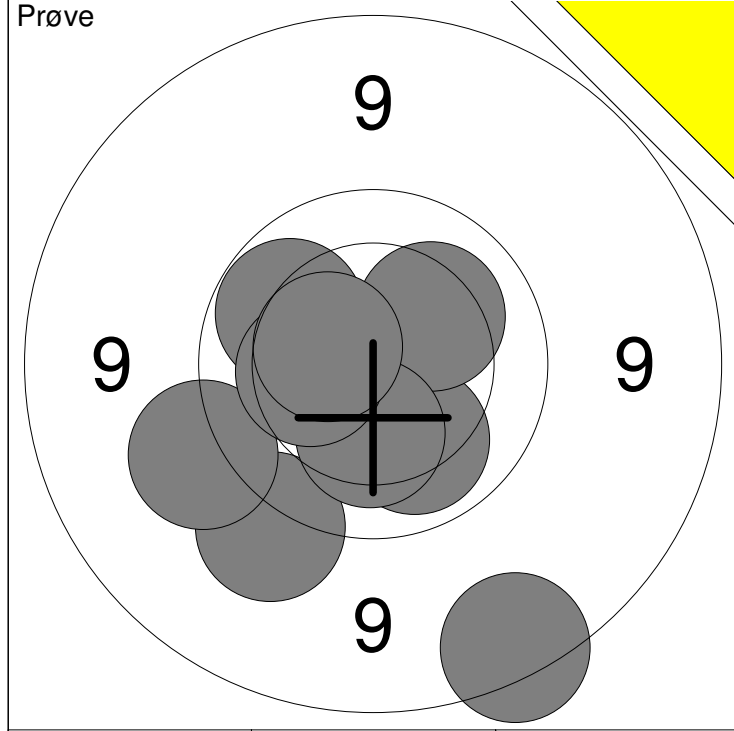

1: 8.8 ↘	6: 10.1 ↘	Serie	96 (1x)
2: 9.4 ↘	7: 10.2 ↗		
3: 9.4 ↙	8: 10.3 ↓	Total	0 (0x)
4: 10.7x ↙	9: 10.3 ←		
5: 10.0 ↖	10: 10.5 ↖		

11: 10.8x ↗	Serie	10 (1x)
	Total	0 (0x)

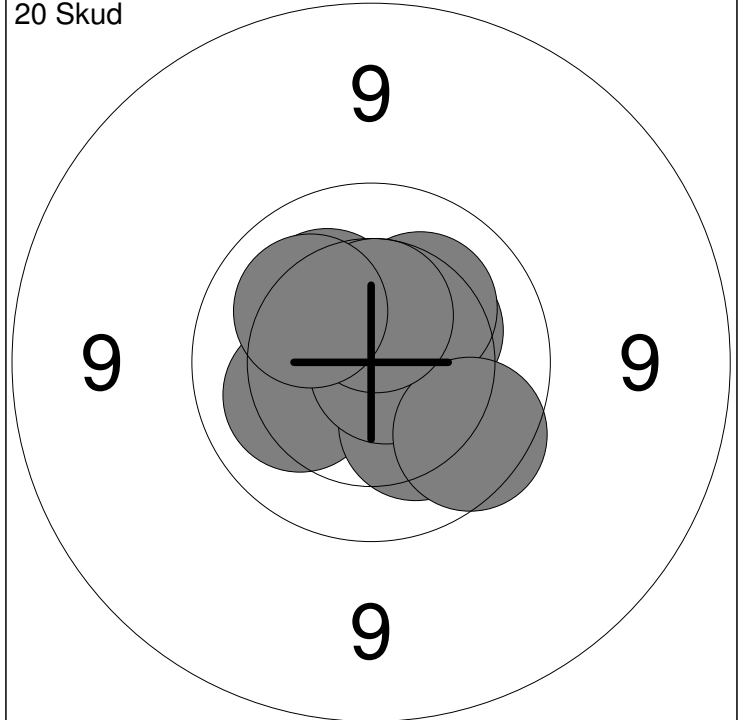
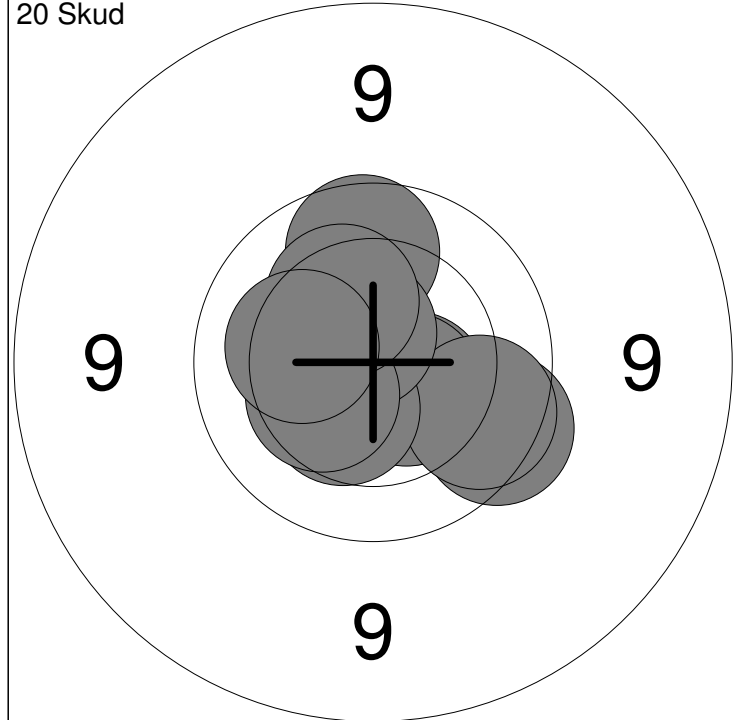

1: 9.9 ↗	6: 10.4 ↘	Serie	97 (3x)
2: 10.5x ↘	7: 10.6x ↗		
3: 9.7 ↘	8: 10.4 ↙	Total	97 (3x)
4: 10.5x ↘	9: 10.3 ↗		
5: 9.9 ↘	10: 10.2 ←		

11: 10.3 ←	16: 10.2 ↗	Serie	99 (2x)
12: 10.3 ↗	17: 9.8 ↘		
13: 10.2 ←	18: 10.2 ↗	Total	196 (5x)
14: 10.2 ↘	19: 10.5x ↗		
15: 10.8x ↗	20: 10.2 ↙		

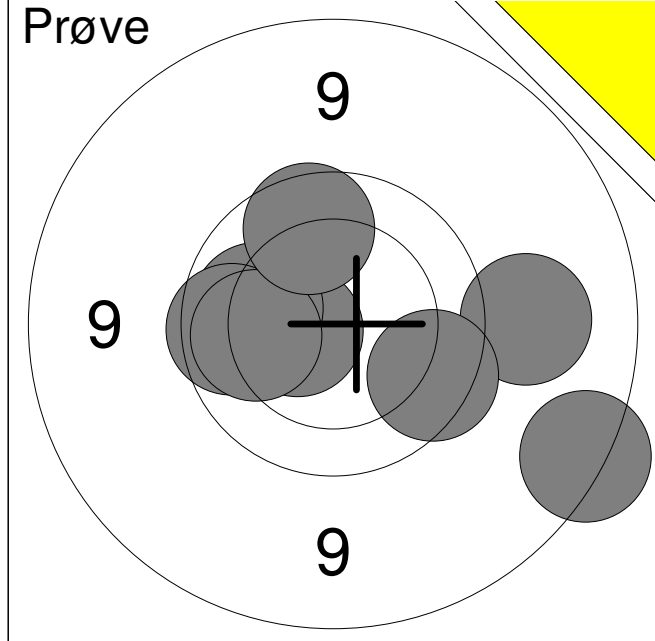

1:	9.3	→
2:	8.8	↘
3:	9.8	↘
4:	10.5x	←
5:	10.1	←
6:	9.9	←
7:	10.1	←
8:	9.9	↑
Serie	74 (1x)	
Total	0 (0x)	

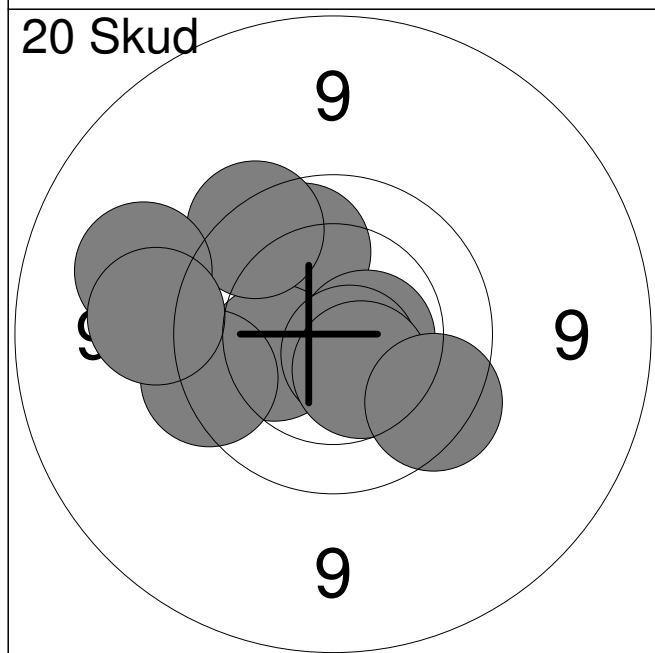

1:	10.0	↑
2:	10.6x	→
3:	10.3	←
4:	9.7	←
5:	10.7x	↘
6:	9.7	↗
7:	9.3	↖
8:	9.4	←
9:	10.4	↘
10:	9.8	↘
Serie	95 (2x)	
Total	95 (2x)	

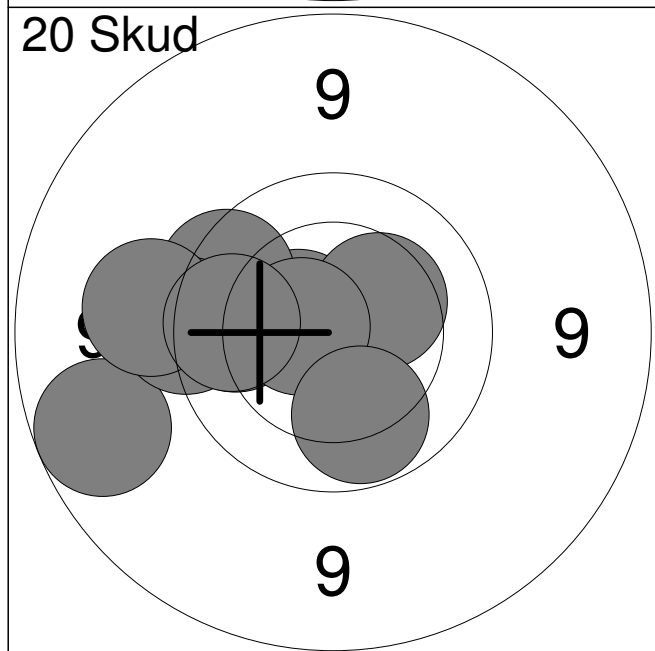

11:	9.9	←
12:	10.5x	↖
13:	9.0	←
14:	10.3	↗
15:	9.8	↖
16:	9.6	←
17:	9.4	←
18:	10.6x	←
19:	9.9	←
20:	10.0	↘
Serie	94 (2x)	
Total	189 (4x)	

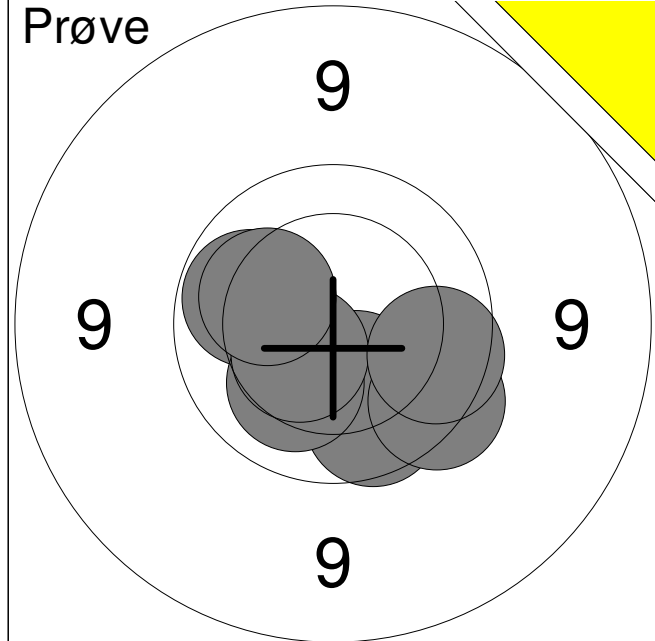

1:	10.0	↖
2:	10.3	↘
3:	9.9	↘
4:	9.7	↘
5:	10.2	↘
6:	10.5	↖
7:	9.8	↗
8:	10.2	↖
Serie		77 (0x)
Total		0 (0x)

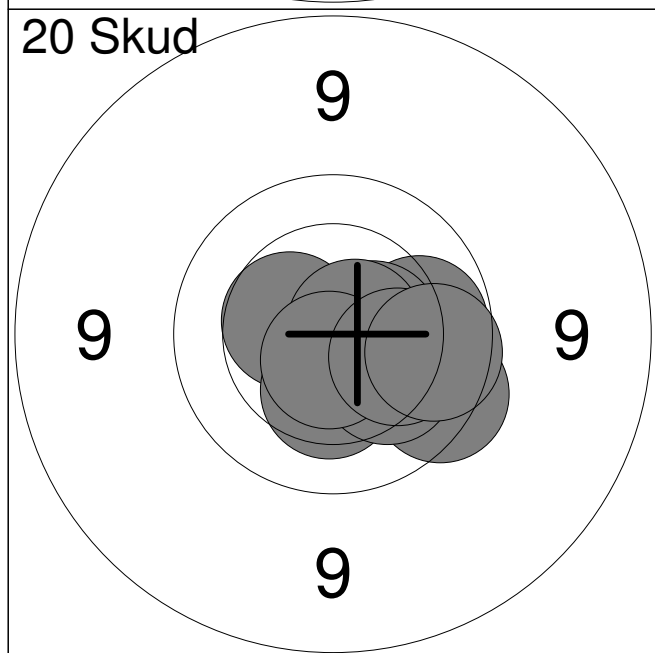

1:	10.0	→
2:	9.7	↘
3:	10.4	↖
4:	10.5x	→
5:	10.3	↘
6:	10.2	↘
7:	10.7x	→
8:	10.7x	↘
9:	10.2	↗
10:	9.9	→
Serie		98 (3x)
Total		98 (3x)

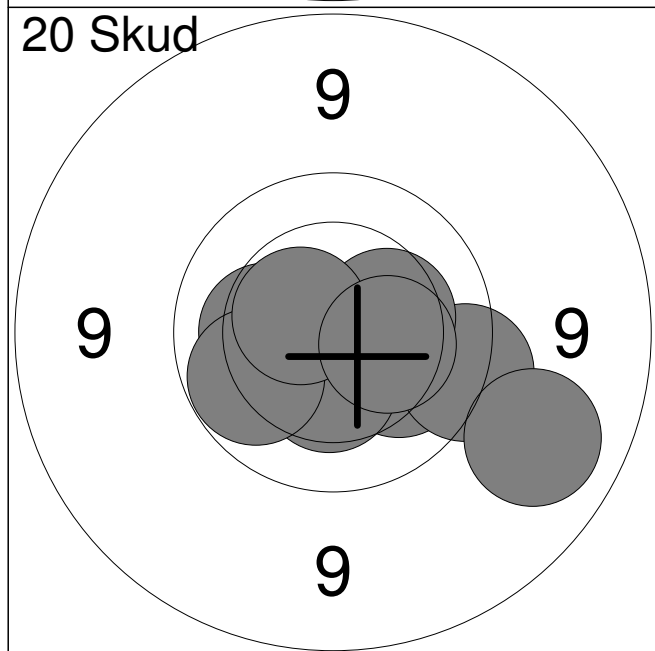

11:	10.2	→
12:	10.1	↘
13:	9.6	↗
14:	10.4	↘
15:	10.2	↖
16:	9.1	↘
17:	10.3	→
18:	10.0	↖
19:	10.5x	↖
20:	10.3	→
Serie		98 (1x)
Total		196 (4x)

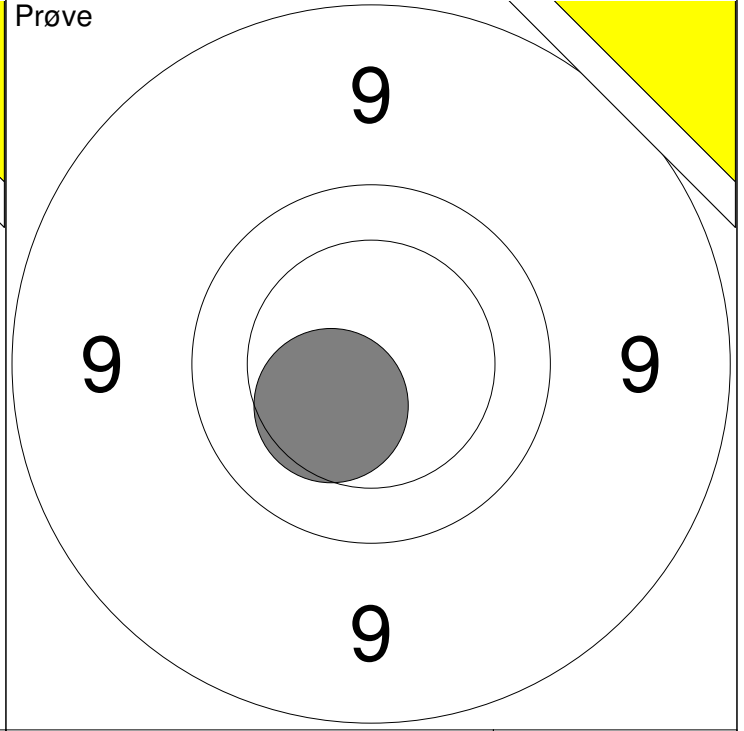
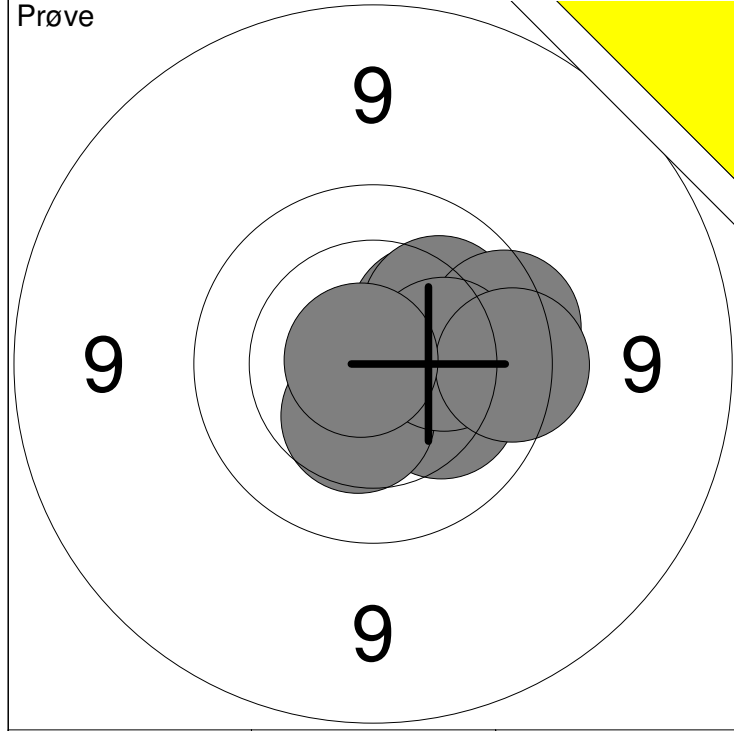

1: 10.3 ↗	6: 10.4 ↓	Serie	88 (2x)
2: 10.5x ➤	8: 10.2 ➔		
3: 10.1 ↗	9: 9.7 ➔	Total	0 (0x)
4: 10.2 ➤	10: 10.8x ←		
5: 9.8 ➔			

11: 10.4 ↙		Serie	10 (0x)
		Total	0 (0x)

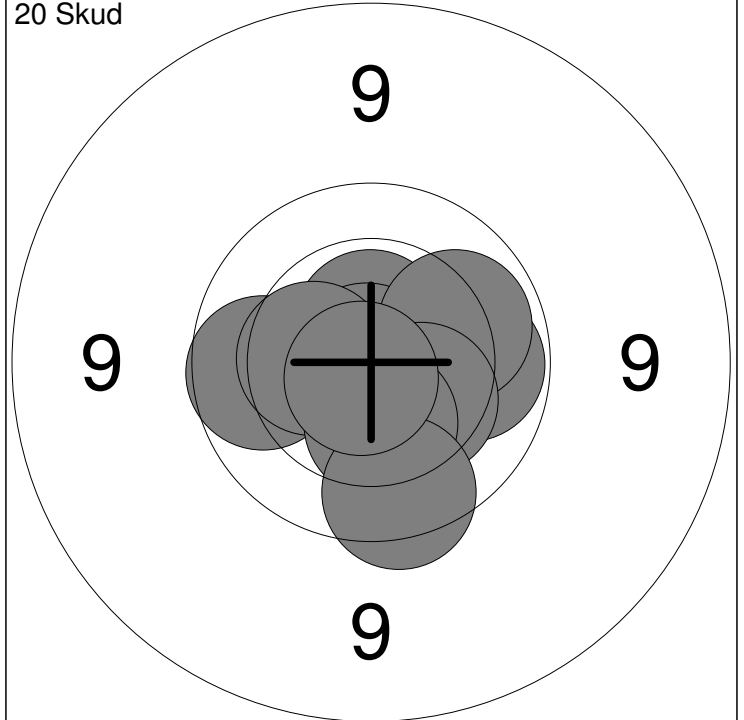
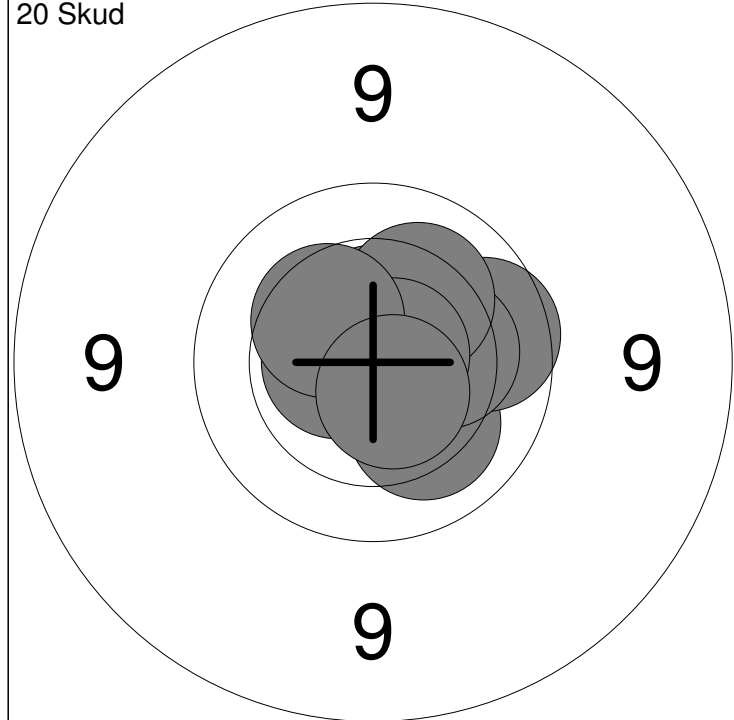

1: 10.7x ↘	6: 10.6x ←	Serie	99 (5x)
2: 10.2 ↘	7: 10.2 ↗		
3: 9.9 ➔	8: 10.7x ➔	Total	99 (5x)
4: 10.3 ➔	9: 10.3 ↖		
5: 10.6x ↑	10: 10.6x ↘		

11: 10.6x ↑	16: 10.4 ←	Serie	98 (3x)
12: 9.9 ←	17: 10.3 ↘		
13: 10.9x ↖	18: 10.3 ↘	Total	197 (8x)
14: 10.0 ➔	19: 9.8 ↘		
15: 10.1 ➔	20: 10.8x ↘		

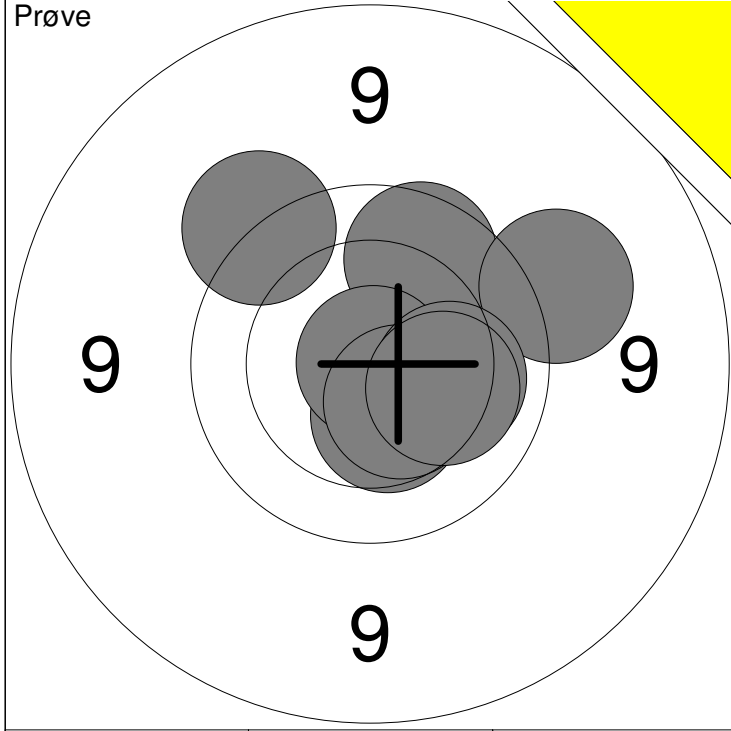

1: 9.9 ↗	7: 10.5 ↘	Serie	77 (1x)
3: 9.5 ↖	9: 10.2 →		
4: 9.4 →	10: 10.2 ↘	Total	0 (0x)
5: 10.4 ↘			
6: 10.9x ↗			

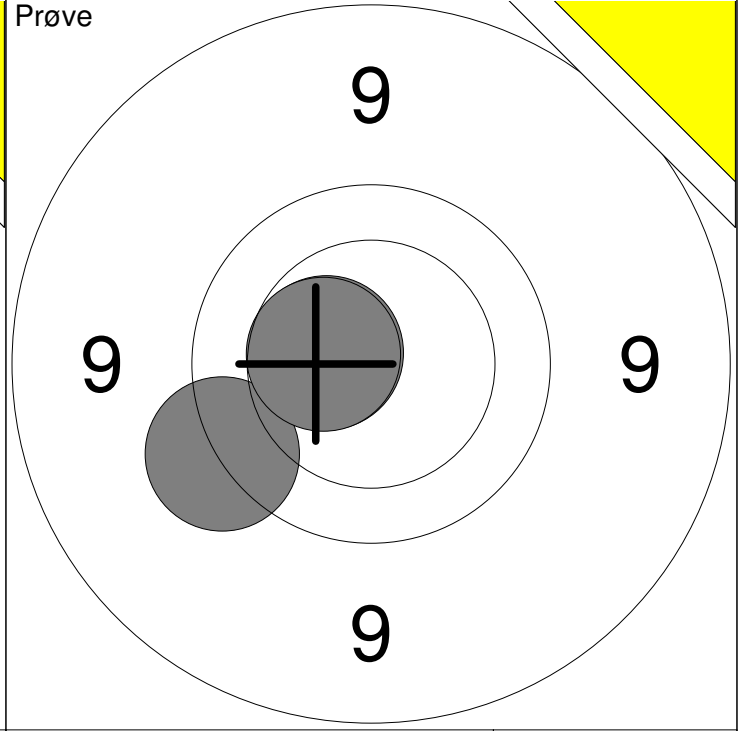

11: 9.5 ↙	Serie	29 (1x)
12: 10.5x ↖		
13: 10.5 ↖	Total	0 (0x)

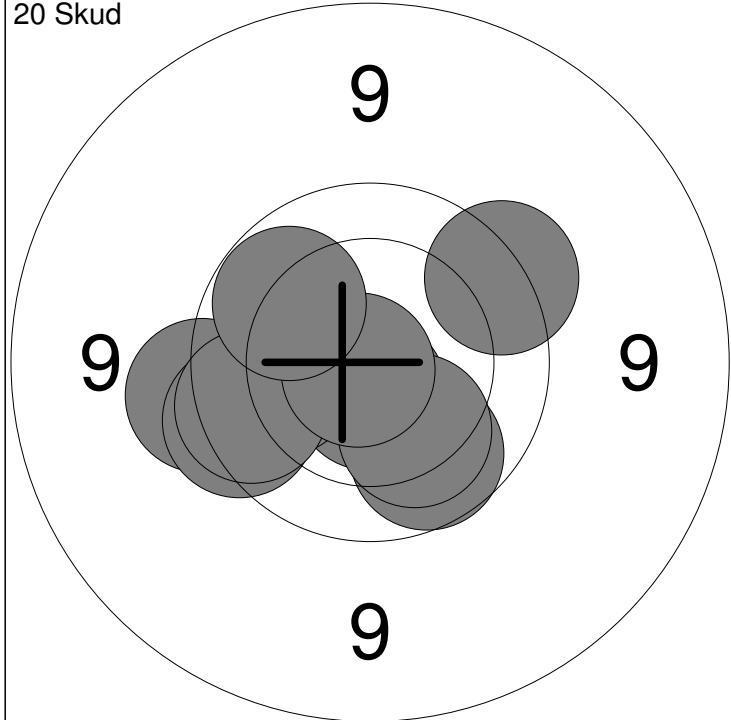

1: 9.9 ↘	6: 9.7 ↖	Serie	95 (2x)
2: 10.6x ↘	7: 9.8 ↖		
3: 10.1 ↖	8: 9.6 ↗	Total	95 (2x)
4: 9.6 ↖	9: 10.8x ↖		
5: 10.2 ↘	10: 10.0 ↖		

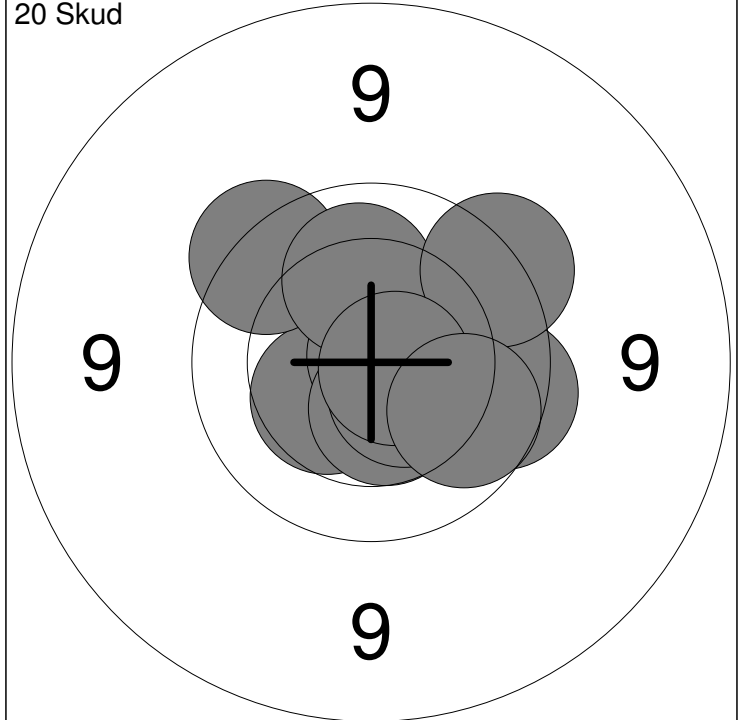

11: 9.8 →	16: 10.1 ↗	Serie	96 (3x)
12: 10.4 ↖	17: 10.5x ↘		
13: 9.7 ↖	18: 9.6 ↗	Total	191 (5x)
14: 10.8x ↗	19: 10.7x →		
15: 10.5 ↘	20: 9.9 ↘		

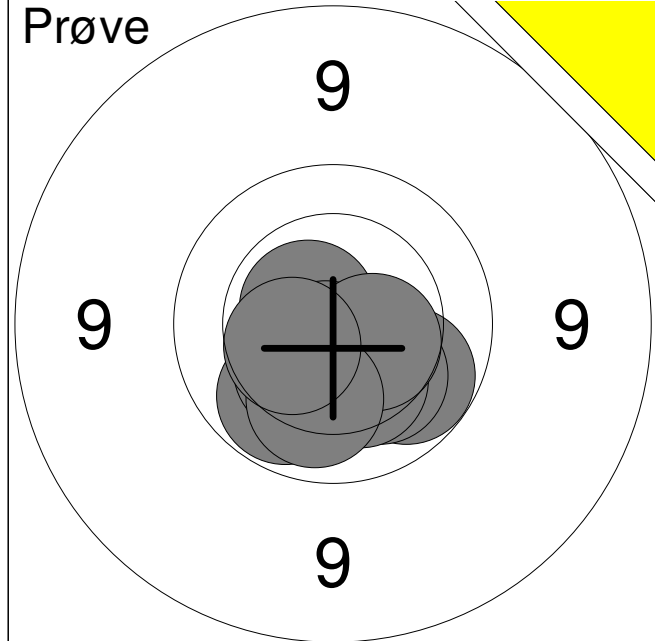

1:	10.0	↘
2:	10.0	↘
3:	10.6x	↗
4:	10.2	↘
5:	10.7x	↘
6:	10.4	↘
7:	10.3	↘
8:	10.5	↘
9:	10.1	↘
10:	10.4	↙
Serie		100 (2x)
Total		0 (0x)

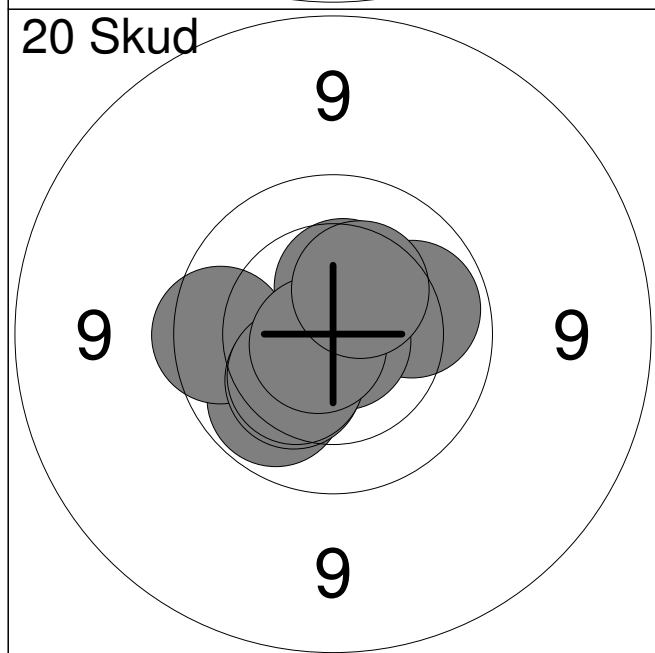

1:	10.9x	→
2:	10.4	↑
3:	10.0	↘
4:	10.0	→
5:	10.8x	↘
6:	9.8	←
7:	10.3	↘
8:	10.3	↘
9:	10.7x	↙
10:	10.4	↗
Serie		99 (3x)
Total		99 (3x)

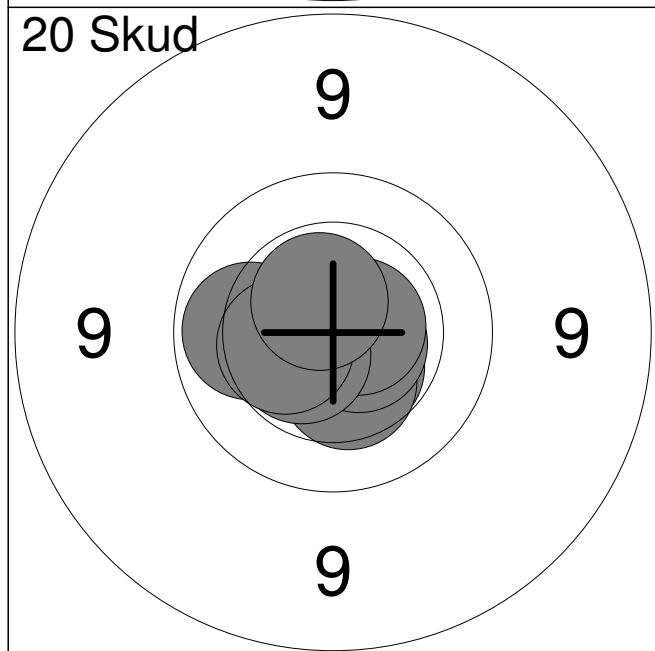

11:	10.5x	↘
12:	10.8x	↘
13:	10.4	↘
14:	10.6x	↘
15:	10.6x	←
16:	10.7x	→
17:	10.0	←
18:	10.5x	↙
19:	10.4	←
20:	10.6x	↗
Serie		100 (7x)
Total		199 (10x)

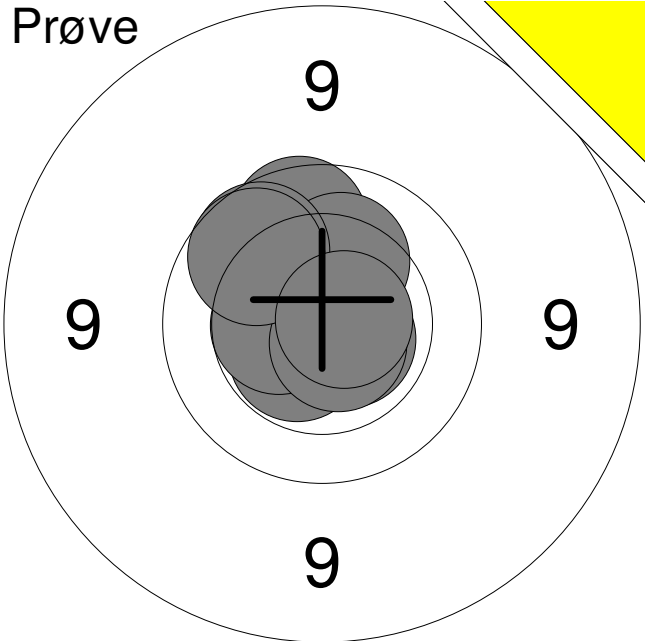
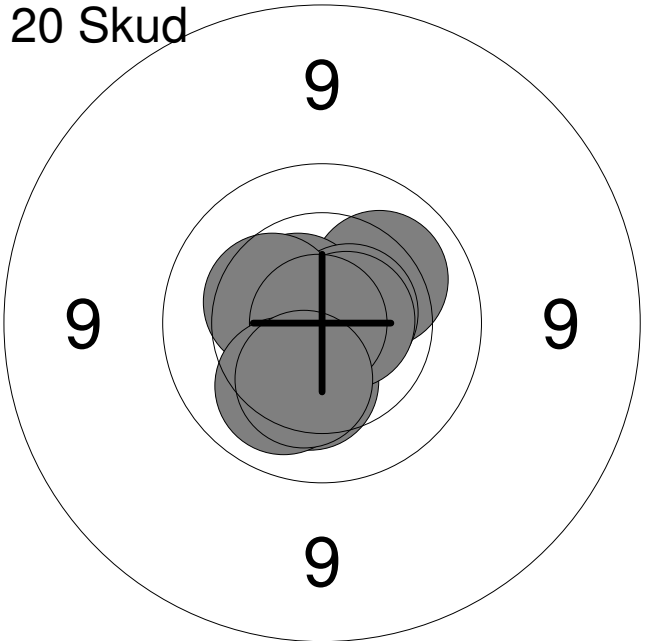
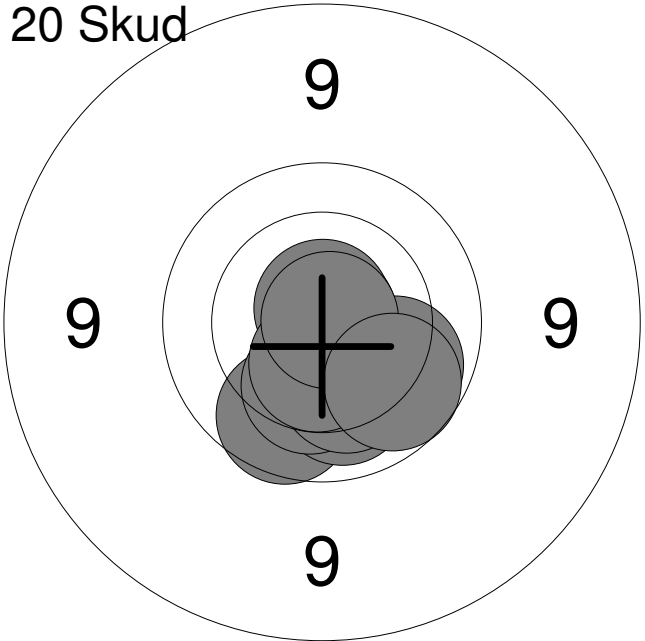
Hold 36	Skive 4	Josefine Frydkaer		
15 meter		Frederikshavn Skyttekreds		MBK3
		Nordjysk mesterskab 2019	Aalborg Skyttekreds	
Prøve 	1:	9.9	↑	
	2:	10.5x	↙	
	3:	10.6x	↗	
	4:	10.5	←	
	5:	10.2	↑	
	6:	10.6x	↘	
	7:	9.9	↗	
	8:	10.7x	↘	
	9:	9.9	↗	
	10:	10.7x	→	
	Serie			97 (5x)
Total			0 (0x)	
20 Skud 	1:	10.5x	↖	
	2:	10.1	↗	
	3:	10.6x	↗	
	4:	10.3	↓	
	5:	10.6x	→	
	6:	10.7x	→	
	7:	10.4	↖	
	8:	10.9x	←	
	9:	10.1	↓	
	10:	10.3	↓	
	Serie			100 (5x)
Total			100 (5x)	
20 Skud 	11:	9.9	↓	
	12:	10.9x	↗	
	13:	10.1	↓	
	14:	10.8x	↑	
	15:	10.2	↓	
	16:	10.2	↓	
	17:	10.0	↘	
	18:	10.5x	↓	
	19:	10.9x	→	
	20:	9.9	↘	
	Serie			98 (4x)
Total			198 (9x)	

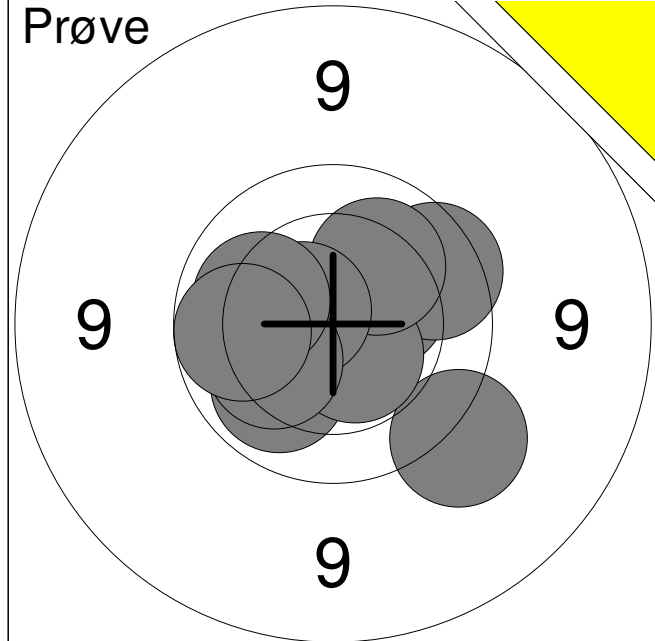

1:	9.5	↘
2:	10.1	↙
3:	10.4	↗
4:	9.8	↗
5:	10.5x	↘
6:	10.2	↗
7:	10.6x	↖
8:	10.2	↖
9:	10.1	↖
10:	9.9	↖
Serie		97 (2x)
Total		0 (0x)

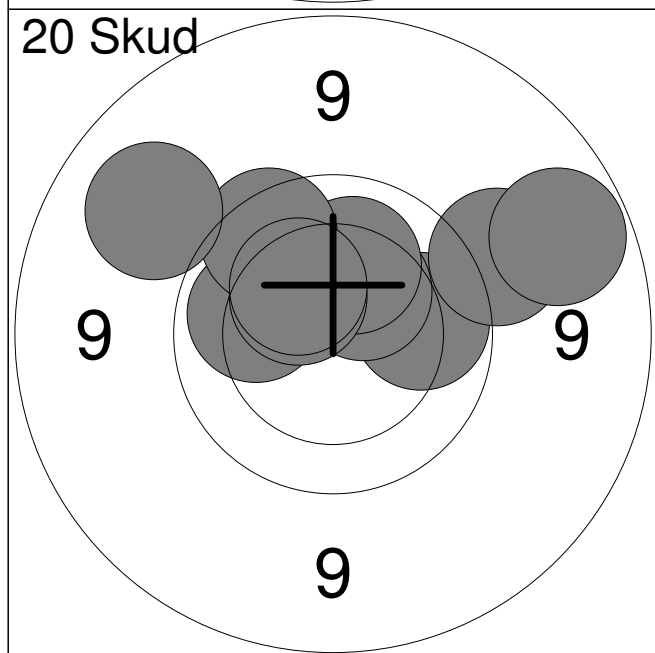

1:	10.1	↖
2:	10.0	→
3:	10.4	↗
4:	10.2	↗
5:	10.4	↗
6:	9.8	↗
7:	9.4	↗
8:	9.0	↗
9:	9.2	↗
10:	10.3	↗
Serie		96 (0x)
Total		96 (0x)

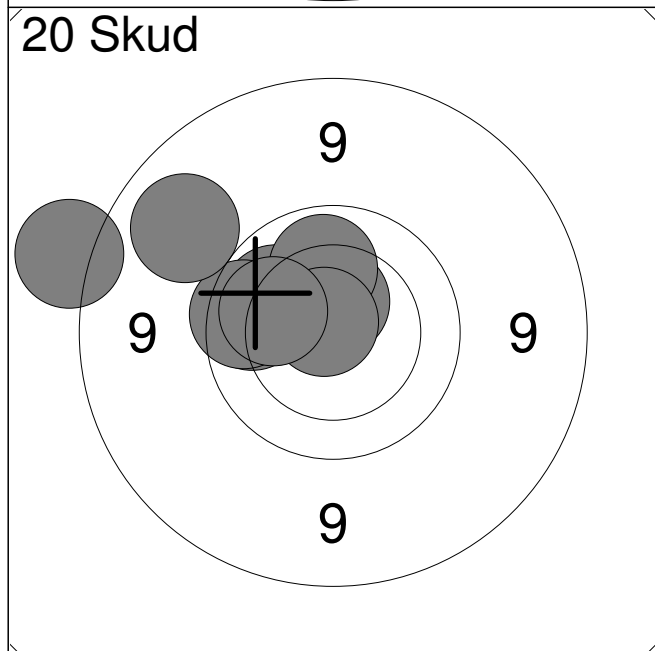

11:	9.9	↖
12:	8.6	↖
13:	10.0	↗
14:	10.5x	↑
15:	9.9	↖
16:	9.8	↖
17:	10.1	↑
18:	10.8x	↗
19:	9.1	↗
20:	10.1	↖
Serie		94 (2x)
Total		190 (2x)

Hold 36	Skive 6	Mathias Beith_Jensen		
15 meter		Pandrup Skytteforening		MJ2
		Nordjysk mesterskab 2019	Aalborg Skyttekreds	
Prøve		1:	9.3	↙
		2:	9.3	↙
		3:	9.9	↗
		4:	9.8	→
		5:	9.3	↗
		6:	10.3	↘
		Serie		55 (0x)
		Total		0 (0x)
20 Skud		1:	9.3	→
		2:	9.1	↙
		3:	9.9	↓
		4:	10.3	↙
		5:	10.5x	↓
		6:	9.7	↙
		7:	9.5	↙
		8:	9.5	←
		9:	9.1	←
		10:	9.7	←
		Serie		92 (1x)
		Total		92 (1x)
20 Skud		11:	10.4	↙
		12:	10.1	↙
		13:	10.8x	↗
		14:	9.9	↗
		15:	9.3	↗
		16:	9.6	↙
		17:	10.1	↗
		18:	9.9	↓
		19:	10.3	←
		20:	10.3	↑
		Serie		96 (1x)
		Total		188 (2x)

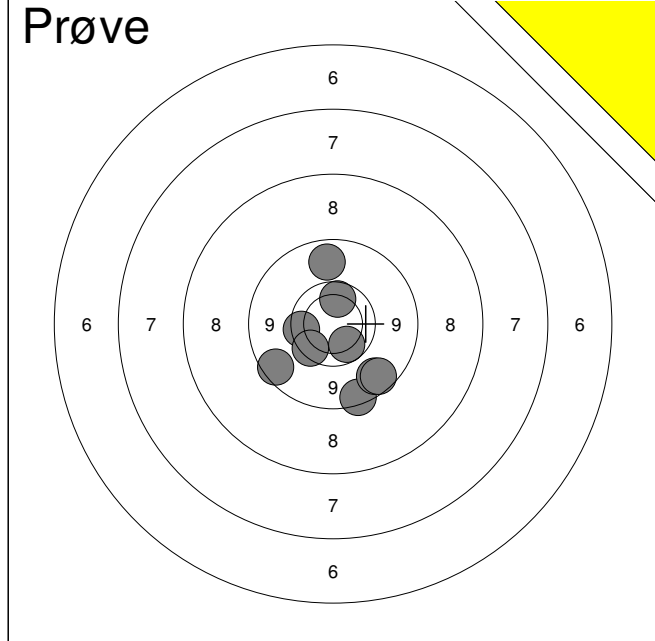

1:	0.0	↗
2:	9.8	←
3:	9.7	↘
4:	8.8	↘
5:	8.9	↘
6:	8.9	←
7:	8.9	↘
8:	9.9	↑
9:	9.9	↘
10:	9.0	↑
Serie		77 (0x)
Total		0 (0x)

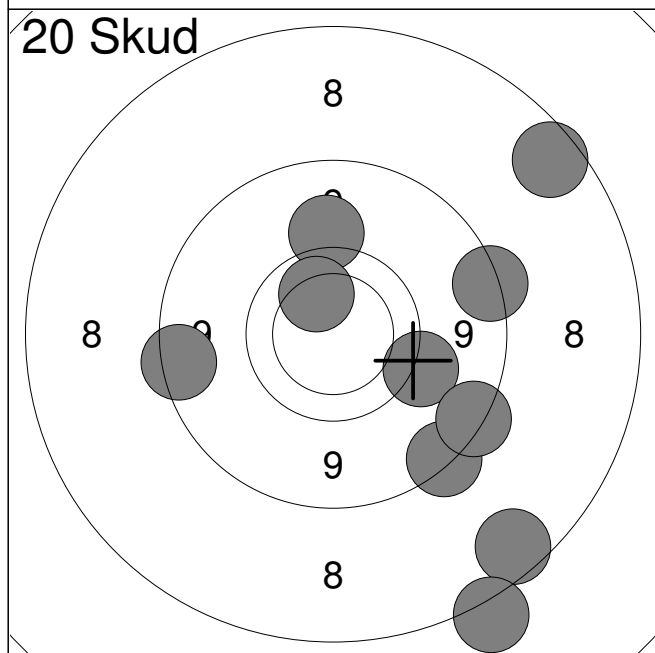

1:	9.4	↘
2:	8.8	←
3:	8.7	↘
4:	9.4	↑
5:	7.9	↗
6:	7.9	↘
7:	8.7	↘
8:	8.7	↗
9:	10.1	↑
10:	7.6	↘
Serie		81 (0x)
Total		81 (0x)

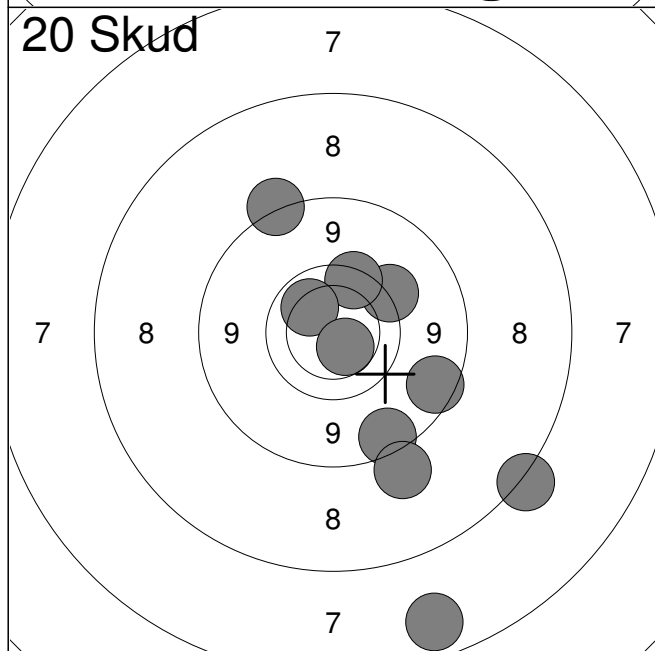

11:	9.5	↗
12:	8.6	↑
13:	7.0	↘
14:	8.8	↘
15:	9.7	↑
16:	8.5	↘
17:	10.1	↗
18:	7.6	↘
19:	10.4	↘
20:	8.9	↘
Serie		84 (0x)
Total		165 (0x)

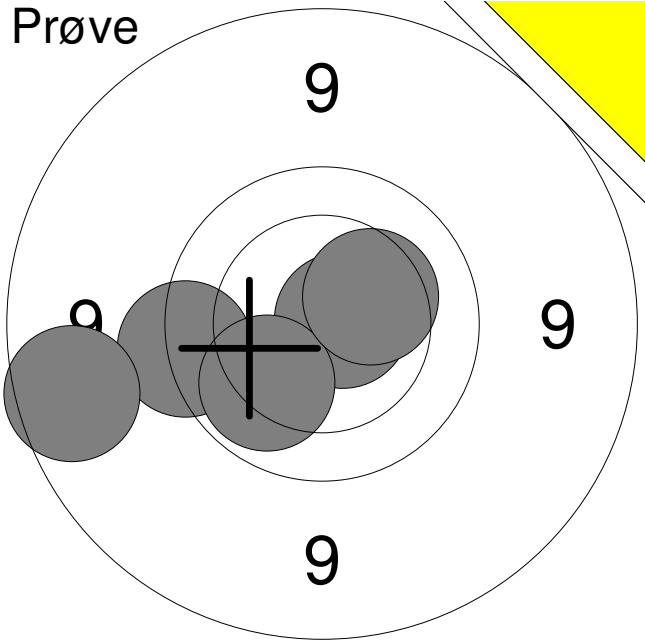
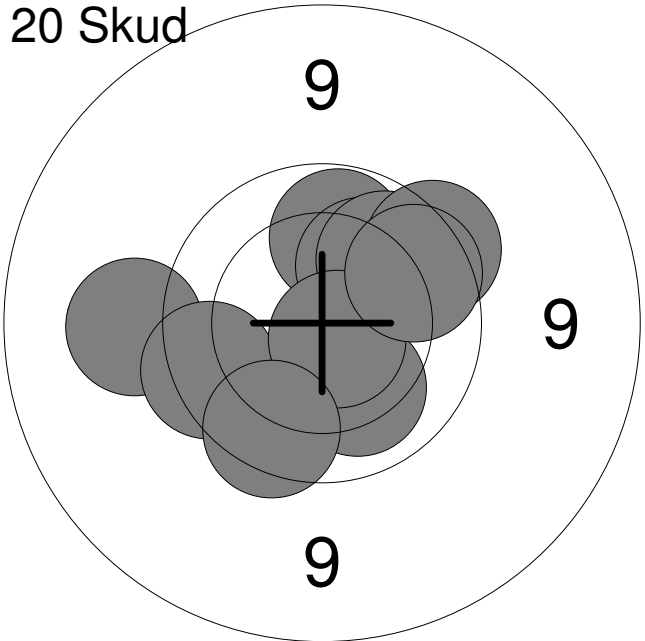
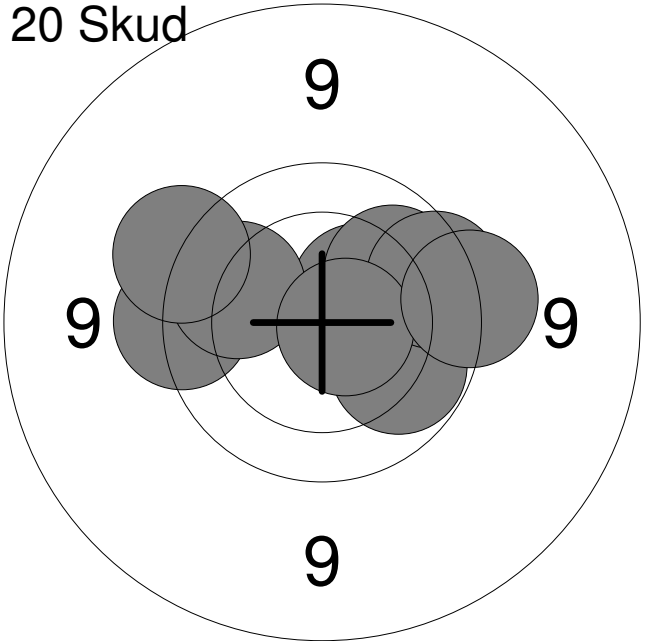
Hold 36	Skive 9	Malthe Andersen		
15 meter		Aalborg Skyttekreds		MJ2
		Nordjysk mesterskab 2019	Aalborg Skyttekreds	
Prøve		1:	9.6	←
		2:	8.9	←
		3:	10.7x	→
		4:	10.1	↙
		5:	10.3	↗
		Serie	47 (1x)	
		Total	0 (0x)	
20 Skud		1:	10.1	↘
		2:	10.0	↑
		3:	10.2	↗
		4:	9.3	←
		5:	10.0	↗
		6:	9.8	←
		7:	10.7x	↘
		8:	9.8	↘
		9:	9.7	↗
		10:	9.9	↗
		Serie	95 (1x)	
		Total	95 (1x)	
20 Skud		11:	9.6	←
		12:	10.0	↘
		13:	10.7x	→
		14:	10.4	↗
		15:	10.0	↗
		16:	9.9	←
		17:	9.8	↗
		18:	9.5	↙
		19:	10.7x	→
		20:	9.6	→
		Serie	95 (2x)	
		Total	190 (3x)	

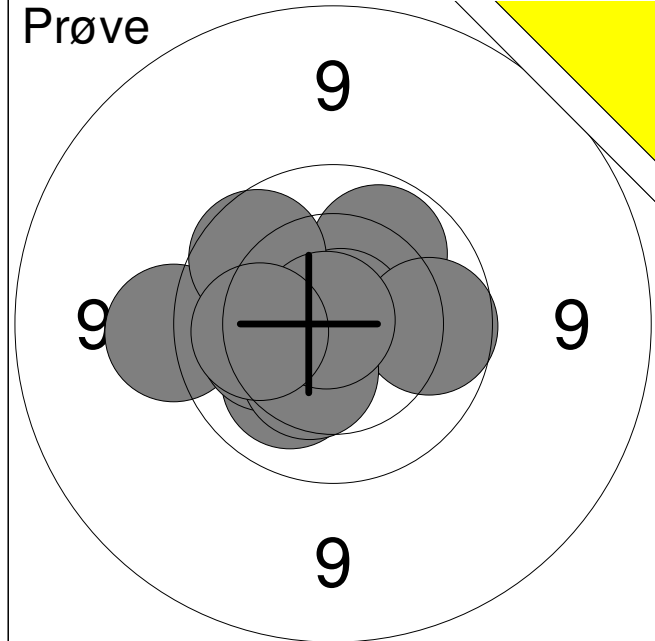

1:	9.5	←
2:	10.2	↓
3:	10.0	↗
4:	10.8x	↗
5:	10.2	←
6:	9.9	↗
7:	9.9	→
8:	10.4	↓
9:	10.9x	↖
10:	10.1	←
Serie		97 (2x)
Total		0 (0x)

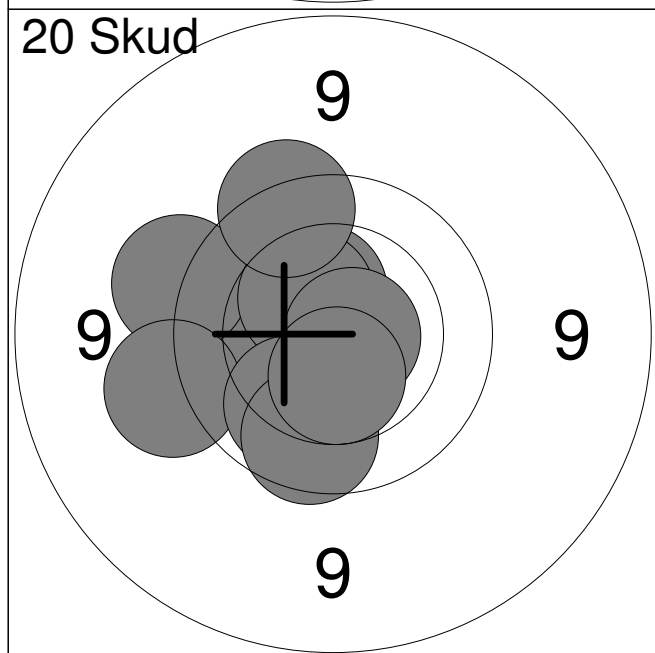

1:	10.0	↖
2:	9.5	←
3:	10.5	↗
4:	10.5	↗
5:	9.5	←
6:	10.1	↓
7:	9.9	↓
8:	10.7x	→
9:	10.5x	↓
10:	9.7	↗
Serie		96 (2x)
Total		96 (2x)

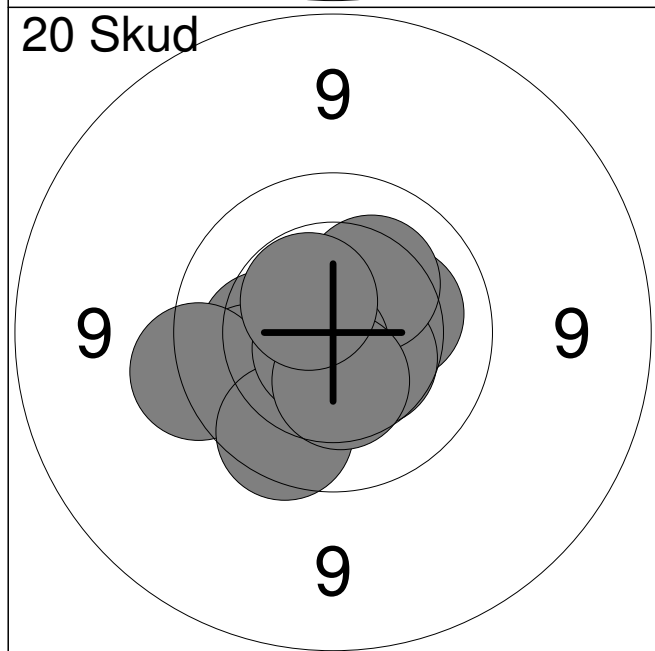

11:	10.2	→
12:	10.2	←
13:	10.5	↓
14:	10.0	←
15:	9.6	←
16:	10.3	↗
17:	9.8	↓
18:	10.7x	↓
19:	10.4	↓
20:	10.5x	↖
Serie		98 (2x)
Total		194 (4x)

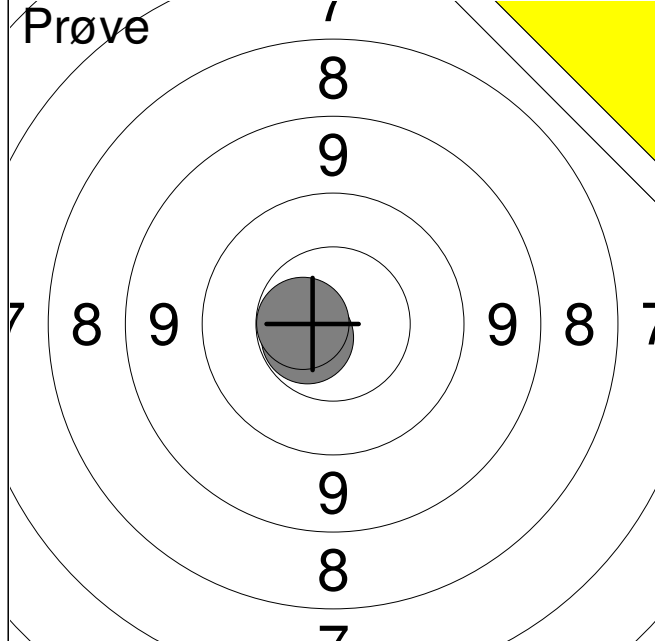

1:	10.6x	↙
2:	10.6x	←
Serie		20 (2x)
Total		0 (0x)

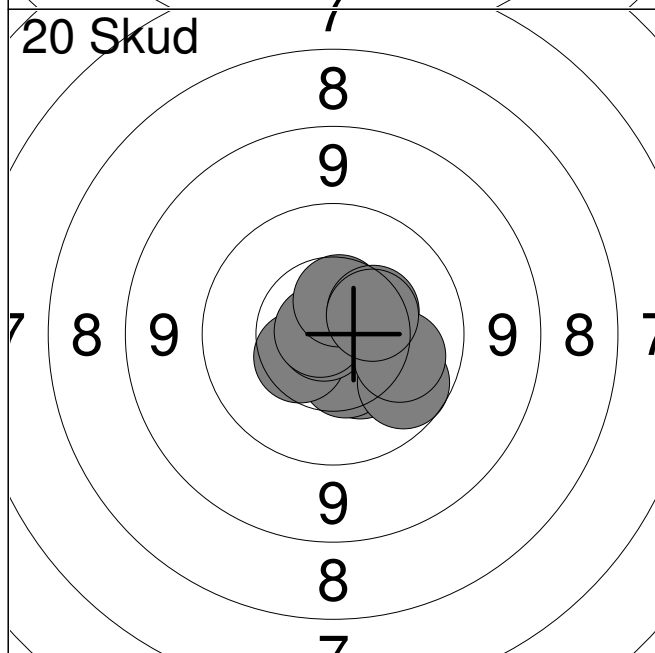

1:	10.4	↘
2:	10.5	↘
3:	10.5	↙
4:	9.9	↘
5:	10.8x	←
6:	10.8x	←
7:	10.5	↑
8:	10.4	↗
9:	10.1	→
10:	10.4	↗
Serie		99 (2x)
Total		99 (2x)

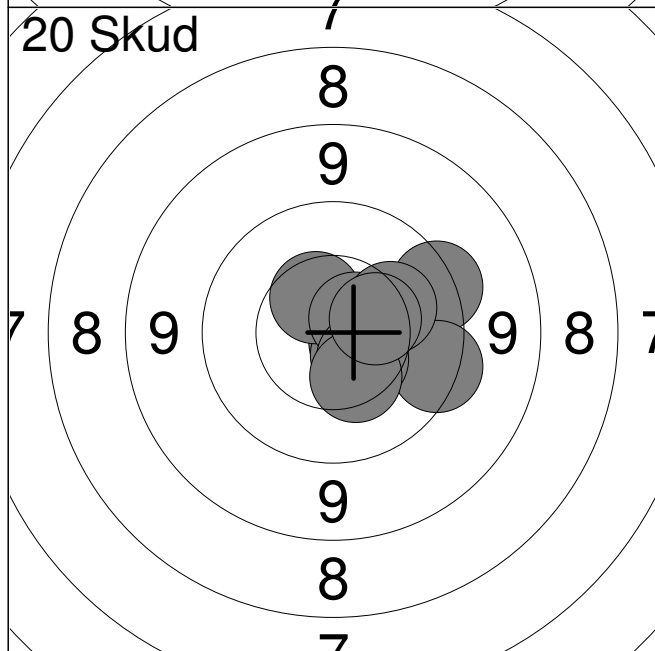

11:	10.7x	↘
12:	10.6	↘
13:	9.6	↗
14:	10.5	↗
15:	10.6x	↗
16:	9.6	→
17:	10.5	↘
18:	10.4	↘
19:	10.2	↗
20:	10.4	→
Serie		98 (2x)
Total		197 (4x)

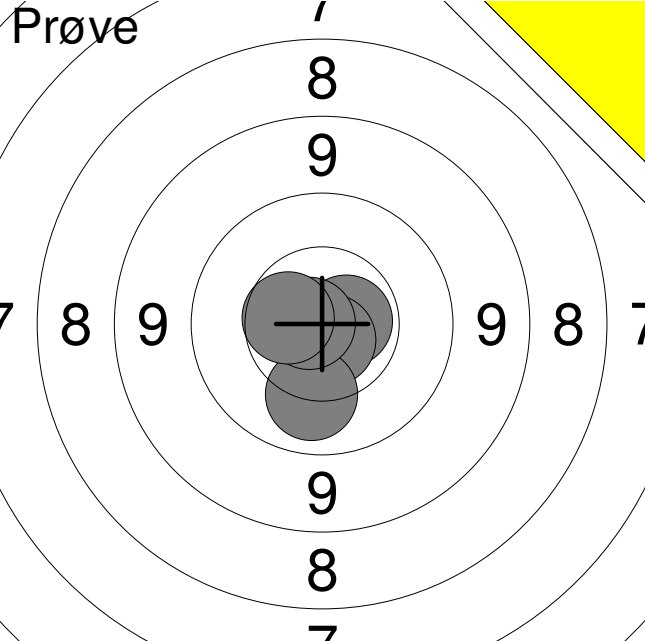
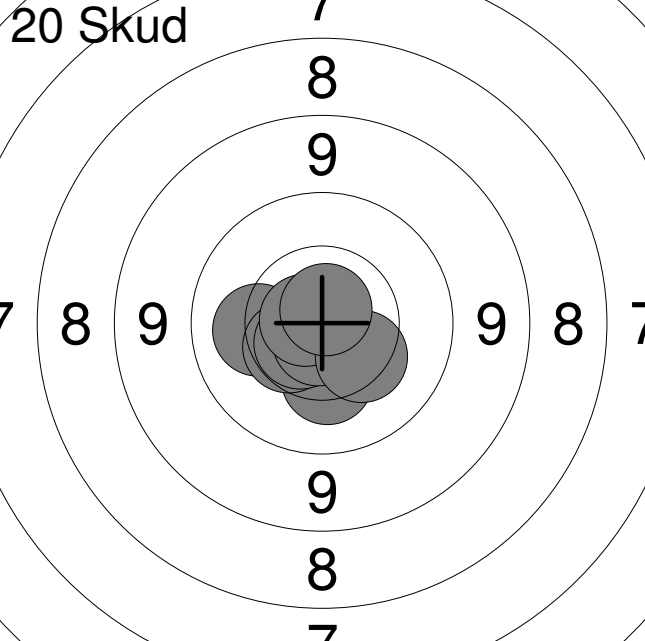
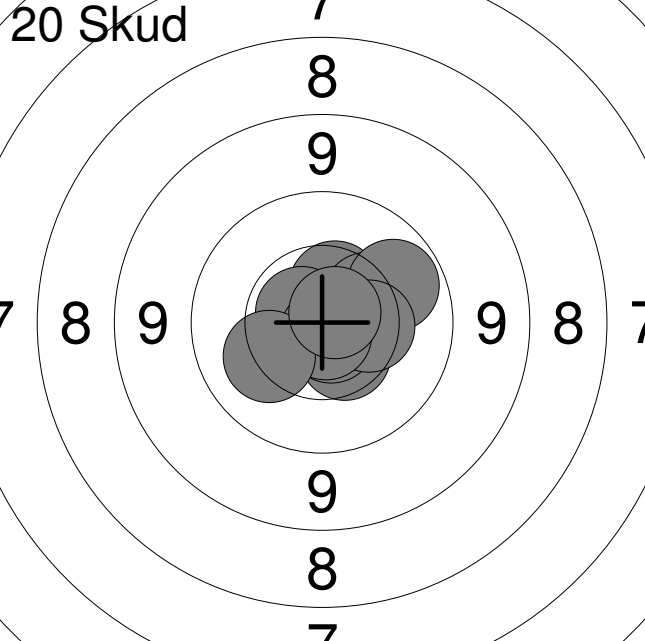
Hold 37	Skive 1	Sune Groen Bendixen		
15 meter		Hjørring Skytteforening		MBK1
		Nordjysk mesterskab 2019	Aalborg Skyttekreds	
Prøve 		1: 10.7x → 2: 10.7x ↓ 3: 10.1 ↓ 4: 10.8x ← 5: 10.5 ←		
		Serie		50 (3x)
		Total		0 (0x)
20 Skud 		1: 10.9x ← 2: 10.3 ↓ 3: 10.2 ← 4: 10.7x ← 5: 10.5 ← 6: 10.6x ← 7: 10.7x ↓ 8: 10.8x ← 9: 10.3 ↘ 10: 10.8x ↑		
		Serie		100 (6x)
		Total		100 (6x)
20 Skud 		11: 10.5 ↑ 12: 10.3 → 13: 10.5 ↓ 14: 10.7x ↓ 15: 10.0 → 16: 10.7x ← 17: 10.4 → 18: 10.8x ↓ 19: 10.2 ← 20: 10.8x ↗		
		Serie		100 (4x)
		Total		200 (10x)

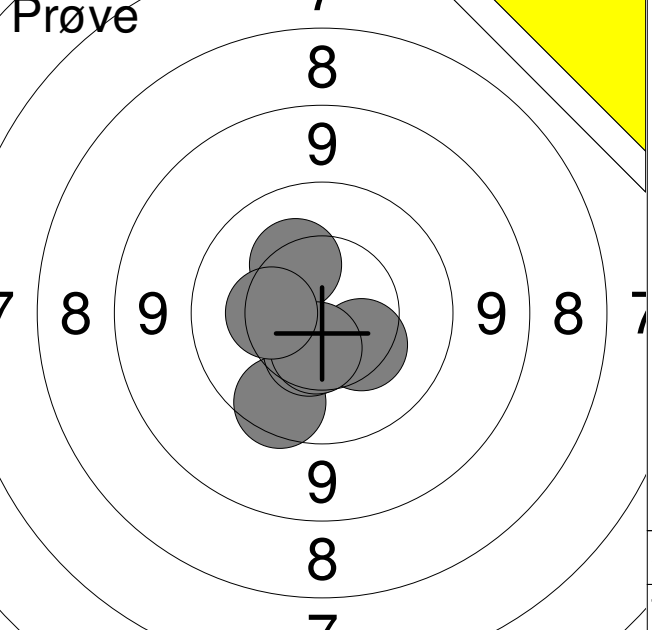
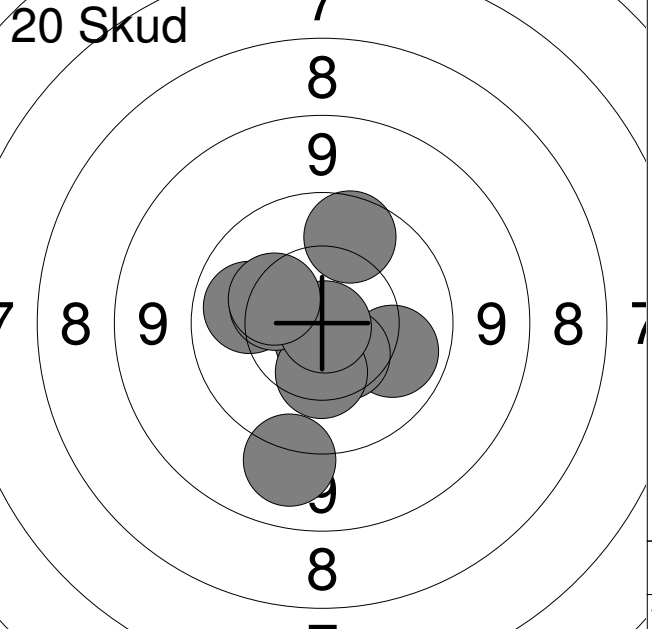
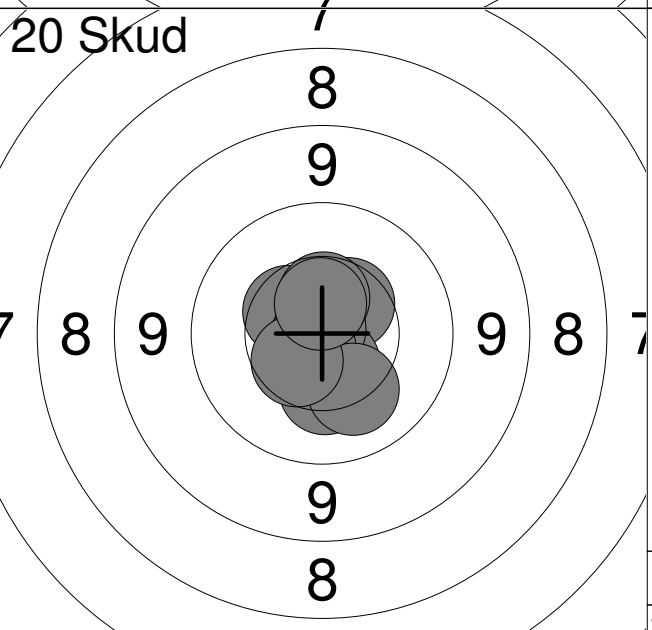
	Nordjysk mesterskab 2019	Aalborg Skyttekreds	
Prøve 		1: 9.8 2: 10.4 3: 10.3 4: 10.5 5: 10.5 6: 10.4	↓ ↘ ↗ ↓ ↓ ←
	Serie	59 (0x)	
	Total	0 (0x)	
20 Skud 		1: 10.8x 2: 10.1 3: 10.5 4: 9.9 5: 9.2 6: 10.1 7: 10.4 8: 10.4 9: 10.9x 10: 10.3	↓ → ↓ ↗ ↓ ← ↓ ↗ ↓ ↗
	Serie	98 (2x)	
	Total	98 (2x)	
20 Skud 		11: 10.5 12: 10.6 13: 10.5 14: 10.9x 15: 10.3 16: 10.7x 17: 10.2 18: 10.5 19: 10.5 20: 10.6x	↗ ↓ ↗ ↗ ↓ ↓ ↓ ↘ ↘ ↑ ↑
	Serie	100 (3x)	
	Total	198 (5x)	

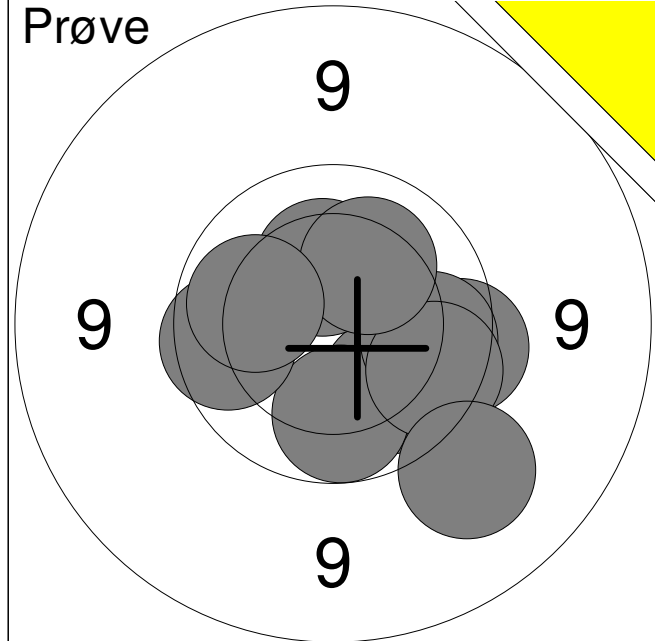

1:	10.0	↘
2:	10.0	↓
3:	9.7	→
4:	9.9	→
5:	10.3	↑
6:	9.8	↘
7:	10.2	↗
8:	9.8	←
9:	9.3	↘
10:	10.1	←
Serie		95 (0x)
Total		0 (0x)

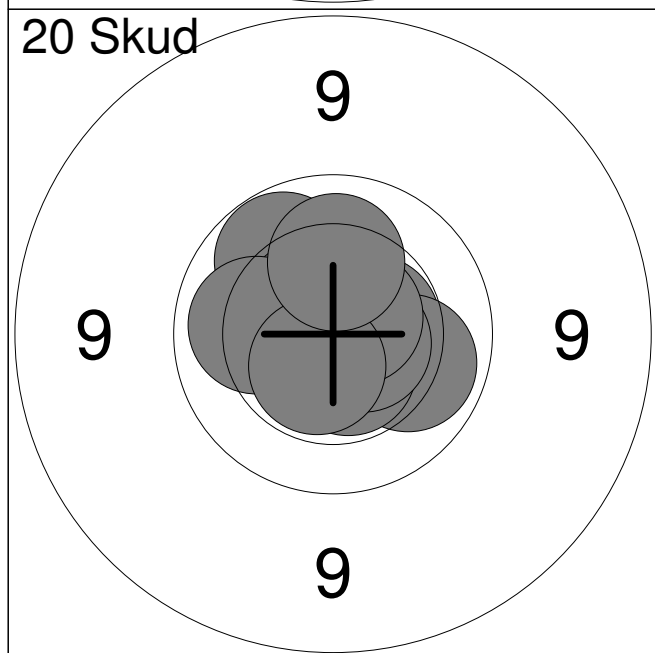

1:	10.5x	→
2:	10.0	↗
3:	10.1	↘
4:	10.6x	↗
5:	10.6x	↓
6:	10.1	←
7:	10.6x	→
8:	10.6x	↗
9:	10.6x	↓
10:	10.2	↑
Serie		100 (6x)
Total		100 (6x)

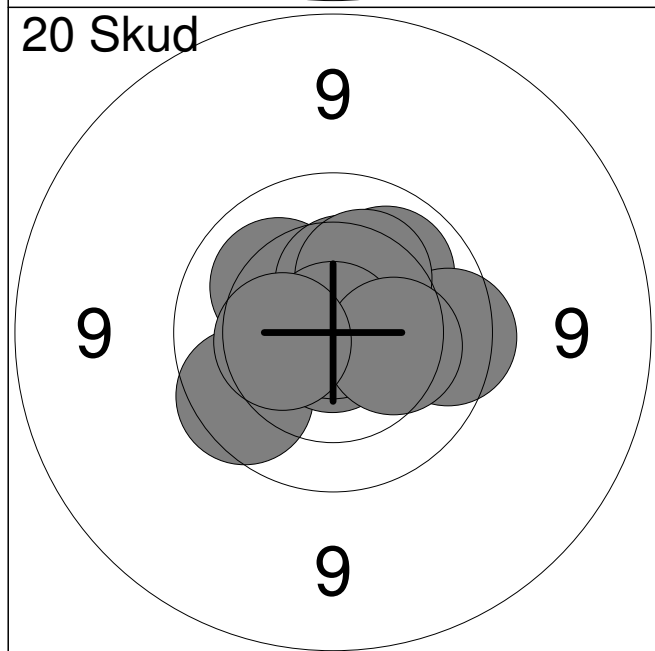

11:	10.2	↖
12:	9.8	←
13:	10.1	↗
14:	10.4	↑
15:	10.8x	↓
16:	9.8	→
17:	10.3	↗
18:	10.9x	↑
19:	10.3	→
20:	10.4	←
Serie		98 (2x)
Total		198 (8x)

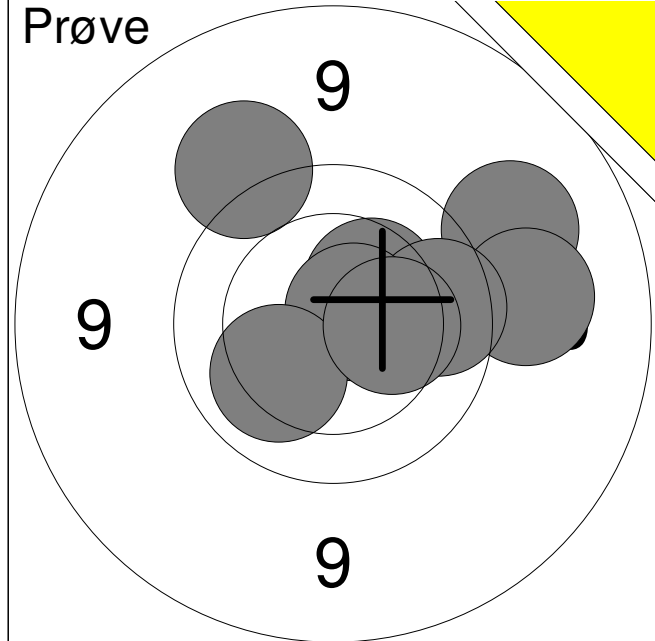

1:	9.3	↗
2:	9.3	→
3:	10.4	↗
4:	9.8	→
5:	10.7x	↗
6:	10.1	↖
7:	9.4	↗
8:	10.3	→
Serie		76 (1x)
Total		0 (0x)

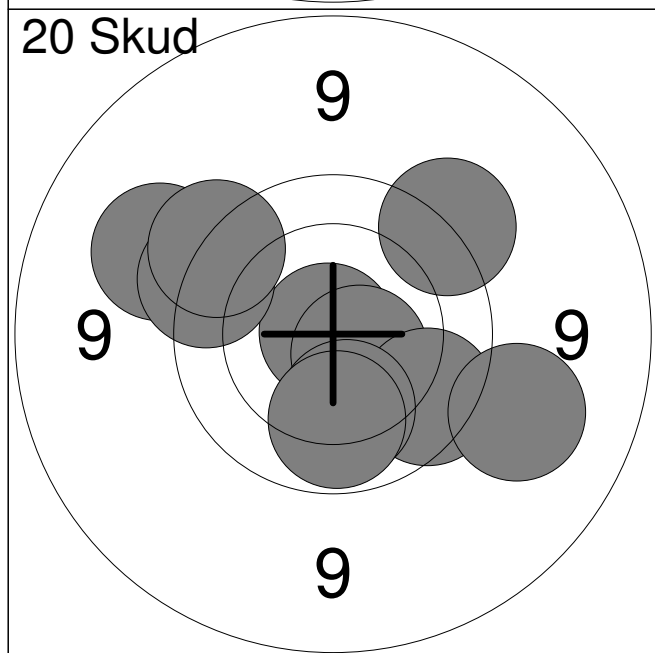

1:	10.9x	↖
2:	9.5	↗
3:	9.3	↖
4:	10.6x	↘
5:	9.8	↘
6:	10.1	↘
7:	9.7	↗
8:	9.6	↗
9:	10.0	↘
10:	9.3	→
Serie		94 (2x)
Total		94 (2x)

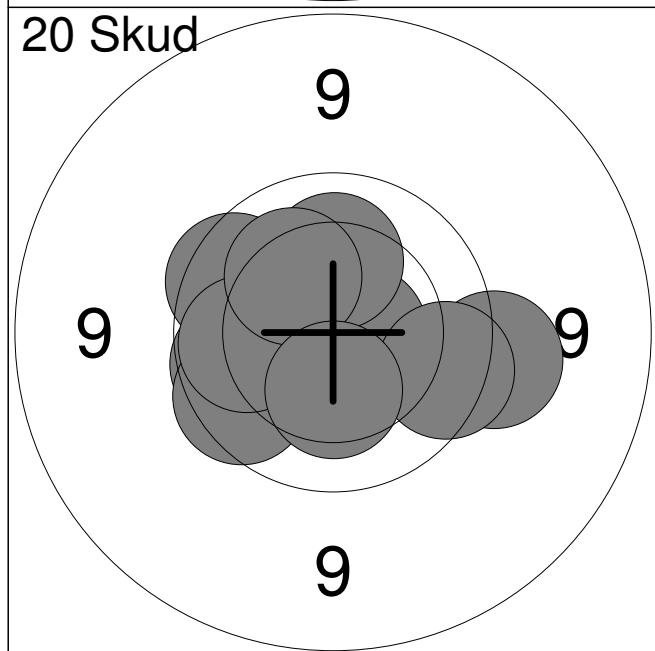

11:	9.9	↖
12:	10.7x	→
13:	10.2	↑
14:	9.5	→
15:	9.8	→
16:	9.8	↖
17:	9.8	↖
18:	10.0	↖
19:	10.2	↗
20:	10.3	↘
Serie		95 (1x)
Total		189 (3x)

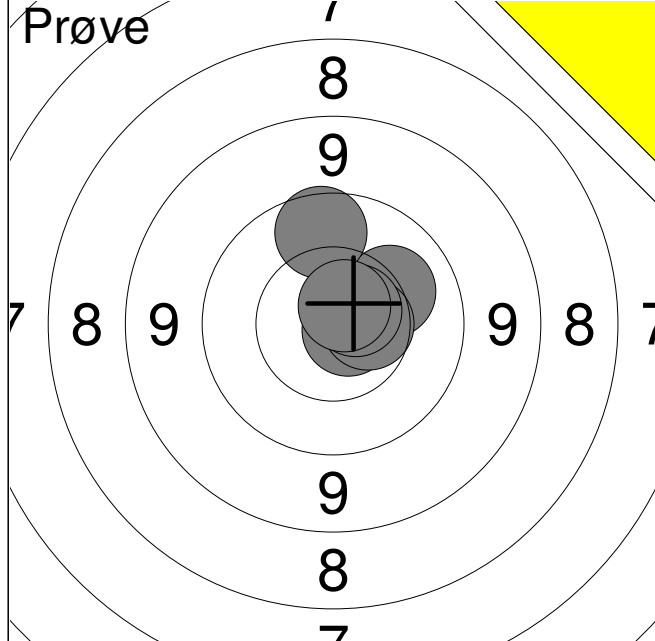

1:	10.8x	➔
2:	10.2	➤
3:	10.5	➔
4:	9.9	↑
5:	10.6x	➤
6:	10.7x	↗
Serie		59 (3x)
Total		0 (0x)

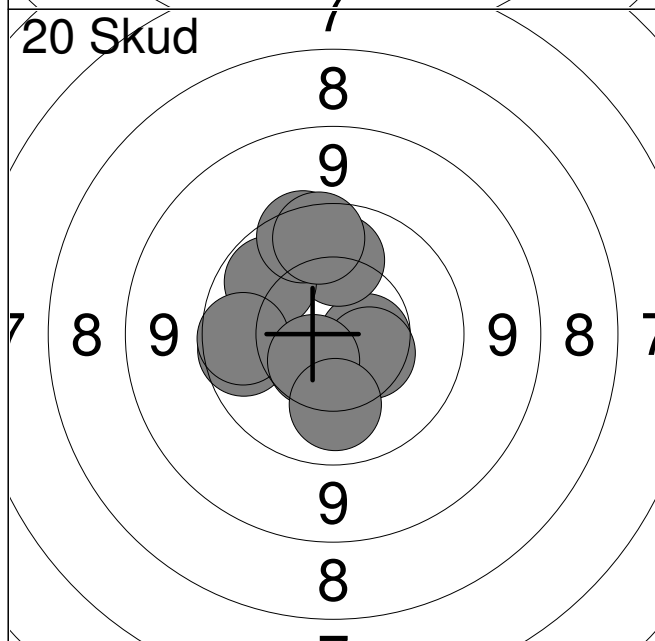

1:	10.6	➔
2:	10.5	➤
3:	10.1	↑
4:	10.0	↗
5:	9.9	←
6:	9.9	←
7:	9.7	↑
8:	9.8	↑
9:	10.6	↙
10:	10.1	↓
Serie		96 (0x)
Total		96 (0x)

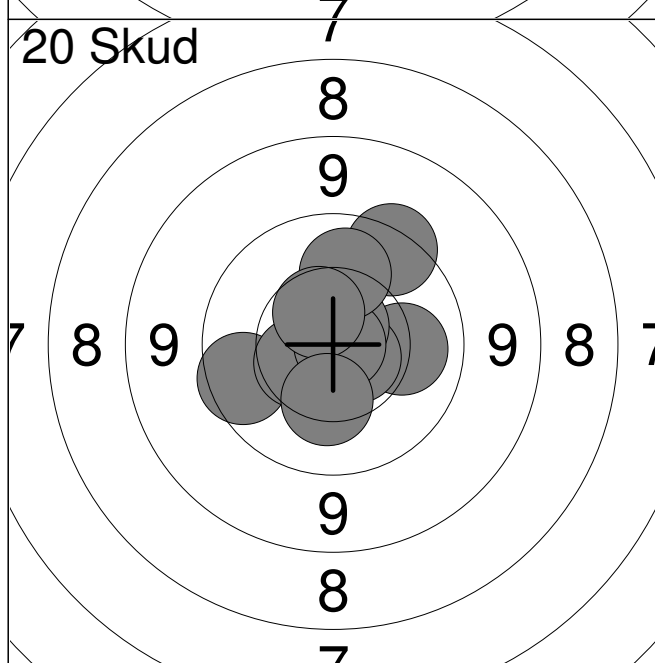

11:	9.8	←
12:	10.1	➔
13:	10.7x	➤
14:	10.7x	↗
15:	9.6	↗
16:	10.5	←
17:	10.9x	➔
18:	10.1	↑
19:	10.5	↗
20:	10.3	↓
Serie		98 (3x)
Total		194 (3x)

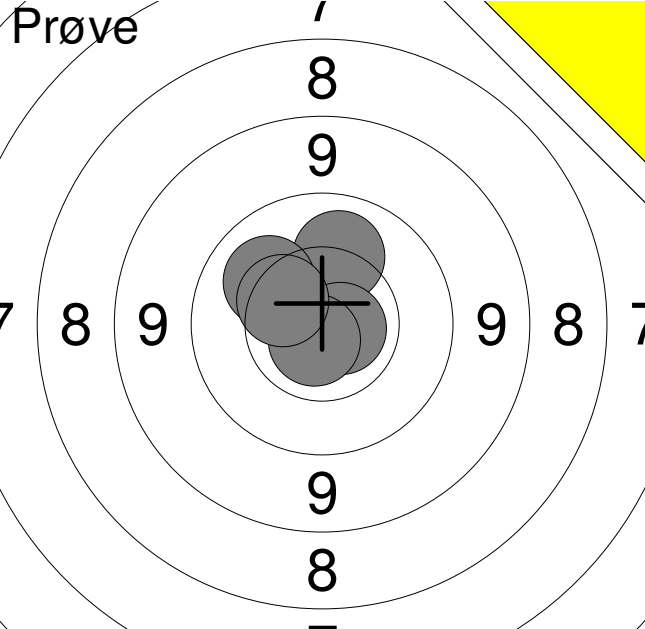
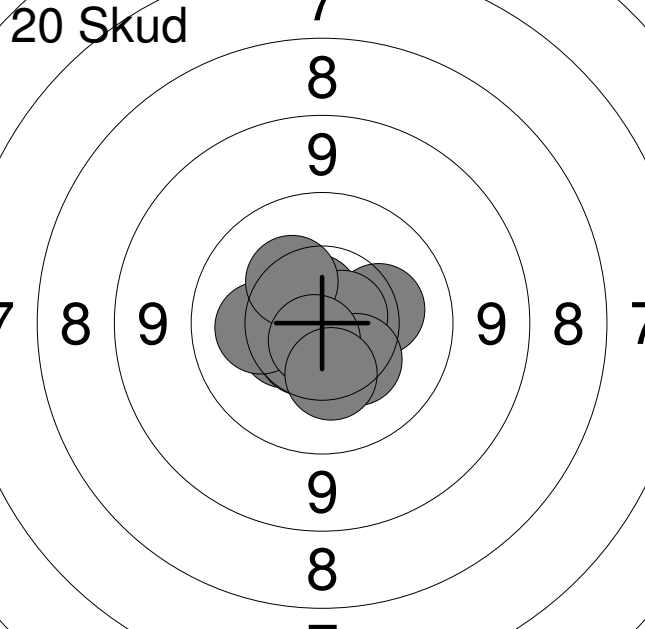
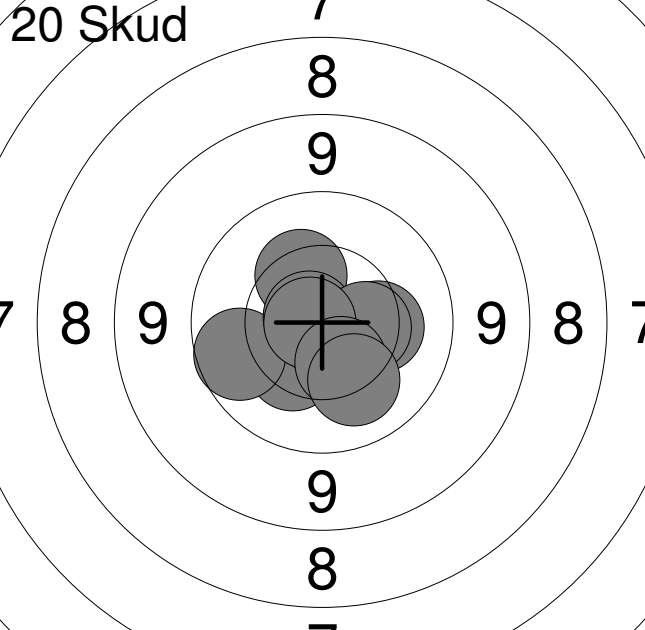
Hold 37	Skive 7	Lai Andersen	
15 meter		Vilsted Skytteforening	MBK2
		Nordjysk mesterskab 2019	Aalborg Skyttekreds
Prøve		1: 10.1	↑
		2: 10.1	↗
		3: 10.7x	→
		4: 10.7x	↘
		5: 10.4	↖
		Serie	50 (2x)
		Total	0 (0x)
20 Skud		1: 10.5	↙
		2: 10.3	→
		3: 10.7x	↑
		4: 10.7x	→
		5: 10.6	↘
		6: 10.2	↖
		7: 10.4	↘
		8: 10.3	↗
		9: 10.7x	↘
		10: 10.3	↓
		Serie	100 (3x)
		Total	100 (3x)
20 Skud		11: 10.3	↘
		12: 9.9	↖
		13: 10.3	↗
		14: 10.8x	↖
		15: 10.8x	↘
		16: 10.3	→
		17: 10.4	→
		18: 10.8x	↖
		19: 10.4	↘
		20: 10.2	↘
		Serie	99 (3x)
		Total	199 (6x)

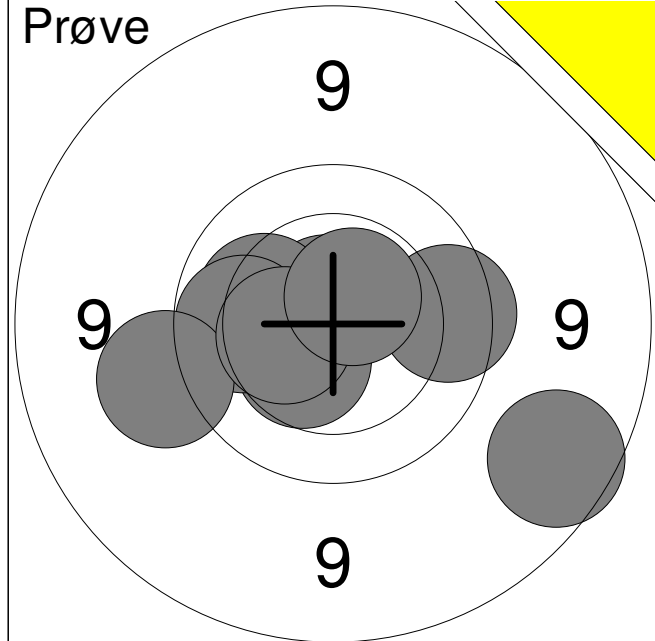

1:	8.9	↘
2:	9.8	→
3:	10.6x	←
4:	10.7x	↑
5:	10.2	←
6:	10.4	↘
7:	10.0	←
8:	9.4	←
9:	10.4	←
10:	10.6x	↗
Serie		96 (3x)
Total		0 (0x)

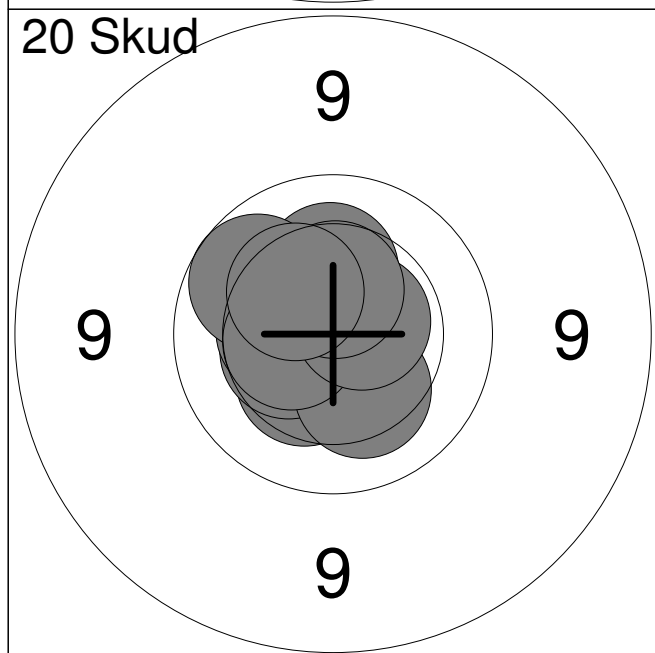

1:	10.4	↘
2:	10.4	←
3:	10.4	←
4:	10.3	↘
5:	10.3	↑
6:	9.9	↗
7:	10.5	←
8:	10.6x	↗
9:	10.5	↑
10:	10.3	↗
Serie		99 (1x)
Total		99 (1x)

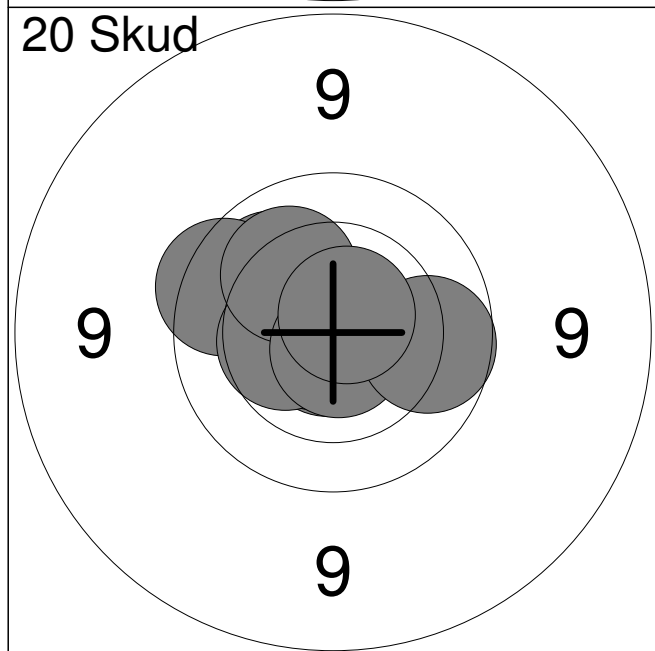

11:	10.8x	↘
12:	10.8x	←
13:	10.1	↗
14:	9.8	←
15:	10.6x	↗
16:	10.4	←
17:	10.2	↗
18:	10.8x	↘
19:	9.9	→
20:	10.7x	↗
Serie		98 (5x)
Total		197 (6x)

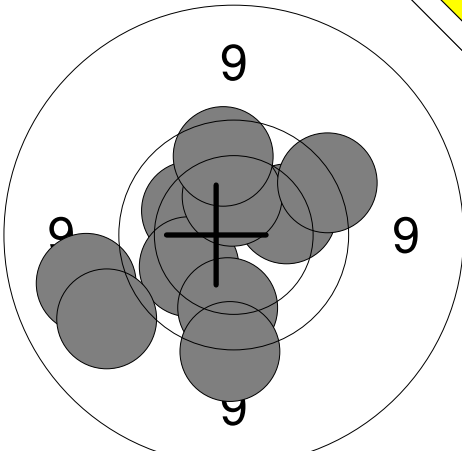
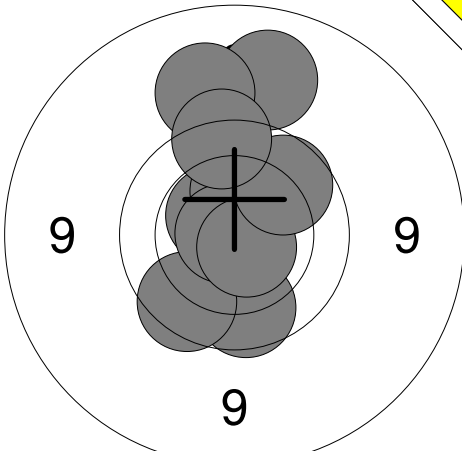
Prøve 0 	1: 10.2 ↖ 2: 10.1 ↙ 3: 10.1 → 4: 10.4 ↑ 5: 9.9 ↓ 6: 9.5 ↓ 7: 9.2 ← 8: 9.2 ↙ 9: 9.8 ↑ 10: 9.6 ↗	Prøve 0 	11: 9.9 ↓ 12: 10.5x ↖ 13: 9.1 ↑ 14: 10.3 ↑ 15: 9.8 ↙ 16: 10.8x ↙ 17: 10.7x ↘ 18: 9.9 ↗ 19: 9.3 ↑ 20: 9.7 ↑
--	---	--	---

Serie 94 (0x)	Serie 94 (3x)
Total 0 (0x)	Total 0 (0x)

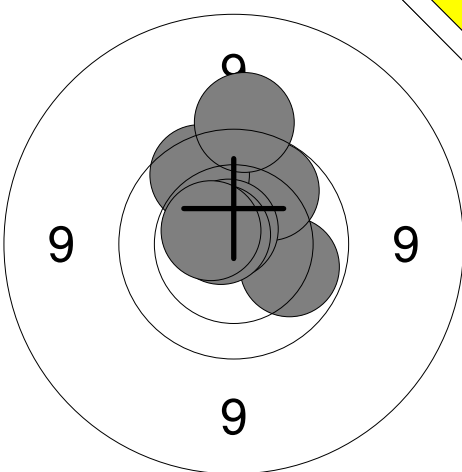
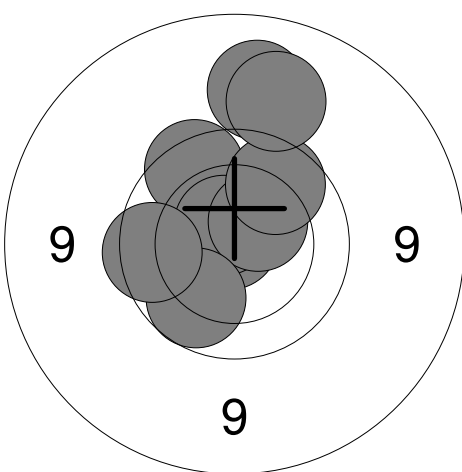
Prøve 0 	21: 10.0 → 22: 10.0 ↗ 23: 9.8 ↗ 24: 10.7x ↗ 25: 9.5 ↑ 26: 10.7x ↖ 27: 10.5x ↖	20 Skud 0 	1: 10.5x ↖ 2: 9.8 ↗ 3: 10.8x ↖ 4: 9.2 ↑ 5: 10.6x ↖ 6: 10.4 ↗ 7: 9.9 ↙ 8: 9.9 ↗ 9: 9.2 ↑ 10: 9.8 ←
---	---	---	--

Serie 68 (3x)	Serie 94 (3x)
Total 0 (0x)	Total 94 (3x)

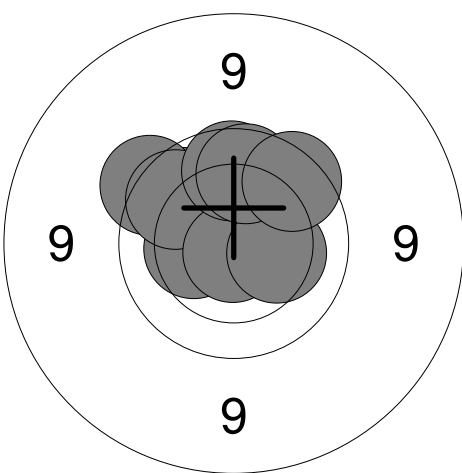
20 Skud 0 	11: 10.2 ↗ 12: 9.9 ↖ 13: 10.3 ← 14: 9.6 ↖ 15: 9.9 ↖ 16: 10.8x ↓ 17: 9.9 ↑ 18: 10.3 → 19: 9.9 ↑ 20: 9.8 ↗		
--	---	--	--

Serie 94 (1x)	
Total 188 (4x)	

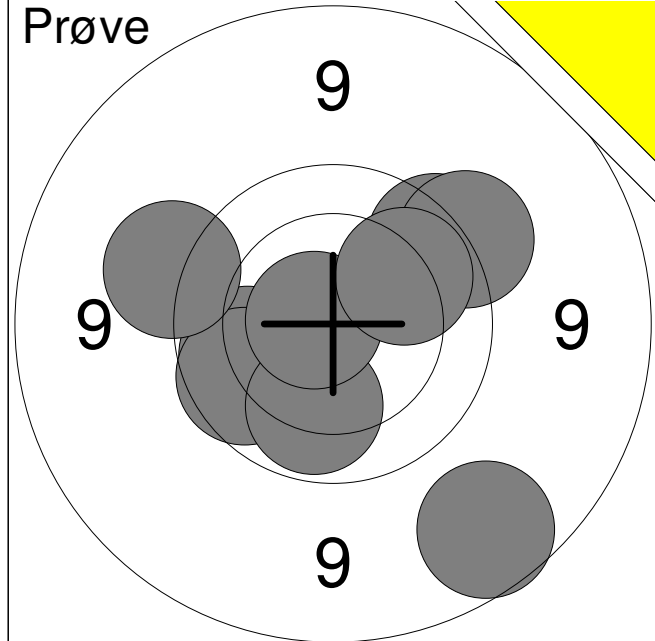

1:	8.9	↘
2:	9.9	←
3:	9.9	←
4:	9.4	←
5:	9.7	↗
6:	10.0	↓
7:	10.7x	←
8:	9.5	↗
9:	10.0	↗
Serie		83 (1x)
Total		0 (0x)

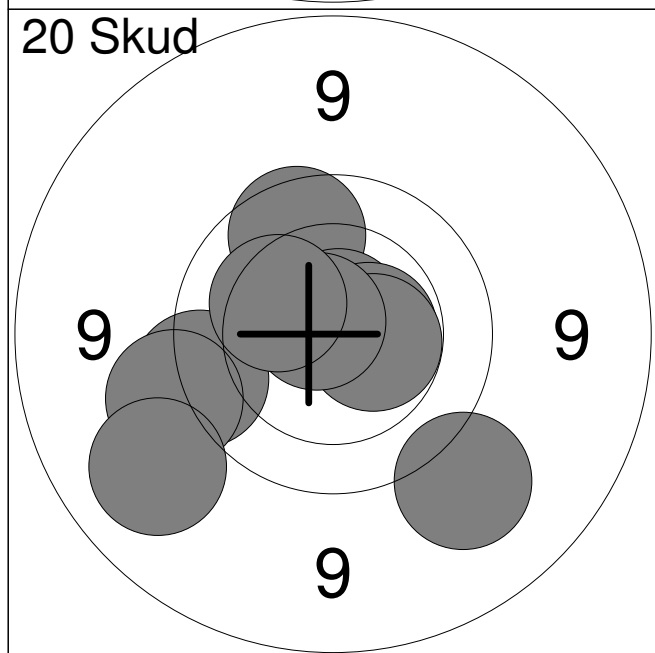

1:	9.6	←
2:	9.9	↑
3:	10.8x	↑
4:	10.6x	→
5:	9.4	←
6:	10.5x	→
7:	9.1	←
8:	9.3	↓
9:	10.7x	↗
10:	10.3	↗
Serie		95 (4x)
Total		95 (4x)

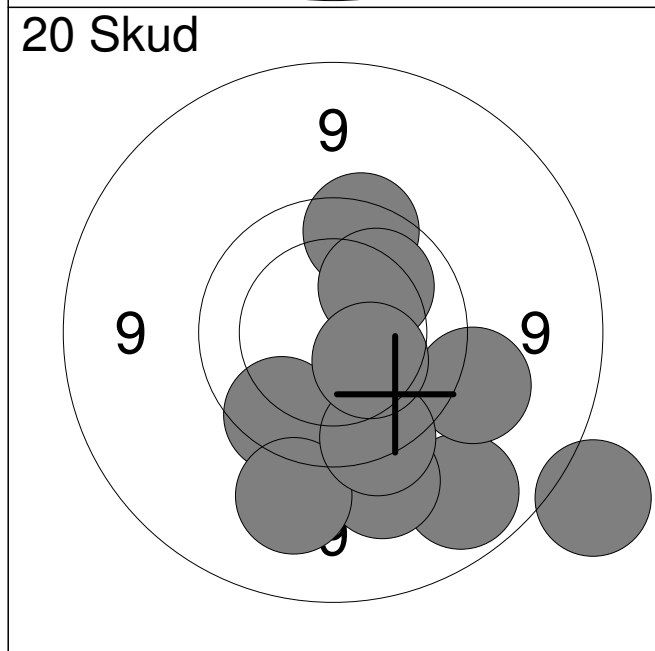

11:	9.0	↘
12:	9.4	↓
13:	9.8	↘
14:	9.4	→
15:	9.7	↑
16:	9.3	↓
17:	9.7	↓
18:	10.1	↗
19:	8.5	↘
20:	10.3	↘
Serie		91 (0x)
Total		186 (4x)

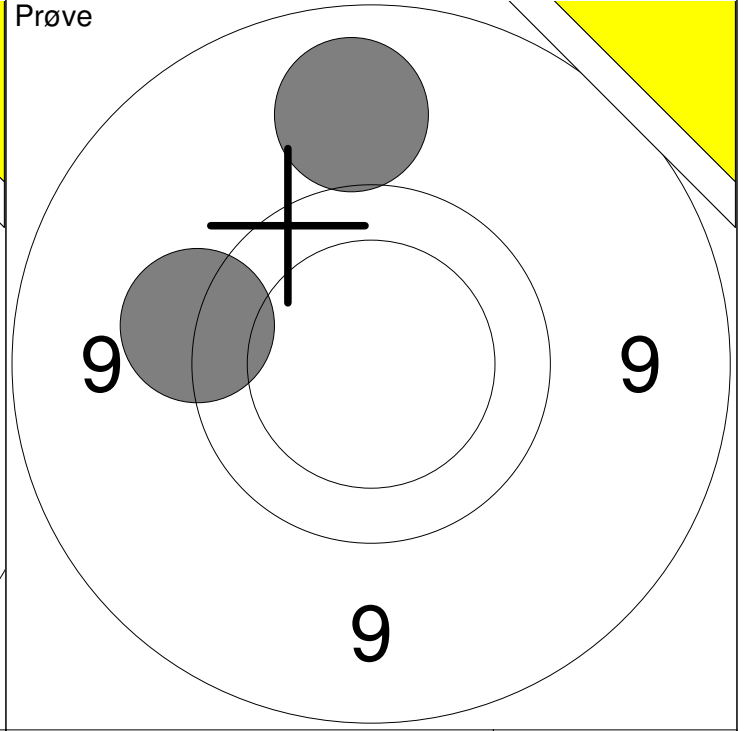
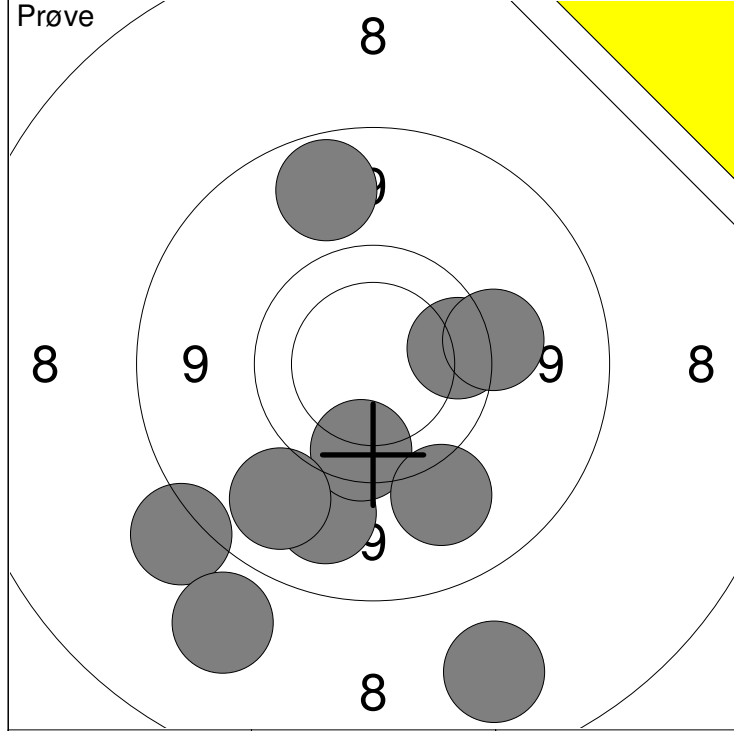

1: 9.0 ↑	6: 9.3 ↓	Serie 87 (0x)
2: 9.8 →	7: 9.5 →	
3: 9.2 ↓	8: 8.6 ↙	Total 0 (0x)
4: 8.2 ↓	9: 8.3 ↓	
5: 9.8 ↓	10: 9.1 ↙	

11: 9.1 ↑	Serie 18 (0x)
12: 9.5 ←	
	Total 0 (0x)

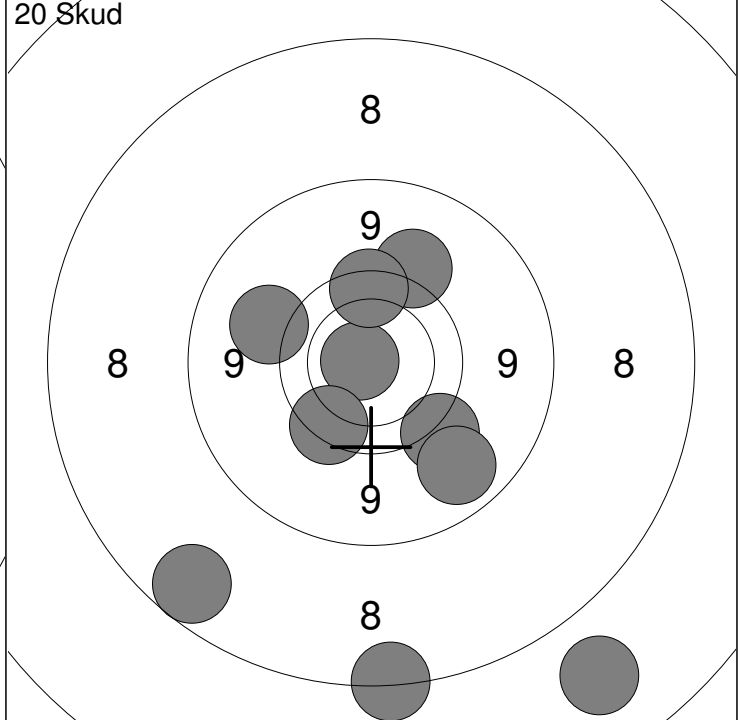
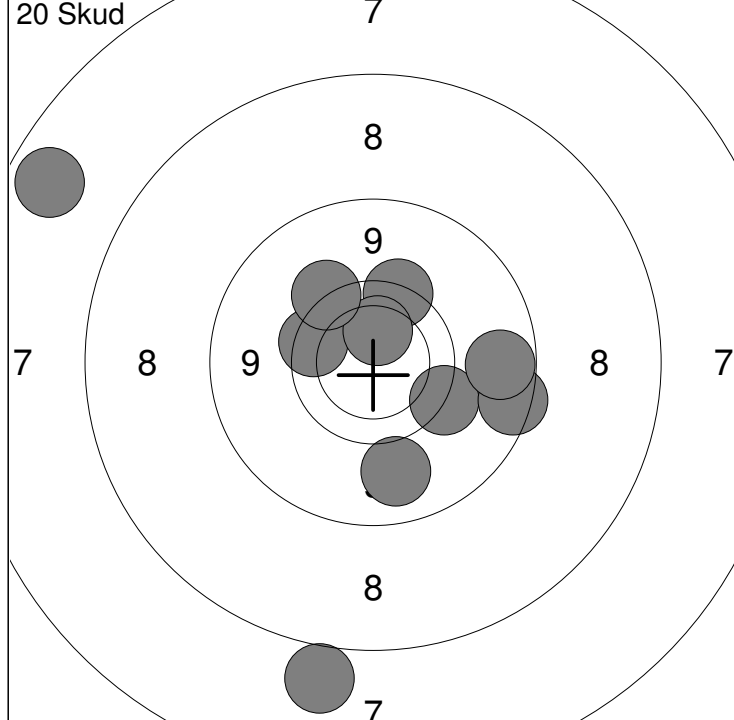

1: 9.5 ↘	6: 9.6 ↑	Serie 86 (0x)
2: 9.7 ↖	7: 10.3 ↑	
3: 8.8 →	8: 9.2 ↓	Total 86 (0x)
4: 9.0 →	9: 9.5 ↗	
5: 7.4 ↓	10: 7.0 ↖	

11: 7.2 ↘	16: 9.1 ↘	Serie 85 (1x)
12: 9.4 ↑	17: 9.7 ↑	
13: 9.4 ↘	18: 7.9 ↘	Total 171 (1x)
14: 7.7 ↓	19: 9.7 ↘	
15: 10.7x ←	20: 9.3 ↖	

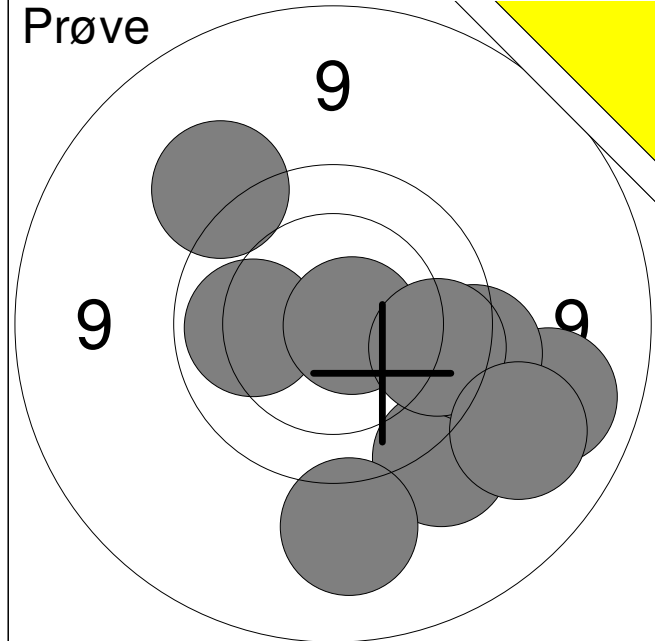

1:	9.1	→
2:	10.1	←
3:	9.4	↘
4:	9.6	→
5:	9.2	↓
6:	9.4	↗
7:	10.7x	→
8:	9.8	→
9:	9.2	↘

Serie 83 (1x)

Total 0 (0x)

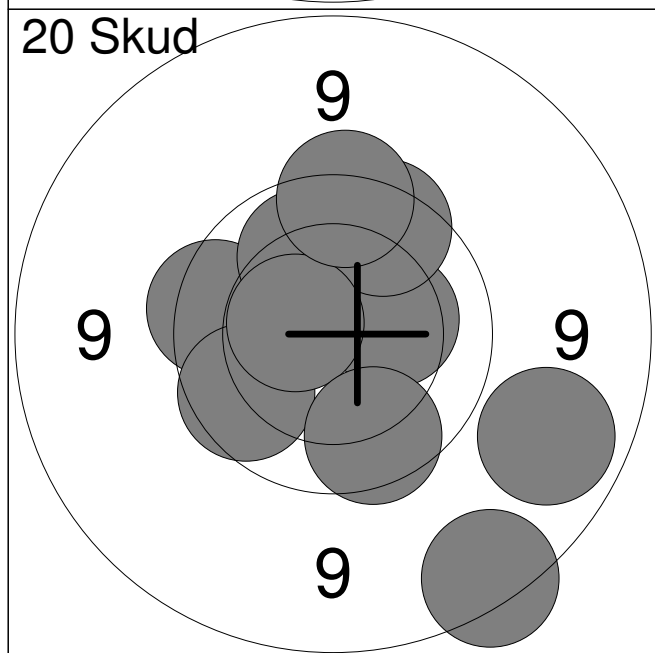

1:	9.8	←
2:	10.0	↑
3:	10.3	→
4:	9.8	↑
5:	9.9	↙
6:	8.8	↘
7:	10.5x	←
8:	9.8	↓
9:	9.7	↑
10:	9.0	↘

Serie 92 (1x)

Total 92 (1x)

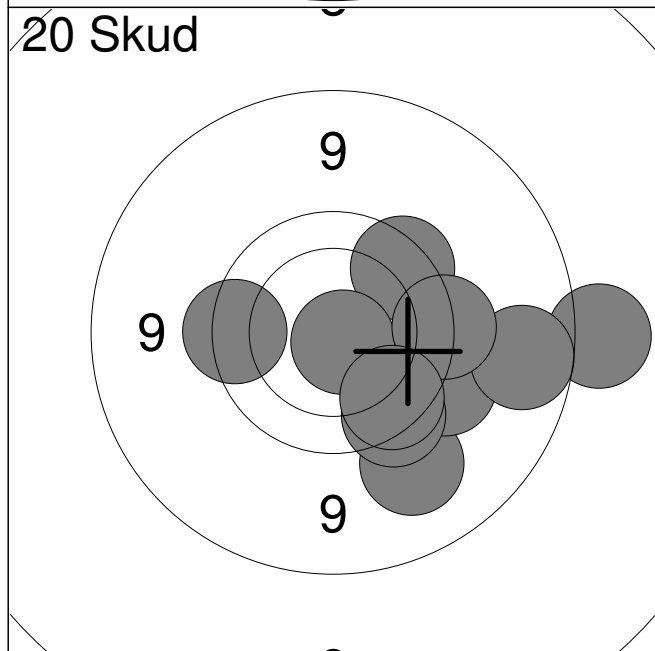

11:	9.3	↘
12:	9.7	←
13:	8.5	→
14:	9.5	↘
15:	9.7	↗
16:	8.9	→
17:	10.7x	↘
18:	9.6	→
19:	9.7	↘
20:	9.8	↘

Serie 89 (1x)

Total 181 (2x)

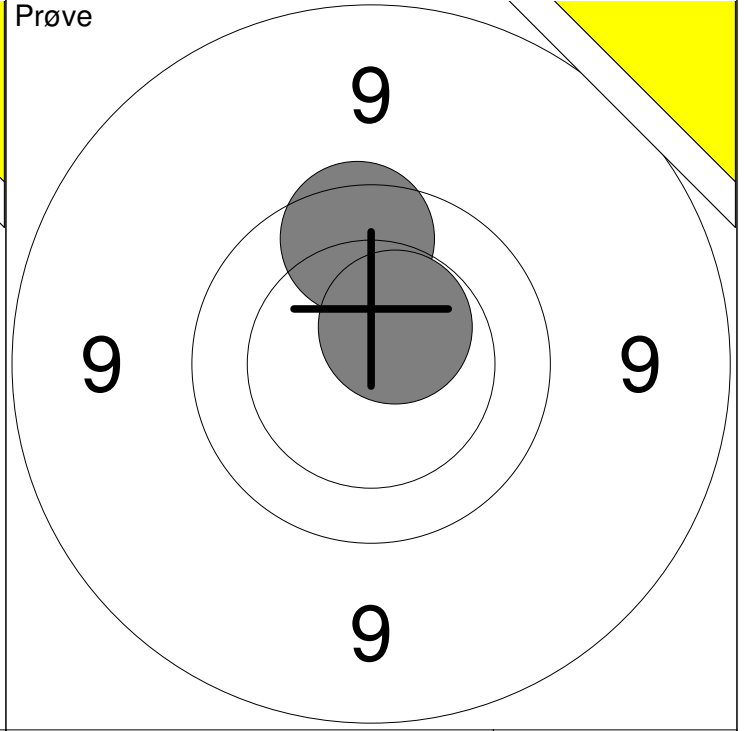
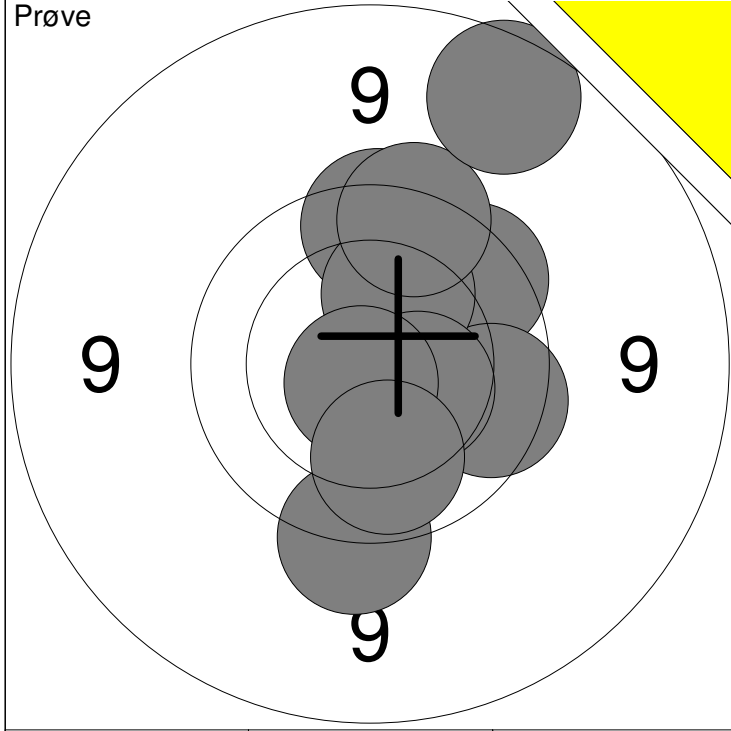

1: 9.8 ↗	6: 9.7 ↑	Serie 93 (1x)
2: 9.8 ➔	7: 8.9 ↗	
3: 9.7 ↑	8: 9.5 ↓	Total 0 (0x)
4: 10.2 ↗	9: 10.7x ↘	
5: 10.4 ➔	10: 10.0 ↓	

11: 9.8 ↑	Serie 19 (1x)
12: 10.5x ↗	
	Total 0 (0x)

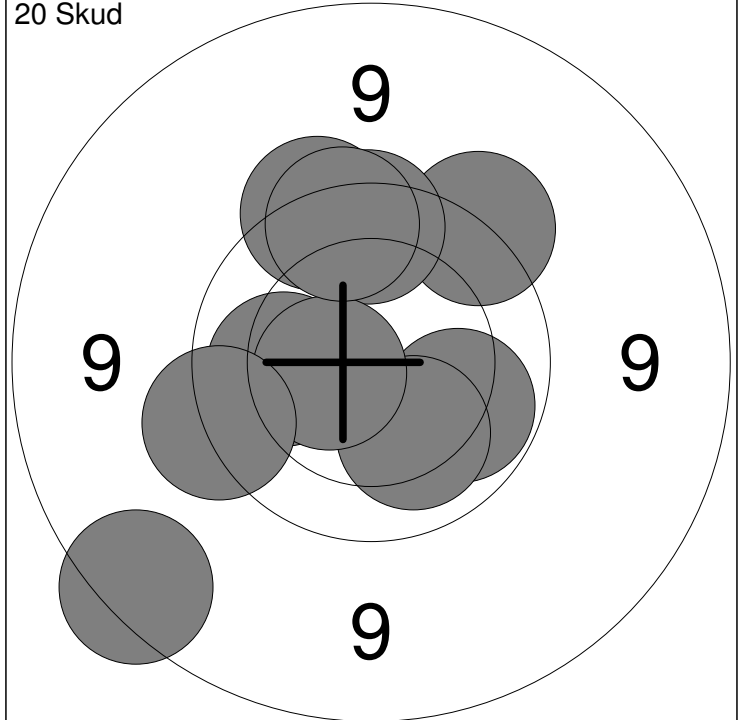
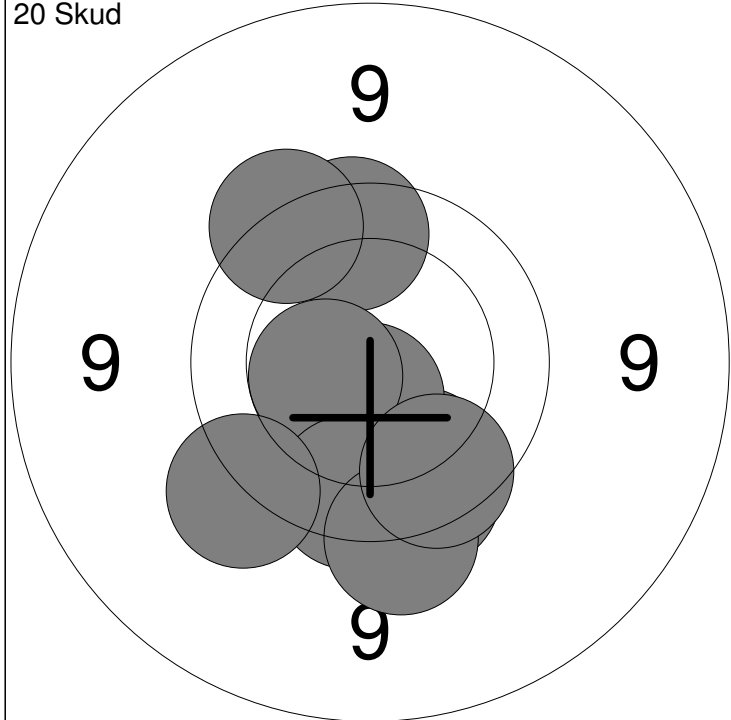

1: 9.9 ↓	6: 10.5x ←	Serie 92 (2x)
2: 9.8 ↑	7: 9.8 ↓	
3: 10.6x ↓	8: 9.5 ↓	Total 92 (2x)
4: 9.6 ↗	9: 9.8 ↓	
5: 9.7 ↓	10: 9.5 ↘	

11: 9.6 ↑	16: 10.1 ←	Serie 93 (1x)
12: 9.6 ↗	17: 10.5x ←	
13: 9.8 ↑	18: 9.7 ↑	Total 185 (3x)
14: 10.0 ➔	19: 8.8 ↘	
15: 10.1 ↓	20: 9.6 ←	